





I/O8+ Serial Adaptors

User Guide

*Part number: 5500031-17
Date: 10 September 2008*

Navigating around this manual

-  ***Using this on-line manual. See page 5.***
-  ***Fast contents. See page 7.***
-  ***Contents. See page 8.***
-  ***Quick reference. See page 111.***
-  ***Index. See page 155.***

Copyright statement

This document must not be reproduced in any way whatsoever, either printed or electronically, without the consent of:

Perle Systems Limited,
60 Renfrew Drive
Markham, ON
Canada
L3R 0E1

Perle reserves the right to make changes without further notice, to any products to improve reliability, function or design.

Specialix, the Specialix logo, JETSTREAM, JETSTREAM4000, JETSTREAM8500 and LANSTREAM2000 are trademarks of Perle Systems Limited.

Microsoft, Windows 95, Windows 98, Windows NT, Windows 2000, Window XP, Windows Server 2003, Windows Vista, Windows Server 2008, and Internet Explorer are trademarks of Microsoft Corporation.

Netscape is a trademark of Netscape Communications Corporation.

Solaris is a registered trademark of Sun Microsystems, Inc. in the USA and other countries.

Perle Systems Limited, 10 September 2008.

FCC Note

The products described in this manual have been found to comply with the limits for a Class A digital device, pursuant to Part 15 of the FCC rules. These limits are designed to provide reasonable protection against harmful interference when the equipment is operated in a commercial environment. This equipment generates, uses and can radiate radio frequency energy and, if not installed and used in accordance with the instructions in this Guide, may cause harmful interference to radio communications. Operation of this equipment in a residential area is likely to cause harmful interference, in which case the user will be required to correct the interference at his/her own expense.

EN 55022: 1998, Class A Note

Warning: This is a Class A product. In a domestic environment this product may cause radio interference in which case the user may be required to take adequate measures.



Caution: The products described in this manual are approved for commercial use only.

About this manual

Purpose of this manual

This manual tells you how to install, configure and use the Perle I/O8+ ISA and PCI serial adaptor cards, associated drivers and utilities.

Who this manual is for

This manual is aimed at users who want to add extra serial ports to their system using I/O8+ ISA and PCI serial adaptor cards. This manual requires a working knowledge of using personal computers and associated operating systems, as well as experience in installing host cards.



Warning

Dangerous voltages exist inside computer systems. Before installing host cards in your system, turn off the power supply and disconnect the mains lead.

Using this on-line manual

The following is a brief guide to using this manual on-line.

Document navigation

This manual features document navigation hypertext buttons in the header area as shown in the next picture;

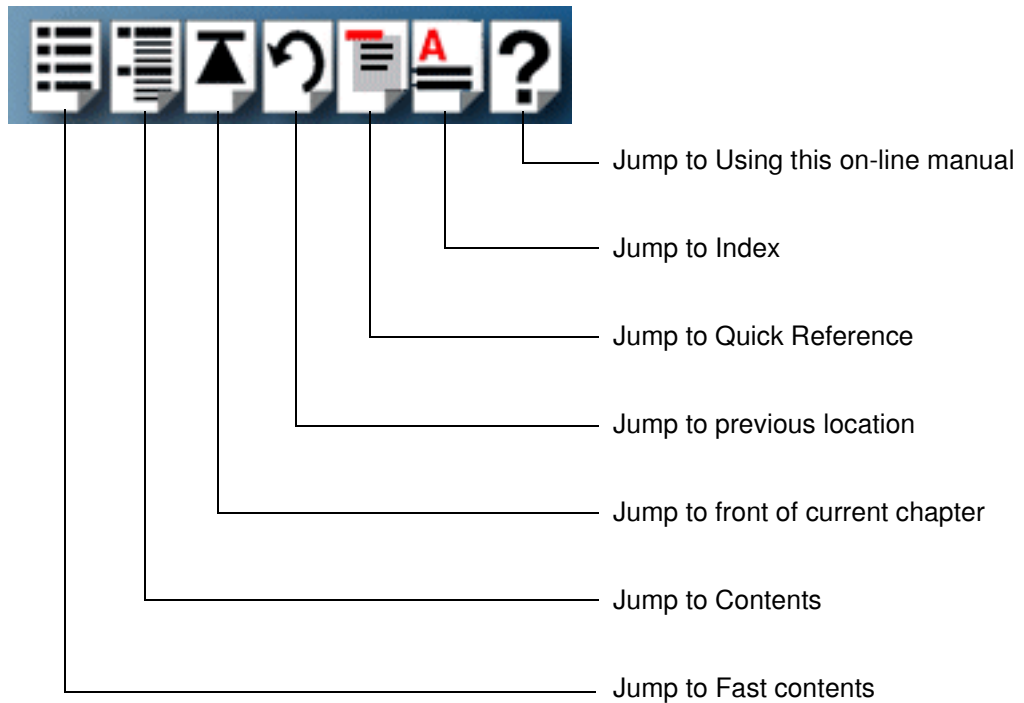

Hypertext jumps

You can also navigate around this manual by clicking on any cross reference or text in blue for example, [Hypertext jumps](#).

Note

The **Fast Contents**, **Contents** and **Index** entries are all hypertext jumps into this manual.

Revision history

Date	Part number	Description
June 1999	5500031-10	First issue of new I/O8+ user manual replacing Installation guide 42-700001. Includes details of drivers, utilities and installation under the SCO OpenServer 5 operating system.
August 1999	5500031-11	Update of manual to include drivers, utilities and installation under the SCO UnixWare operating system.
March 2000	5500031-12	Update of manual to include drivers, utilities and installation under the Windows 95 and 98 operating systems.
September 2000	5500031-13	Update of manual to include drivers, utilities and installation under the Windows NT and Windows 2000 operating systems.
November 2001	5500031-14	Update of manual to include new contact details and some re-branding.
October 2002	5500031-15	Removal of part numbers from Cabling chapter.
January 2006	5500031-16	Added information for OpenServer 6 support.
September 2008	5500031-17	Added information for Windows XP/Server 2003/Vista/Server 2008.

Fast contents

<i>ABOUT THIS MANUAL</i>	4
<i>REVISION HISTORY</i>	6
<i>FAST CONTENTS</i>	7
<i>CONTENTS</i>	8
<i>CHAPTER 1 INTRODUCTION</i>	15
<i>CHAPTER 2 INSTALLING DRIVERS AND HOST CARDS</i>	17
<i>CHAPTER 3 I/O8+ CABLING INFORMATION</i>	105
<i>CHAPTER 4 QUICK REFERENCE</i>	111
<i>APPENDIX A SERIAL PORT DEVICE NAMES</i>	119
<i>APPENDIX B TRANSPARENT PRINTING</i>	122
<i>APPENDIX C ISA HOST CARD ADDRESS SETTINGS</i>	126
<i>APPENDIX D TROUBLESHOOTING</i>	131
<i>APPENDIX E CONTACTING PERLE</i>	149
<i>INDEX</i>	155

Contents

ABOUT THIS MANUAL	4
<i>Purpose of this manual</i>	<i>4</i>
<i>Who this manual is for</i>	<i>4</i>
<i>Using this on-line manual</i>	<i>5</i>
<i>Document navigation</i>	<i>5</i>
<i>Hypertext jumps</i>	<i>5</i>
REVISION HISTORY	6
FAST CONTENTS	7
CONTENTS	8

CHAPTER 1 INTRODUCTION

15

About the I/O8+ serial adaptor card 16

CHAPTER 2 INSTALLING DRIVERS AND HOST CARDS 17

Before you start	18
Downloading I/O8+ drivers from the Perle web site	18
Installing I/O8+ under Windows 95 and 98	19
General installation procedure for Windows 95 and 98	19
Installing device drivers and utilities.....	20
Adding ISA host cards to the system	22
Configuring I/O8+ serial ports	28
Removing I/O8+ hardware from your system	31
Installing under Windows NT	33
Installing I/O8+ under SCO OpenServer	34
General installation procedure for SCO OpenServer.....	34
Upgrading from existing device drivers.....	36
Upgrading from Specialix combined driver 2.0.2 for SCO Unix 3.2.4 (SCO OpenServer 5 Only)	36
Upgrading your current I/O8+ device driver (SCO OpenServer 5 Only)	36
Installing device drivers and utilities.....	37
Assigning ISA host card addresses and IRQ levels (SCO OpenServer 5 Only)	43
Starting the Host Card Configuration utility	44
Adding a new host card address	45
Editing a host card address	47
Removing a host card address	49
Exiting the Host Card Configuration utility	50
Configuring I/O8+ serial ports	51
Removing I/O8+ drivers and utilities from your system.....	55
Installing I/O8+ under SCO UnixWare	57
General installation procedure for SCO UnixWare	58
Upgrading from existing device drivers.....	60
Upgrading from Specialix I/O8+ Svr4 driver v1.0.2	60
Installing drivers and utilities onto your system.....	61
Assigning ISA host card addresses and IRQ levels.....	64
Starting the Unixware Device Configuration Utility	65
Adding a new host card address	67
Editing a host card address	69
De-activating a host card	70
Displaying software device driver details	71
Exiting the Device Configuration Utility	72
Configuring serial ports	73
Configuring serial ports under SCO UnixWare 2	78
Removing I/O8+ drivers and utilities from your system.....	79

Installing an I/O8+ PCI host card under Windows 2000/XP/Server 2003/ Vista/Server 2008	80
General PCI host card installation procedure for Windows 2000/XP/Server 2003/Vista/Server 2008.....	80
Installing PCI host card device drivers and utilities onto your system	81
Updating I/O8+ PCI host card device drivers with update.exe.....	83
Configuring PCI host card serial ports	85
Installing an I/O8+ ISA host card under Windows 2000	88
General ISA host card installation procedure for Windows 2000.....	88
Adding ISA host cards to the system	89
Viewing and changing the ISA host card resources for a device.....	93
Updating I/O8+ ISA host card device drivers with update.exe.....	97
Configuring ISA host card serial ports	98
Installing a PCI host card	100
Installing an ISA host card	101
Removing host cards	103

CHAPTER 3 I/O8+ CABLING INFORMATION 105

- RJ12 socket pinouts on I/O8+ host cards 106***
- I/O8+ cables available from Perle 107***
 - RJ12 to DB9 male cable 108*
 - Cable diagram 108*
 - Connector pinout table 108*
 - RJ12 to DB25 male cable 109*
 - Cable diagram 109*
 - Connector pinout table 109*
 - RJ12 to DB25 female cable 110*
 - Cable diagram 110*
 - Connector pinout table 110*

CHAPTER 4 QUICK REFERENCE	111
SCO OpenServer utilities	112
Host Card Configuration utility (SCO OpenServer 5 Only)	113
Port Configuration utility	114
SCO UnixWare utilities	116
Device configuration utility	116
Serial Manager	117
APPENDIX A SERIAL PORT DEVICE NAMES	119
Under SCO OpenServer	120
Device node details	120
DTR and RTS signal information	120
Under SCO UnixWare	121
Device node details	121
APPENDIX B TRANSPARENT PRINTING	122
What is transparent printing?	123
Problems with printer output	124
The printcap.io8 configuration file	124
The print.io8 configuration file	125
APPENDIX C ISA HOST CARD ADDRESS SETTINGS	126
DIL switch location	127
Hexidecimal to binary conversion table	128
APPENDIX D TROUBLESHOOTING	131
Windows 95 and 98	132
Resource conflicts	132
Re-allocating system resources	136
Re-allocating resources from the BIOS	136
Re-allocating resources using Device Manager	137
Windows NT	140
Windows NT general troubleshooting	140

SCO OpenServer 5	141
<i>Example of normal boot up messages for host cards.....</i>	141
<i>Error messages.....</i>	142
SCO UnixWare/SCO OpenServer 6	143
<i>Example of normal boot up messages for host cards.....</i>	143
<i>Error messages.....</i>	144
<i>I/O8+ host card error messages</i>	144
<i>I/O8+ software error messages</i>	145
Windows 2000/XP/Server 2003/Vista/Server 2008	146
<i>General troubleshooting under Windows 2000/XP/Server 2003/Vista/Server 2008.....</i>	147
<i>Windows 2000/XP/Server 2003/Vista/Server 2008 error messages.....</i>	148
 APPENDIX E CONTACTING PERLE	 149
<i>Making a technical Support Query</i>	<i>150</i>
<i>Who to contact.....</i>	150
<i>Information needed when making a query.....</i>	151
<i>Making a support query via the Perle web page.....</i>	152
<i>Repair procedure</i>	<i>153</i>
<i>Feedback about this manual</i>	<i>153</i>
<i>Contacting Perle technical support</i>	<i>154</i>
 INDEX	 155

Chapter 1 Introduction

You need to read this chapter if you want to...

You need to read this chapter if you want an introduction to the Perle I/O8+ serial adaptor cards, driver software and utilities.

This chapter provides introductory information about the Perle I/O8+ ISA and PCI serial adaptor cards, driver software and configuration utilities.

This chapter includes the following sections;

- [About the I/O8+ serial adaptor card](#) on page 16

About the I/O8+ serial adaptor card

The I/O8+ is a serial adaptor card which allows you to connect up to eight serial devices. This type of adaptor card is available in both ISA and PCI formats.

Each serial port has three device nodes associated with it. Each node takes the form of a **special file** which you can access in the normal manner from operating system utilities and user applications. See also [Appendix A Serial port device names](#) and your operating system manual for details of **special files**.

You use the I/O8+ when you want a robust entry level solution for the small office or point of sale applications. Typically you use I/O8+ because you want to add extra serial ports to an existing computer system rather than replacing it with the considerable cost that entails.

To use the I/O8+ serial adaptor cards you must first install the drivers supplied with the card for your operating system. You then configure each card as required prior to mechanical installation.

Note

The procedure for installing and configuring I/O8+ serial adaptor cards varies for different operating systems.

Please read [Before you start](#) on page 18 in [Chapter 2 Installing drivers and host cards](#) before commencing installation.

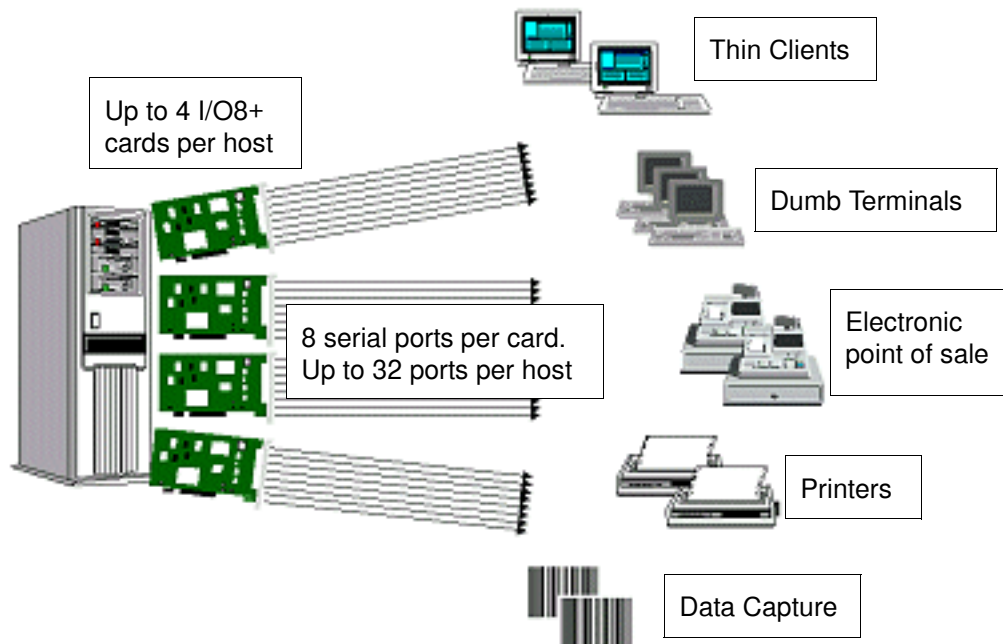

Chapter 2 Installing drivers and host cards

You need to read this chapter if you want to...

You need to read this chapter if you want to install I/O8+ serial adaptor cards and associated software.

This chapter provides information about installing and configuring I/O8+ serial adaptor cards in both ISA and PCI formats.

Note

The procedure for installing and configuring I/O8+ serial adaptor cards varies for different operating systems. Please read **Before you start** on page 18 before commencing installation.

This chapter includes the following sections;

- **Before you start** on page 18
- **Downloading I/O8+ drivers from the Perle web site** on page 18
- **Installing I/O8+ under Windows 95 and 98** on page 19
- **Installing under Windows NT** on page 33
- **Installing I/O8+ under SCO OpenServer** on page 34
- **Installing I/O8+ under SCO UnixWare** on page 57
- **Installing an I/O8+ PCI host card under Windows 2000/XP/Server 2003/Vista/Server 2008** on page 80
- **Installing an I/O8+ ISA host card under Windows 2000** on page 88
- **Installing a PCI host card** on page 100
- **Installing an ISA host card** on page 101
- **Removing host cards** on page 103.

Before you start

Before you install your I/O8+ host cards and software, note that the procedure for installing and configuring I/O8+ serial adaptor cards varies for different operating systems.

To install under a particular operating system, please refer to one of the operating system specific installation procedures listed below;

- [Installing I/O8+ under Windows 95 and 98](#) on page 19
- [Installing under Windows NT](#) on page 33
- [Installing I/O8+ under SCO OpenServer](#) on page 34
- [Installing I/O8+ under SCO UnixWare](#) on page 57
- [Installing an I/O8+ PCI host card under Windows 2000/XP/Server 2003/Vista/Server 2008](#) on page 80

Downloading I/O8+ drivers from the Perle web site

You can install the I/O8+ driver and utility software from the Perle web site. To do this proceed as follows;

1. On your PC, start the Internet browser you want to use (for example, Netscape).
2. Within your Internet browser window, select the software directory using the following URL;

<http://www.perle.com/downloads>

Note

In the event of any problems contact your System Administrator or Internet Service provider for assistance.

3. Change to the software directory.
The software directory is now displayed.
4. Download the zip files in this directory to a suitable location on your PC for example, /**tmp**.
5. Uncompress the files using a suitable utility.
6. You can now install the driver software using the correct procedure for your operating system. See [Before you start](#) on page 18.

Installing I/O8+ under Windows 95 and 98

This section tells you how to install I/O8+ host cards, software drivers and utilities under the Windows 95 and Windows 98 operating systems and includes the following;

- [General installation procedure for Windows 95 and 98](#) on page 19
- [Installing device drivers and utilities](#) on page 20
- [Adding ISA host cards to the system](#) on page 22
- [Configuring I/O8+ serial ports](#) on page 28
- [Removing I/O8+ hardware from your system](#) on page 31

General installation procedure for Windows 95 and 98

The general procedure for installing and configuring host cards, drivers software and associated utilities for the Windows 95 and 98 operating systems is as follows:

1. Download the I/O8+ driver files into your PC from the CDROM or the Perle website. See [Downloading I/O8+ drivers from the Perle web site](#) on page 18.
2. Install the I/O8+ Windows 95 and 98 drivers and utilities onto your system using the procedures described in [Installing device drivers and utilities](#) on page 20.
3. Select and assign addresses for any additional ISA host cards you want to install from the free addresses available. See [Adding ISA host cards to the system](#) on page 22.
4. Repeat step 3. until you have assigned addresses to all the ISA host cards you want to install.
5. Install any PCI host cards you require into your system. See [Installing a PCI host card](#) on page 100.
6. If required, remove any host cards you want from your system. See [Removing host cards](#) on page 103.
7. Re-start your system

Your system now detects any ports automatically, no configuration is required by the user. Your system can now use the serial adaptor cards you have installed. If required, you can reconfigure serial ports following initial installation. See [Configuring I/O8+ serial ports](#) on page 28.

Note

To remove the I/O8+ hardware from your system configuration, see [Removing I/O8+ hardware from your system](#) on page 31.

Installing device drivers and utilities

To install the I/O8+ device drivers and utilities for the Windows 95 or 98 operating systems proceed as follows;

1. Load the CDROM into your PC.

The web browser window is now displayed automatically showing a virtual website (the browser application depends on your system).

2. From the `\drivers\io8plus\win9x` directory, run the **setup.exe** file.

A welcome window is now displayed



3. In the Welcome window, click on the **Next >** button.

A progress message is displayed while installed devices are upgraded to use the new drivers, followed by the Setup Complete window as shown in the next pictures.



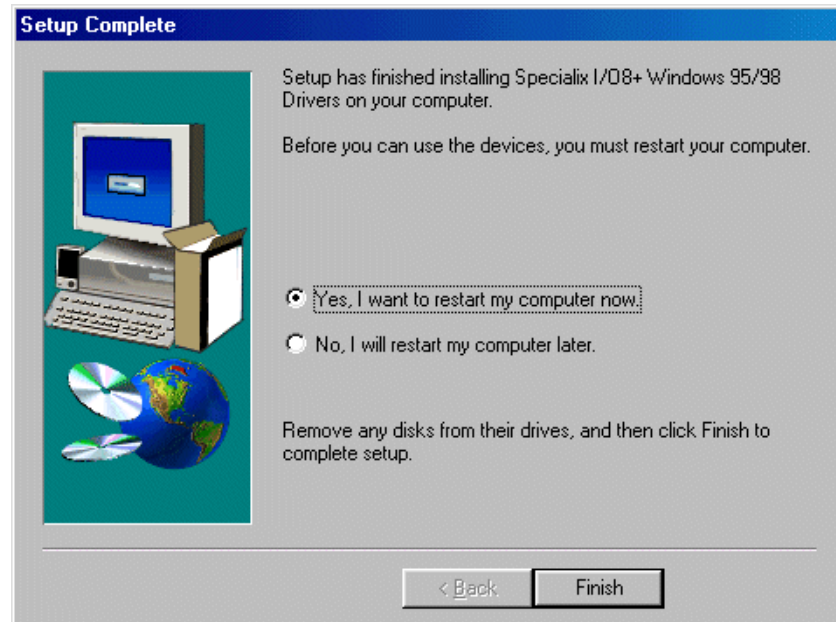

4. In the Setup Complete window click select the **Yes, I want to restart my computer now** option then click on **Finish** button to confirm your selection.

Hint

After the machine restarts, if windows cannot find a file whilst trying to install a Perle device a pop-up window is displayed asking you for the location of missing file. To remedy this;

- In the popup window, select the windows system directory for example, **c:\windows\system.**

Device installation should then be able to continue.

Installation of device drivers and utilities is now complete.

Adding ISA host cards to the system

To add an I/O8+ ISA host card to the system configuration, proceed as follows;

1. In the Windows desktop, click on the **Start** button and select **Settings > Control Panel** to display the Control panel window.
2. In the Control panel window, double click on the Add New Hardware icon.



The Add New Hardware Wizard is now displayed.

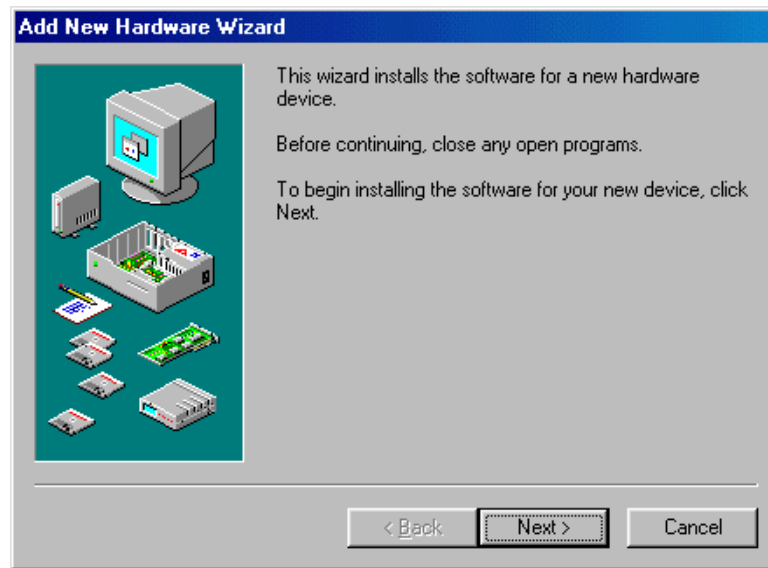

3. In the Add New Hardware Wizard click on the **Next >** button.
The page shown in the next picture is now displayed.



4. In the Add New Hardware Wizard, click on the **Next >** button.
The prompt page shown in the next picture is now displayed.



- In the prompt page, select the **No, I want the hardware from a list option** and then click on the **Next >** button to confirm your selection.

The hardware selection page is now displayed as shown in the next picture.



- In the hardware selection page, scroll down the **Hardware types** list and single click on the **Multi-function adapters** option to select it. Now click on the **Next >** button

The select manufacturer and model page is now displayed.

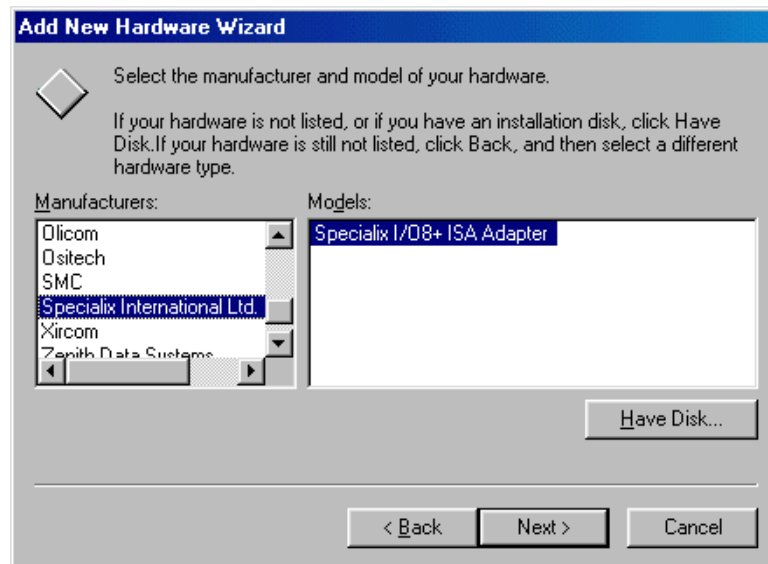

- In the select manufacturer and model page, scroll down the **Manufacturers** list and select **Specialix International Ltd.** Now scroll down the **Models** list and select the **Specialix I/O8+ ISA Adapter** option.

- In the select manufacturer and model page, click on the **Next >** button.

The system now tries to add the ISA card at its default address and IRQ level. **If the system can use the factory default address and IRQ settings** the following screen is now displayed.



Click on the **Details** button to display the factory defaults in use.

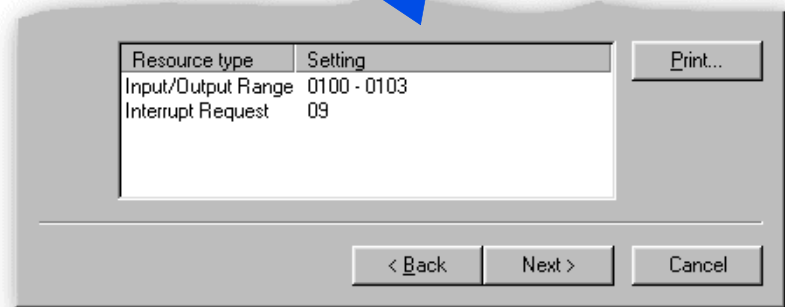

If the system has resources free but cannot use the factory defaults, the screen shown in the next picture is now displayed which shows values suggested by the system.

Note

If the system cannot use the factory default or allocate free resources you now need to try and resolve the resource conflict using the procedures given in [Resource conflicts](#) on page 132 in [Appendix D Troubleshooting](#).

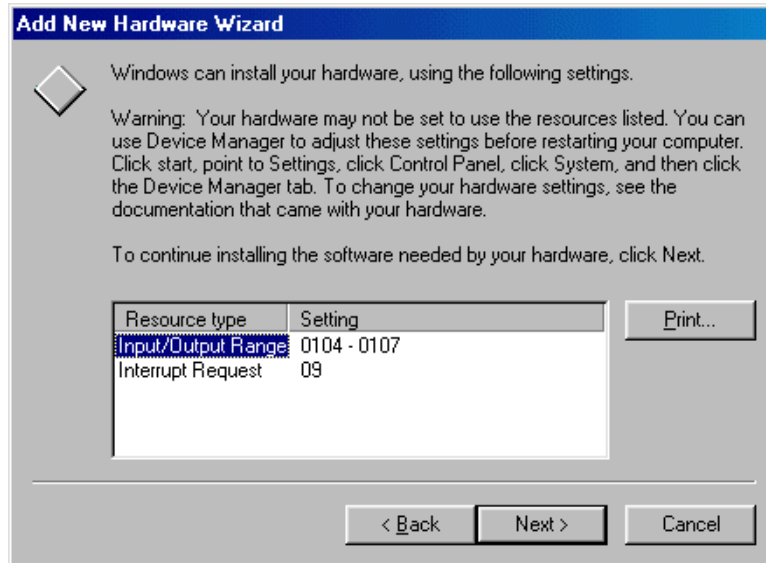

9. In the Add New Hardware Wizard, click on the **Next >** button.

The final page of the wizard is now displayed as shown in the next picture.



10. In the Add New Hardware Wizard, click on the **Finish** button to complete the setup.

The System Settings Change window is now displayed asking you if you are ready to shut down your computer and install the hardware.

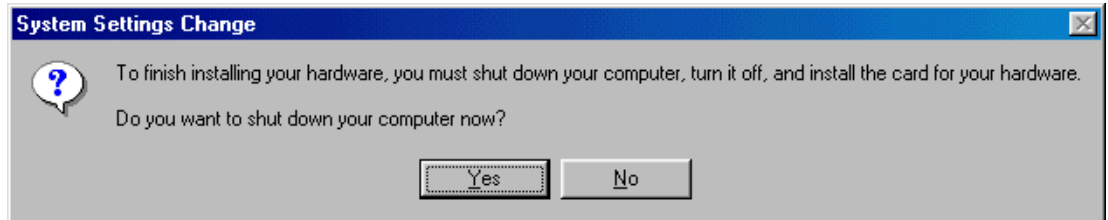

11. In the System Settings Change window, click on the **Yes** button to complete the installation.

You can now install your ISA host card. See [Installing an ISA host card](#) on page 101.

Configuring I/O8+ serial ports

Note

I/O8+ ports are normally configured as part of the installation process described in [Installing device drivers and utilities](#) on page 20. The procedures described in this section are provided for information only.

To configure I/O8+ serial ports proceed as follows;

1. In the Windows desktop, click on the **Start** button and select **Settings > Control panel**.
The control panel window is now displayed.

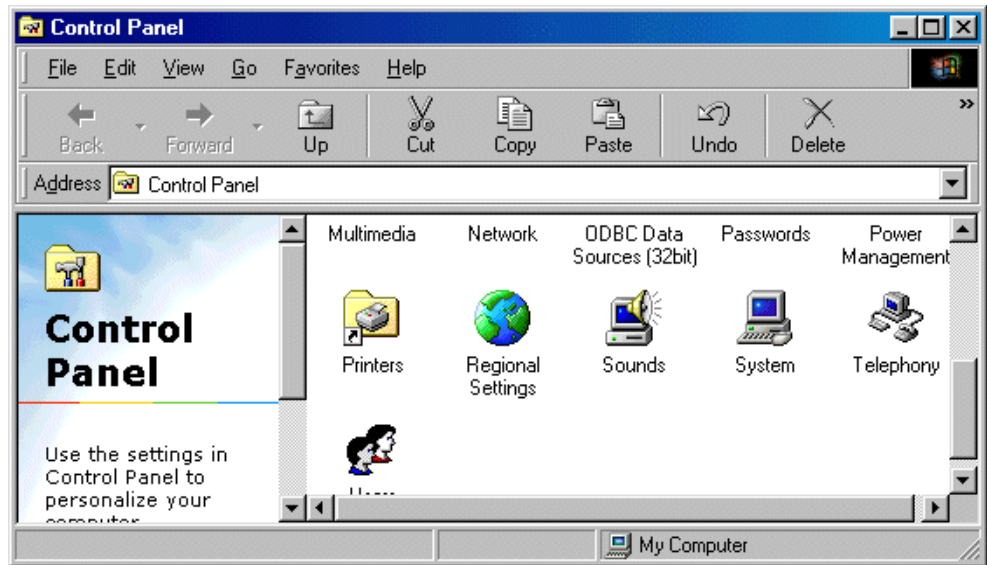

- In the control panel window, double click on the **System** icon.

The System Properties tabbed window is now displayed as shown in the next picture.

Hint

You can also display the **System Properties** tabbed window by right clicking on the **My Computer** icon on your desktop and selecting the **Properties** menu option.

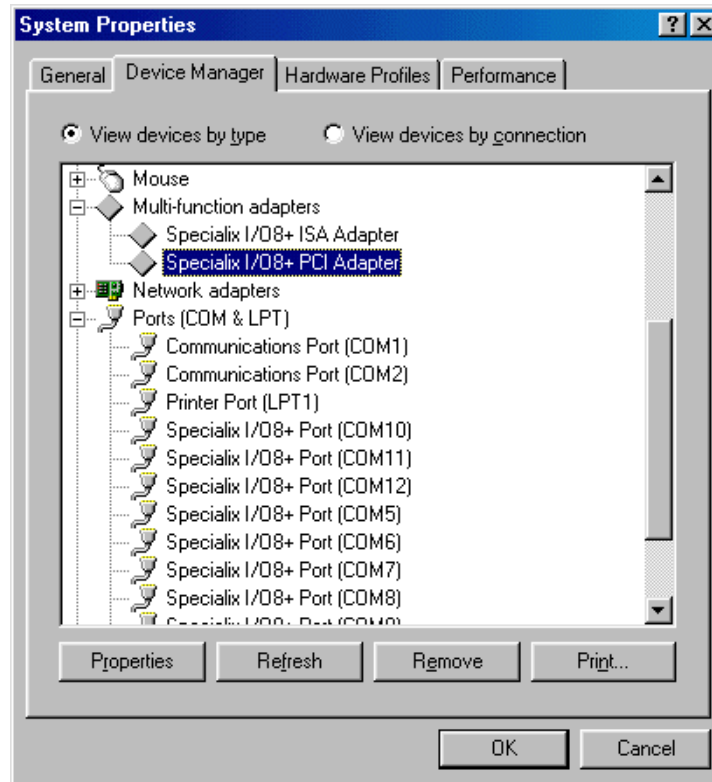

- In the System Properties tabbed window, click on the **Device Manager** tab.

The Device Manager page is now displayed.

- In the Device Manager page, double click on the device whose properties you wish to view.

The properties tabbed window for the selected device is now displayed.

5. In the properties window, click on the **Port Settings** tab.
The Settings page is now displayed.

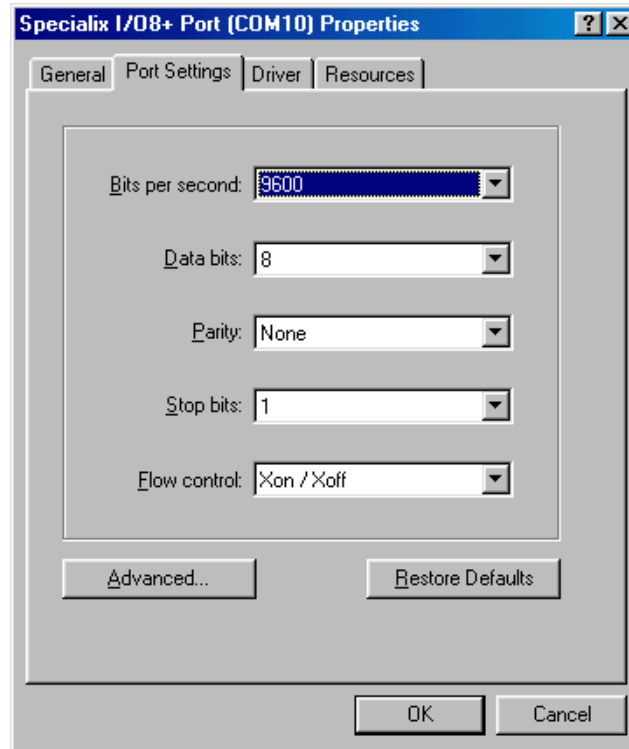

6. In the Settings page, select the configuration values you want and either click on the **OK** button.

Re-configuration of ports is now complete.

Removing I/O8+ hardware from your system

To remove I/O8+ hardware from your system configuration proceed as follows;

Note

This process does not remove the I/O8+ device drivers and utilities from your system.

1. In the windows desktop, click on the **Start** button and select **Settings > Control panel**.
The control panel window is now displayed.

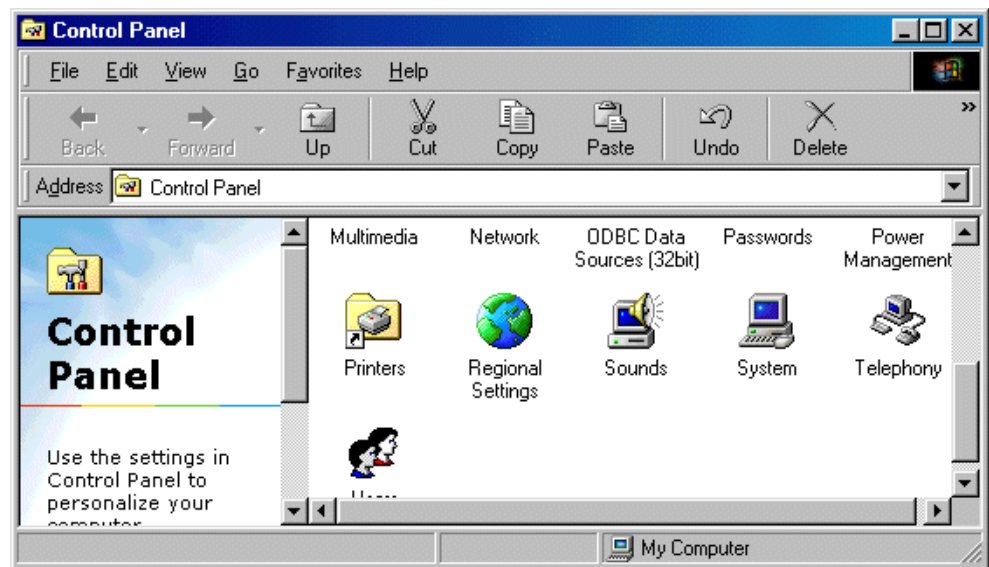

2. In the control panel window, double click on the **System** icon.
The System Properties tabbed window is now displayed as shown in the next picture.

- In the System Properties tabbed window, click on the **Device Manager** tab
The Device Manager page is now displayed as shown in the next picture.

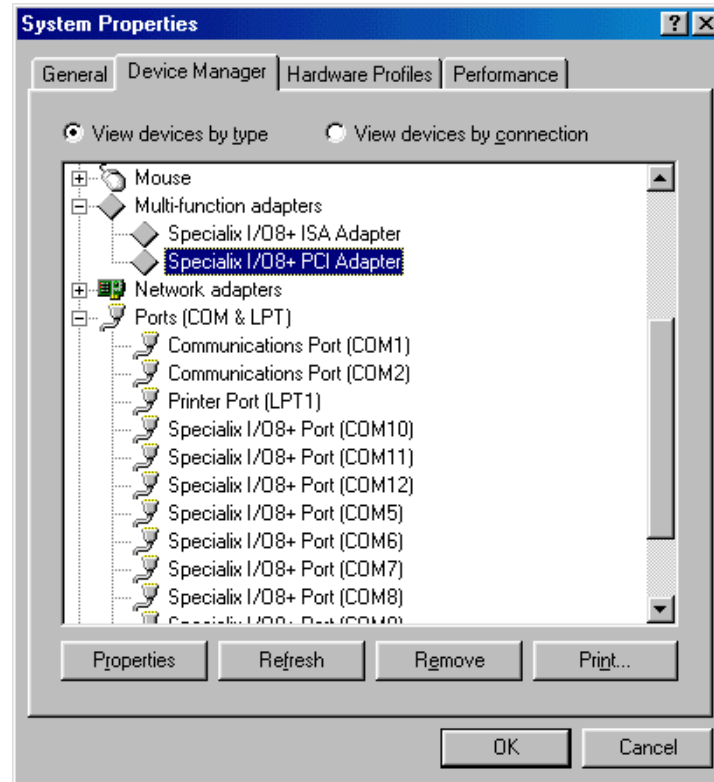

- In the Device Manager page, click on the **View devices by type** button.
The display is now updated to show installed devices by type.
- In the Device Manager page, click on the device you wish to remove, highlighting it then press the **Remove** button.

The selected device is now removed from the system.



Warning
If you remove the devices but do not remove the hardware, the devices will be re-installed when you next re-boot the machine or run the Hardware Wizard.

Installing under Windows NT

The procedure for installing and configuring host cards, drivers software and associated utilities for the Windows NT operating system is as follows:

Note

The Perle PortDirector software contains drivers for the I/O8+ host cards.

You will need to install the PortDirector **for Windows NT** on your system in order to use the I/O8+ host cards.

See [Chapter 5 Adding and deleting host cards](#) in the [PortDirector User guide](#) part number **5500028** for further details.

1. Install any PCI host cards you require into your system. See [Installing a PCI host card](#) on page [100](#)
2. Install any ISA host cards you require into your system. See [Installing an ISA host card](#) on page [101](#)
3. If required, remove any host cards you want from your system. See [Removing host cards](#) on page [103](#).
4. Use the PortDirector software to update your system with the revised number and type of host cards. See The PortDirector user guide part number 5500028 for further details.

Your system can now use the serial adaptor cards you have installed.

Installing I/O8+ under SCO OpenServer

This section tells you how to install host cards, software drivers and utilities under the SCO OpenServer operating system (SCO OpenServer 5 and SCO OpenServer 6) and includes the following;

- [General installation procedure for SCO OpenServer](#) on page [34](#)
- [Upgrading from existing device drivers](#) on page [36](#)
- [Installing device drivers and utilities](#) on page [37](#)
- [Assigning ISA host card addresses and IRQ levels \(SCO OpenServer 5 Only\)](#) on page [43](#)
- [Configuring I/O8+ serial ports](#) on page [51](#)
- [Removing I/O8+ drivers and utilities from your system](#) on page [55](#).

General installation procedure for SCO OpenServer

The general procedure for installing and configuring host cards, drivers software and associated utilities for the SCO OpenServer operating system is as follows:

1. If required, install any PCI host cards you require into your system. See [Installing a PCI host card](#) on page [100](#)

Note

SCO OpenServer 5 device drivers are displayed as Specialix I/O8+. SCO OpenServer 6 device drivers are displayed as Perle I/O8+.

Note

SCO OpenServer 6 supports only the PCI version of the I/O8+ card.

Note (SCO OpenServer 5 only)

If you are installing a PCI card after having installed your driver, you will need to run the io8hcfg utility to create the relevant device nodes. See [Assigning ISA host card addresses and IRQ levels \(SCO OpenServer 5 Only\)](#) on page [43](#) and [Appendix A Serial port device names](#).

Note

If your system has an EISA bus, you need to run the EISA configuration utility now. See your System Administrator or product user documentation for further details.

Note

If your system already has Specialix combined driver version 2.02 for SCO Unix 3.2.4 installed, you need to remove them before you can install new device drivers. See [Upgrading from existing device drivers](#) on page 36.

2. If required, install the I/O8+ SCO OpenServer drivers and utilities onto your system using the procedures described in [Installing device drivers and utilities](#) on page 37.
3. (SCO OpenServer 5 only) If required, using the **Host Card Configuration tool**, select and assign addresses for any additional ISA host cards you want to install from the free addresses available. See [Assigning ISA host card addresses and IRQ levels \(SCO OpenServer 5 Only\)](#) on page 43.
4. (SCO OpenServer 5 only) Repeat step 3. until you have assigned addresses to all the ISA host cards you want to install.
5. (SCO OpenServer 5 only) If required, install any ISA host cards you require into your system. See [Installing an ISA host card](#) on page 101.
6. If required, remove any host cards you want from your system. See [Removing host cards](#) on page 103.
7. Using the **Port Configuration tool**, configure the serial ports you have added to the system. See [Configuring I/O8+ serial ports](#) on page 51.

Your system can now use the serial adaptor cards you have installed. If required, you can reconfigure serial ports following initial installation. See [Assigning ISA host card addresses and IRQ levels \(SCO OpenServer 5 Only\)](#) on page 43 and [Configuring I/O8+ serial ports](#) on page 51 for details.

Upgrading from existing device drivers

If your system already has an existing Perle device driver installed, you cannot install a new device driver unless you follow the correct upgrade procedure. The procedure required depends on the device driver type currently installed as follows;

- [Upgrading from Specialix combined driver 2.0.2 for SCO Unix 3.2.4 \(SCO OpenServer 5 Only\)](#) on page 36

Note

SCO OpenServer 6 does not support the upgrade feature. If you are using SCO OpenServer 6, remove the existing driver using the procedure described in [Removing I/O8+ drivers and utilities from your system](#) on page 55. After the old device driver is removed, install the new device driver using the procedures described in [Installing device drivers and utilities](#) on page 37.

Upgrading from Specialix combined driver 2.0.2 for SCO Unix 3.2.4 (SCO OpenServer 5 Only)

You cannot upgrade the Specialix combined driver 2.0.2 for SCO Unix 3.2.4. You need to remove the old driver, then install its replacement as follows;

1. Remove the existing device driver using the procedure described in [Removing I/O8+ drivers and utilities from your system](#) on page 55.
2. Install the new device driver using the procedures described in [Installing device drivers and utilities](#) on page 37.
3. Continue with your installation as required using the steps listed under [General installation procedure for SCO OpenServer](#) on page 34.

Upgrading your current I/O8+ device driver (SCO OpenServer 5 Only)

To upgrade your current I/O8+ device driver, proceed as follows;

- Follow the procedure for installing device drivers detailed in [Installing device drivers and utilities](#) on page 37 using the upgrade options when prompted by the software.

Installing device drivers and utilities

To install the I/O8+ device drivers and utilities for the SCO OpenServer operating system proceed as follows;

1. Login to your system as super user.
2. Load the CDROM into your system CD drive.
3. At the command prompt, make a directory for your installation by typing:

```
mkdir /cdrom
```

4. Mount the CDROM file system using the following commands:

```
mount -f ISO9660 -r /dev/cd0 /cdrom
```

Note

The example above shows the directory name as **/cdrom**, You can either use this name or use another directory name to suit your requirements. For example, **/mnt**.

5. In the SCO OpenServer desktop, double click on the System Administration folder. The System Administration window is now displayed.
6. In the System Administration window, double click on the software manager icon. The Software Manager window is now displayed.

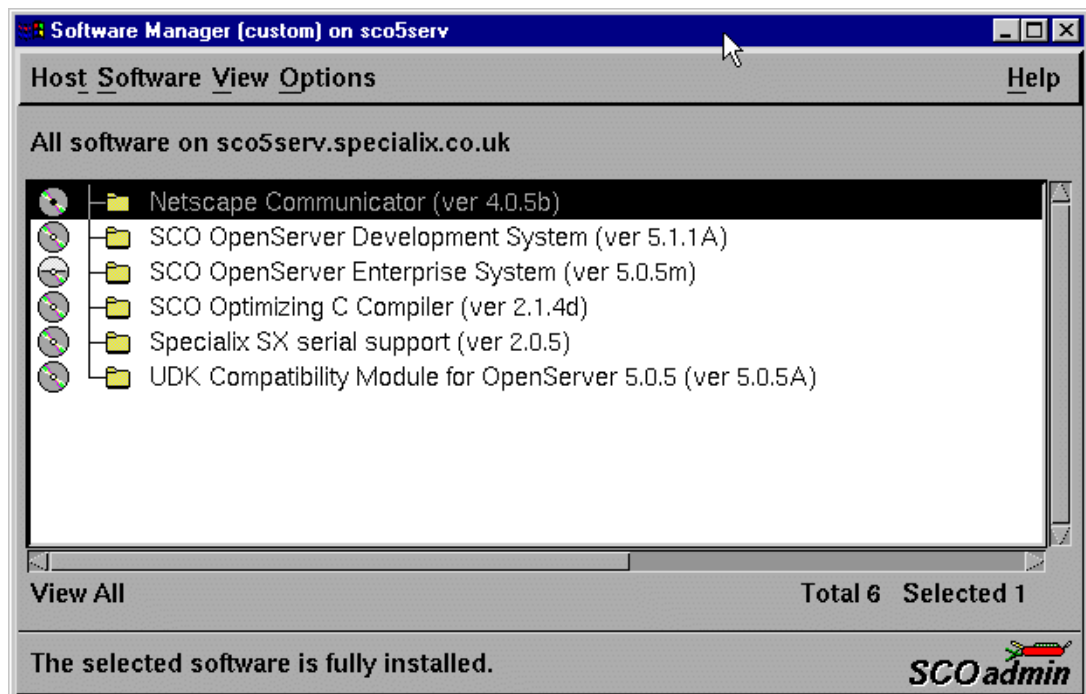

- In the Software Manager menu, click on **Software > Install New**.

The Begin Installation window is now displayed as shown in the next picture.

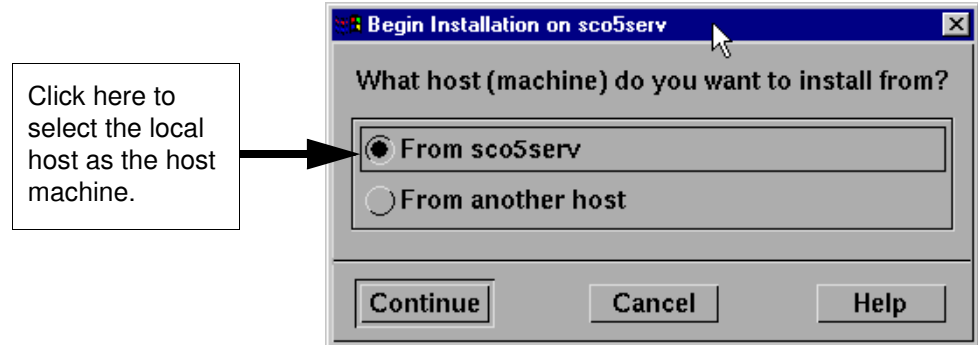

- In the Begin Installation window, select the local host as the machine to install from by clicking on the **From localhostname** button and then click on **Continue**.

The Select Media window is now displayed.



- In the Select Media window, using the **Media Device** selector choose the **Media Images** option then click on **Continue**.

The Enter Image Directory window is now displayed.

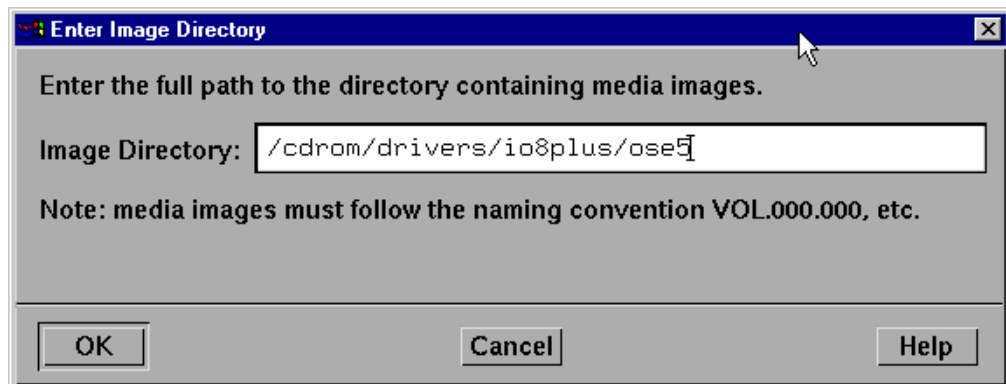

10. In the Enter Image Directory window, enter the following in the Image directory field;
SCO OpenServer 5: **/cdrom/drivers/io8plus/ose5**

SCO OpenServer 6: **/cdrom/drivers/io8plus/ose6**

Note

The example and picture above show a directory name including **/cdrom**, You can either include this name in the path or use another directory name to suit your requirements. For example, **/mnt**.

11. In the Enter Image Directory window, click on **OK**.

The Install Selection window is now displayed.

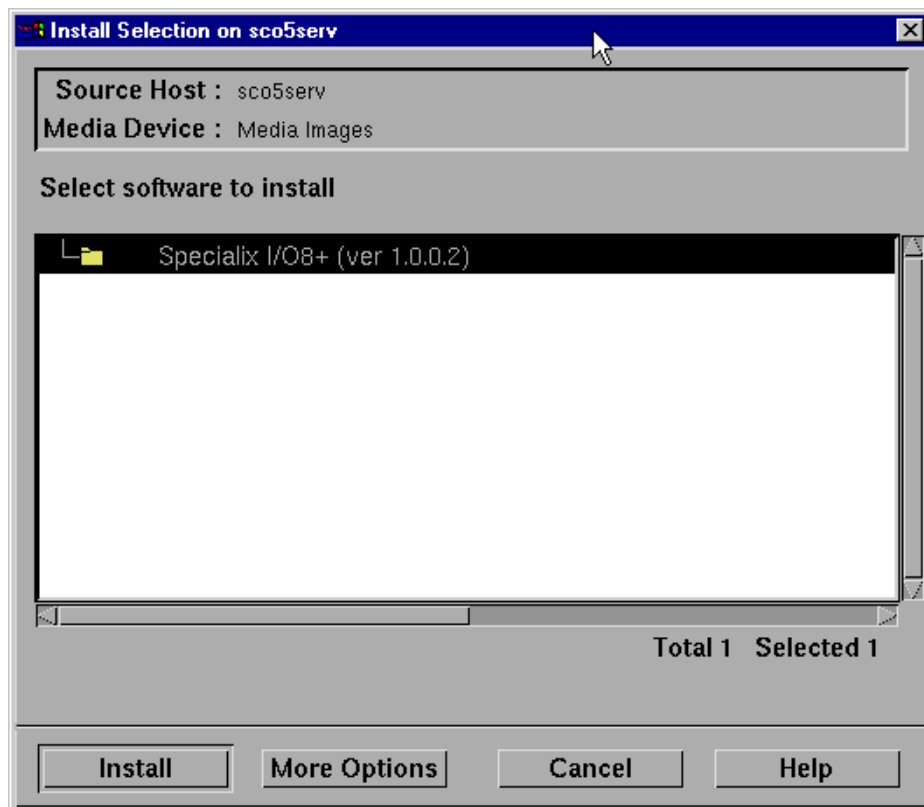

12. In the Install Selection window, click on the **Install** button.

If you are upgrading your current Perle I/O8+ SCO OpenServer 5 device driver, the following pop-up window is now displayed.

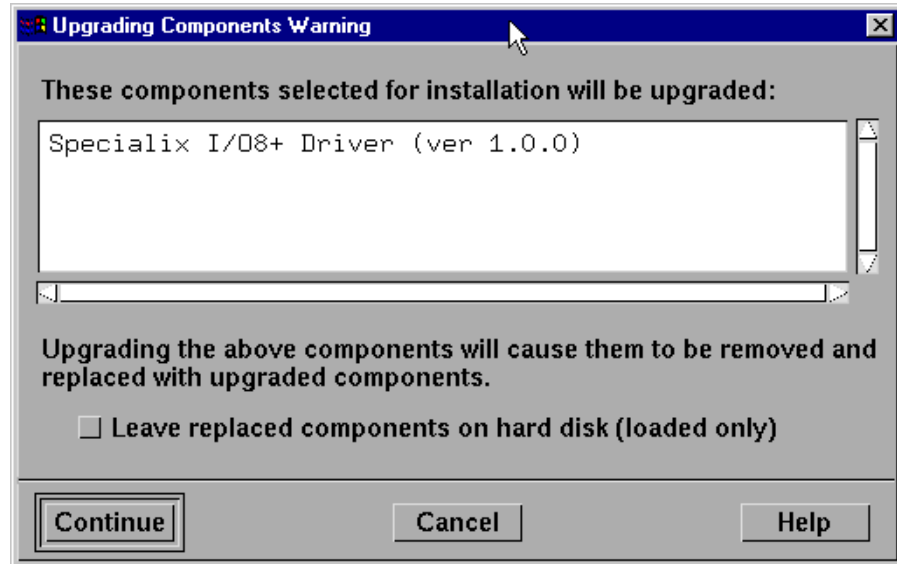

13. In the pop-up window, click on the **Continue** button to continue the installation process.

The following progress message is now displayed.

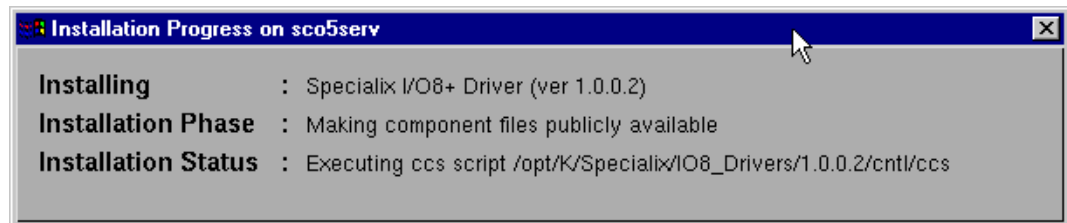

The Specialix I/O8+ Installation Options window is now displayed.

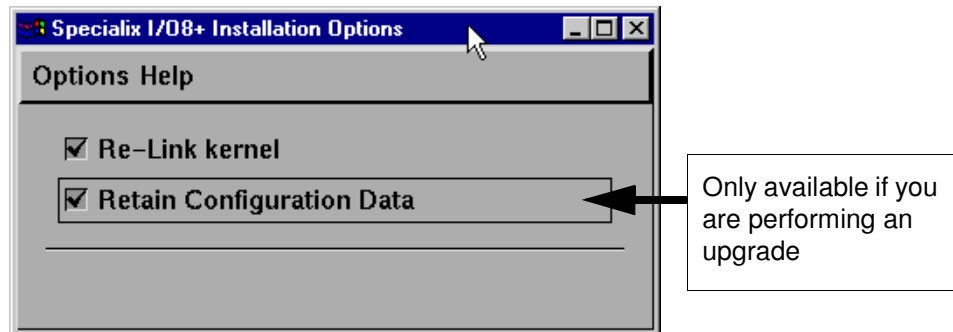

14. If required, in the Specialix I/O8+ Installation Options window, select the **Re-Link kernel** option. (SCO OpenServer 6 users skip to step **18.**)

Hint

If you are installing more than one driver, you can de-select this option until you have installed all the drivers and utilities you require to save time.

15. If you wish to retain the existing configuration from a previous device driver installation, in the Specialix I/O8+ Installation Options window, select **Retain Configuration Data**.
16. In the Specialix I/O8+ Window Installation menu, click on **Options > Exit** to close the window and continue the installation process.

The host card configuration window is now displayed.

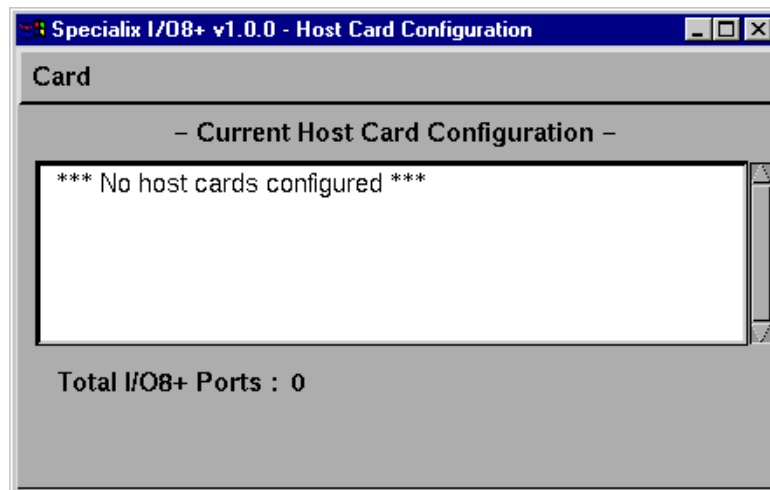

17. Using the Host Card Configuration utility, add any cards you want to the system then exit the utility using the **Card > Save and exit** menu option. See [Assigning ISA host card addresses and IRQ levels \(SCO OpenServer 5 Only\)](#) on page 43.

If you have re-linked the kernel earlier in this procedure, a message window is now displayed prompting you to re-boot the system.

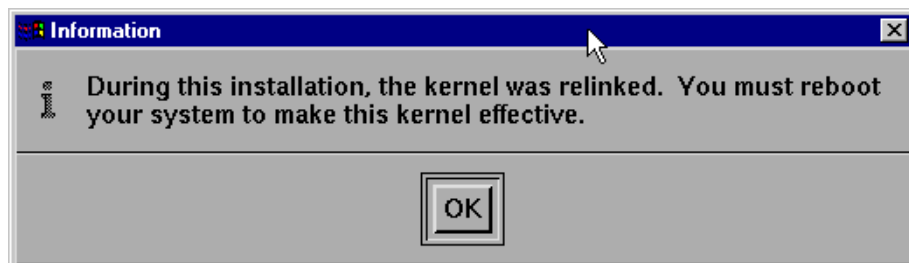

18. In the message window click on **OK** to continue the installation process.

The following message is now displayed upon completion of the installation process.

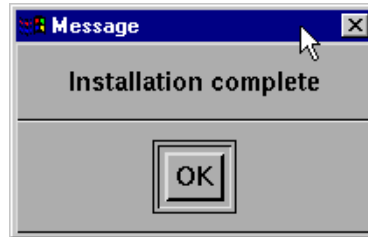

19. In the message window, click on **OK** to close the window.

The software manager window is now updated to show the driver you have installed as shown in the next picture.

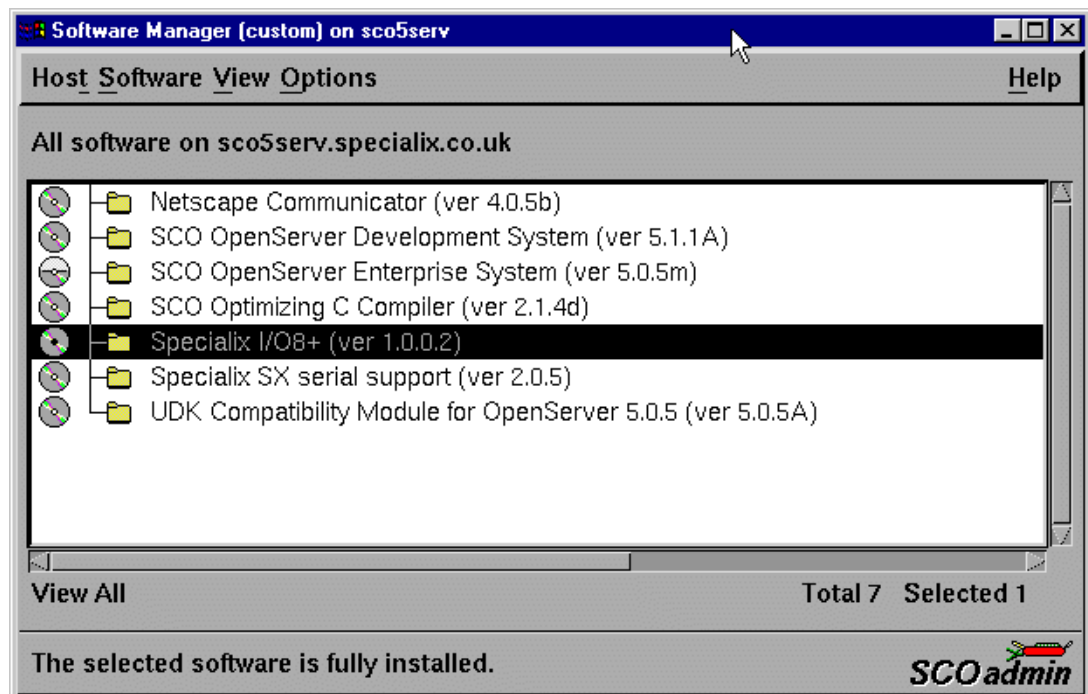

20. In the Software Manager window, click on the **Host > Exit** menu option to close the window.

21. Shut down your system and turn the power off. You can now continue with the rest of the installation process see [General installation procedure for SCO OpenServer](#) on page [34](#).

Assigning ISA host card addresses and IRQ levels (SCO OpenServer 5 Only)

The Host Card Configuration Utility allows you to define and edit addresses and IRQ levels for I/O8+ host cards you add to the system. In addition this utility automatically creates and removes serial port device nodes.

This section includes the following;

- [Starting the Host Card Configuration utility](#) on page [44](#)
- [Adding a new host card address](#) on page [45](#)
- [Editing a host card address](#) on page [47](#)
- [Removing a host card address](#) on page [49](#)
- [Exiting the Host Card Configuration utility](#) on page [50](#)

Note

If you make any changes to the host card addresses on the system, you will need to restart the software kernel. See [Re-building the kernel](#) on page [50](#) for details.

Starting the Host Card Configuration utility

You can start the Host Card Configuration utility in one of two ways;

- Using the command line. See [page 44](#).
- Using the SCO OpenServer 5 desktop. See [page 44](#).

Using the command line

To start the Host Card Configuration Utility from the command line proceed as follows;

1. At the command prompt, type **io8hcfg** and press the **Enter** key.

The Host Card Configuration window is now displayed.

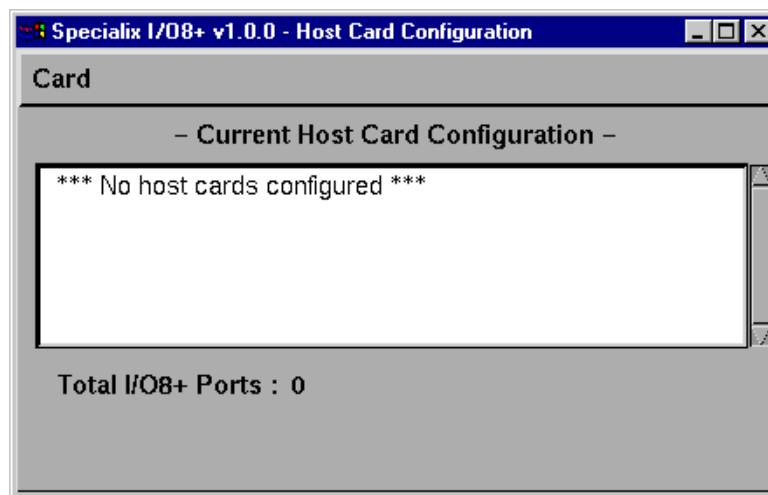

You can now use the utility to add, remove or edit host card parameters.

Using the SCO OpenServer 5 desktop

To start the Host Card Configuration Utility from the SCO OpenServer 5 desktop proceed as follows;

1. In the SCO OpenServer 5 desktop, open the **System Administration** folder.
The System Administration window is now displayed.
2. In the System Administration window, click on the **Specialix I/O8+** folder to open it.
The Specialix I/O8+ window is now displayed

3. In the Specialix I/O8+ window, click on the **I/O8+ Host Configuration** icon.
The Host Card Configuration window is now displayed.

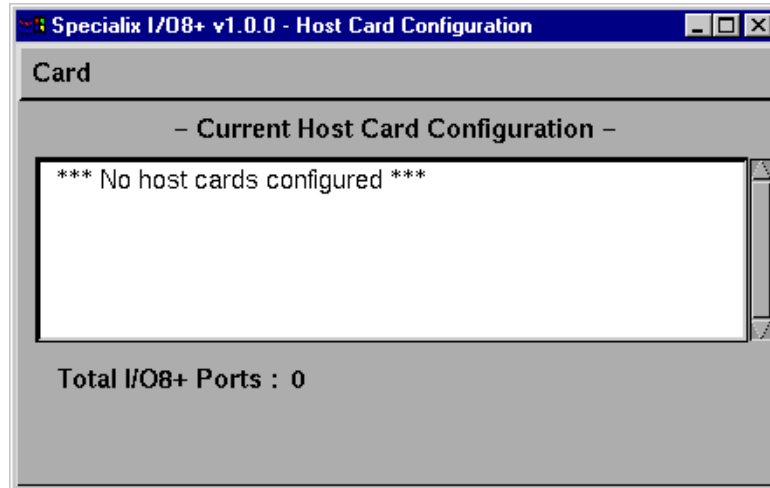

You can now use the utility to add, remove or edit host card parameters.

Adding a new host card address

In order to function, each ISA host card must be allocated an available I/O address and IRQ level. The Host Card Configuration utility allows you to determine the available addresses and IRQ levels, then allocate them to a particular host card. To do this, proceed as follows;

1. In the Host Card Configuration menu, click on **Card > Add**.

The Set Address and IRQ window is now displayed which shows the next available host card address and IRQ level by default.

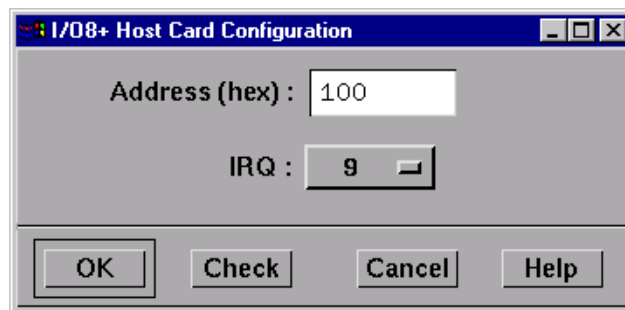

Selecting non-default address and IRQ level

2. If you want to allocate an address and IRQ level other than the default proceed as follows;
 - a. In the Set Address and IRQ window, click in the **Address (hex)** field and enter the address you want in hexadecimal.
 - b. In the Set Address and IRQ window, click on the **IRQ** (Interrupt level ReQuest level) selector and select a free IRQ level.

Testing your selection

3. In the Set Address and IRQ window, click on the **Check** button to verify the values you have entered.

The Resource Check Result pop-up is now displayed telling you whether or not the selected address and IRQ level are valid. An example is shown in the next picture.

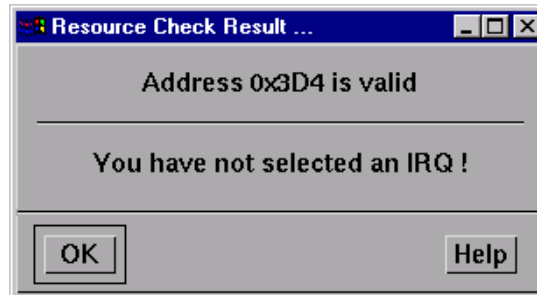

4. In the pop-up, click on **OK** to close the window.
5. In the Host Card Configuration window click on **OK** to confirm your selection and close the window.

If your selection is invalid, the Resource Check Result pop-up message is now displayed. Otherwise, the address is now set and the host card configuration window updated to show the new card and address.

Editing a host card address

To edit an existing host card address on the system proceed as follows;

1. In the host card Configuration window, select the host card whose address you want to edit.

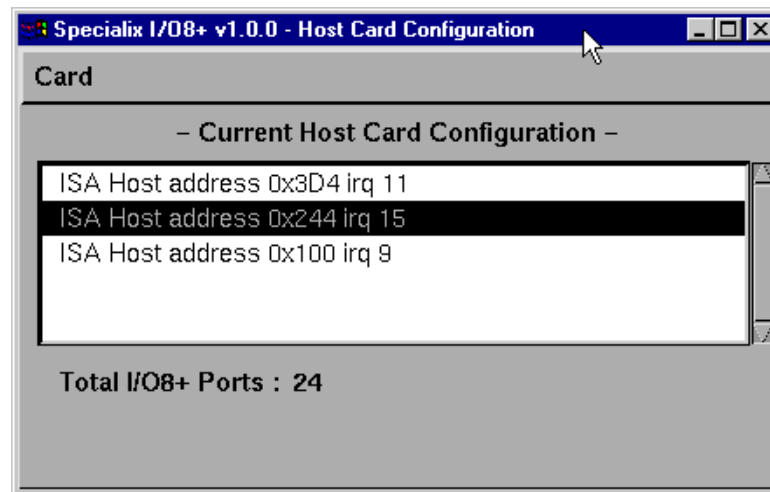

2. In the Host Card Configuration menu, click on **Card > Edit**.

The Set Address and IRQ window is now displayed showing the current address and IRQ level for the selected host card.

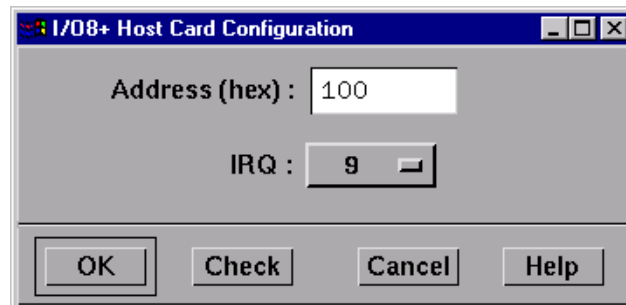

3. In the Set Address and IRQ window click in the **Address (hex)** field and enter the address you want in hexadecimal.
4. In the Set Address and IRQ window, click on the **IRQ** (Interrupt level ReQuest level) selector and choose the IRQ level you want.

Testing your selection

5. If required, in the Set Address and IRQ window, click on the **Check** button.

The Resource Check result pop-up is now displayed telling you if the selected address and IRQ level are valid. An example is shown in the next picture.

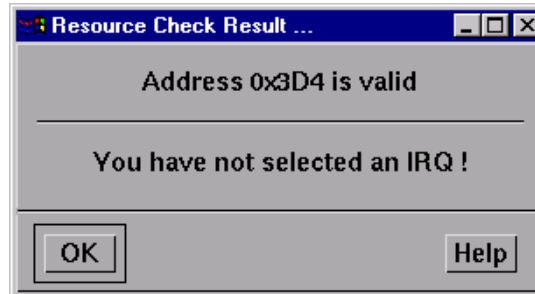

6. In the pop-up, click on **OK** to close the window
7. In the Host Card Configuration window, click on **OK** to confirm any changes and close the window.

If your selection is invalid, the Resource Check Result pop-up message is now displayed. Otherwise, the new address is now set and the host card configuration window updated to show the changes.

Removing a host card address

To remove a host card address from the system, proceed as follows;

1. In the host card configuration window, click on one or more of the host cards listed in the Current Host Card Configuration field highlighting them.

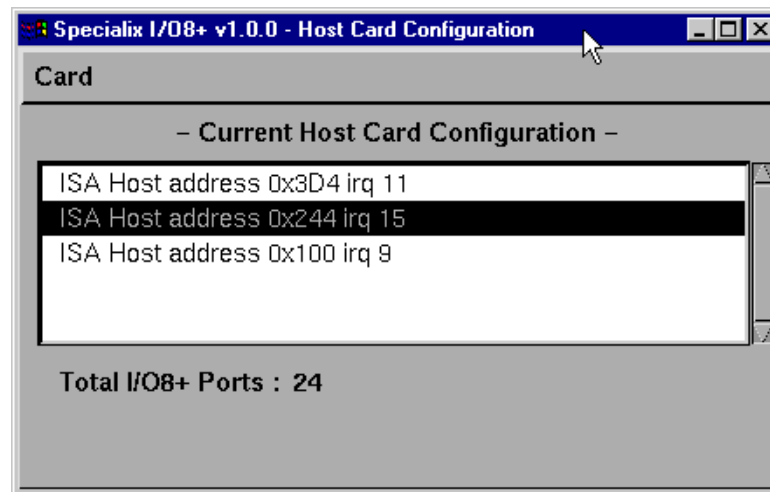

2. In the Host Card Configuration menu, click on **Card > Remove**.

The Host Card Configuration window is now updated to show the remaining host cards only.

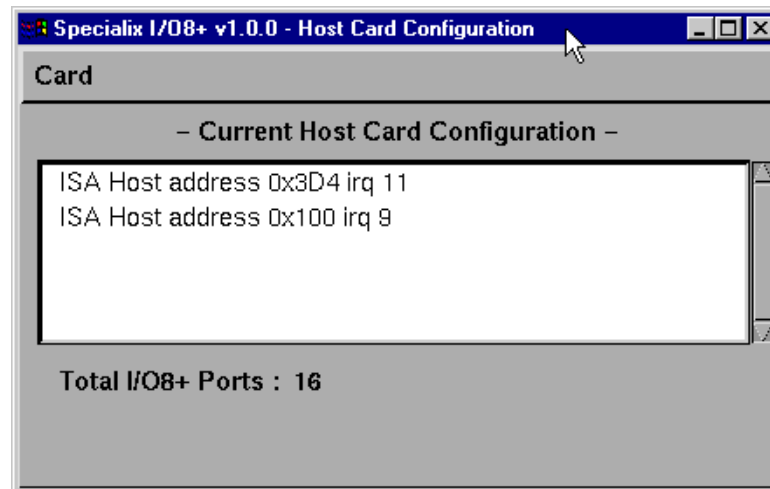

Exiting the Host Card Configuration utility

Quitting and saving To exit the Host Card Configuration utility and save any changes you have made, proceed as follows;

1. In the Host Card Configuration menu, click on **Card > Save and exit**.

Re-building the kernel

If you have made any changes a pop-up now appears prompting you to re-build the operating system kernel, otherwise the utility closes.

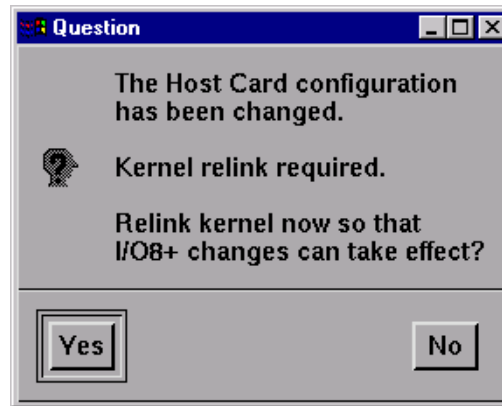

2. In the pop-up, click on the **Yes** button to re-link the operating system kernel.

The Kernel now re-links and a busy message is displayed during this process, followed by a confirmation pop-up.

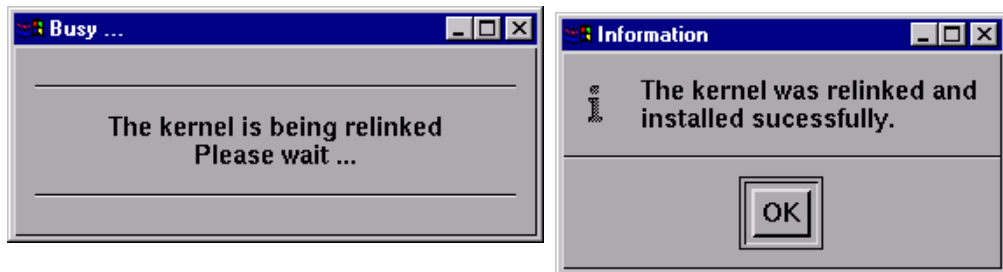

3. In the confirmation pop-up, click on OK to close the window.

The Host Card Configuration utility now closes and saves any changes you have made.

Note

To quit the Host Card Configuration utility without saving any changes:

- In the In the Host Card Configuration menu, click on **Card > Quit**.

Configuring I/O8+ serial ports

The Port Configuration utility allows you to configure the extra I/O8+ serial ports you have added to your system. To do this proceed as follows;

Note

If you want to perform transparent printing from any of the terminals attached to your system, you need to check the contents of the **printcap.io8** file to see if the terminal type you are using is supported. To do this proceed as follows;

1. Using a text editor, go to the **/etc** directory and open the file called **printcap.io8**
2. Check the contents of the **printcap.io8** file to see if the terminal type you are using is supported. See [page 124](#) in [Appendix B Transparent printing](#) for the syntax of the entries in this file.
3. If the terminal type you are using is not supported, add an entry for the new terminal type (including the type, transparent print ON and transparent print OFF strings) to the **printcap.io8** file ([page 124](#)). See the user guide for your terminal for details of the entries required.

You can now configure the ports you want using the Port Configuration utility.

Starting the Port Configuration utility

1. In the command prompt, type **io8pcfg** and press the **Enter** key.

Or use the SCO OpenServer 5 desktop as follows;

- a. In the SCO OpenServer 5 desktop, open the **System Administration** folder. The System Administration window is now displayed.
- b. In the System Administration window, click on the **Specialix I/O8+** folder to open it. The Specialix I/O8+ window is now displayed
- c. In the Specialix I/O8+ window, click on the **I/O8+ Port Configuration** Icon.

Or use the SCO OpenServer 6 desktop as follows;

- a. In the SCO OpenServer 6 desktop, open the **System Administration** folder. The System Administration window is now displayed.
- b. In the System Administration window, click on the **Perle-Serial** folder to open it. The Perle-Serial window is now displayed
- c. In the Perle-Serial window, click on the **I/O8+ Port Configuration** Icon.

The Port Configuration window for SCO OpenServer 5 is shown in the next picture (SCO OpenServer 6 would have the Perle I/O8+ Port Configuration window title).

Menus see [page 115](#).

Select one or more ports from this list.

Port	Login	gettydef	Terminal Type	Forced flow control
1		m	unknown	
2		m	unknown	
3		m	unknown	
4		m	unknown	
5		m	unknown	
6		m	unknown	
7		m	unknown	
8		m	unknown	

Select a getty definition here. See [page 53](#).

Available gettydefs: k, l, m, n

Terminal type: tvi925, unknown, vt220, wspc65

Select a terminal type here. See [page 53](#)

Transparent print flow control: ixon ixany

Enables or disables flow control. See [page 53](#)

Enables or disables login. See [page 54](#)

Login Session:

Selecting ports

- In the Port Configuration window, select the ports you want you want to configure by clicking on one or more items in the list of ports (example in next picture).

Hint

To select multiple items which follow each other in the list, hold down the **Shift** key and click on all the items you want.

To select multiple items from anywhere in the list, hold down the **Ctrl** key and click on all the items you want.

Port	Login	gettydef	Terminal Type	Forced flow control
1		m	unknown	
2		m	unknown	
3		m	unknown	

Selecting a getty definition

3. In the Port Configuration window, select the getty definition you want by double clicking on an item in the **Available gettydefs** list. Alternatively, click on the **Set** button.

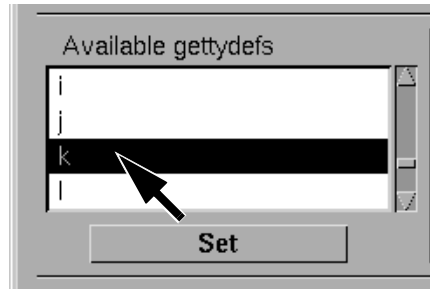

The list of currently selected ports is now updated to show the new getty definition.

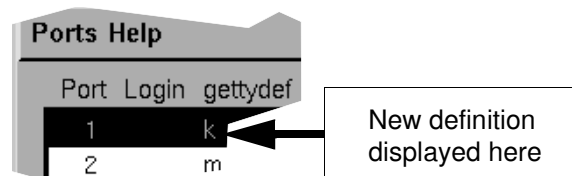

Selecting terminal type

4. In the Terminal type list, double click on the terminal type you want for the currently selected ports. Alternatively, single click on the item you want in the Terminal type list and press the **Set** button.

The list of ports is now updated to show the new terminal type

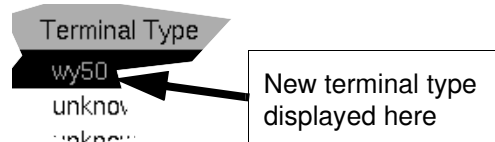

Enabling and disabling flow control

5. If required, in the Port Configuration window, click on the **ixon** button to enable flow control for Transparent printing.

Note
For information about transparent printing, see [Appendix B Transparent printing](#).

6. If required, in the Port Configuration window, click on the **ixany** button to enable sending of data on receipt of the next character (when flow control is enabled on the transparent print port).

Setting up a port login

- In the Port Configuration window, click on one of the menu options shown in the next table to display the ports with the login status you want to change. For example, ports without logins enabled.

These options allow you to filter on the type of ports you are looking for. This facility is helpful when you have a large number of ports installed.

To Display	Click menu option
All ports with logins enabled	Ports > Logins
All ports without logins enabled	Ports > Unconfigured
Display all ports	Ports > All

- If required, in the Port Configuration window, select the ports whose logins status you want to change, then click on one of the following to change the login status;

Tc	Click on ..
Enable logins for a port	Enable button
Disable logins for a port	Disable button

The selected ports in the list now are updated show their new login status. For example if you enable the login for a port, a tick is displayed along side the port as shown in the next picture.

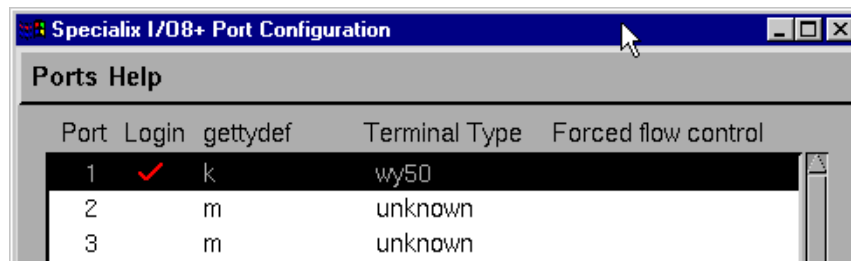

- Repeat steps 2. to 8. until you have configured all the ports you want.

Exiting the Port Configuration tool

- In the Port Configuration menu, click on **Ports > Save & Exit**.

Note

To quit the Port Configuration tool without saving changes,

- In the Port Configuration menu, click on **Ports > Quit**.

The Port Configuration tool now closes and saves any changes you have made.

Removing I/O8+ drivers and utilities from your system

To remove the I/O8+ device drivers and utilities for the SCO OpenServer operating system proceed as follows;

1. In the SCO OpenServer desktop, double click on the System Administration folder.
The System Administration window is now displayed.
2. In the System Administration window, double click on the software manager icon.
The Software Manager window is now displayed.

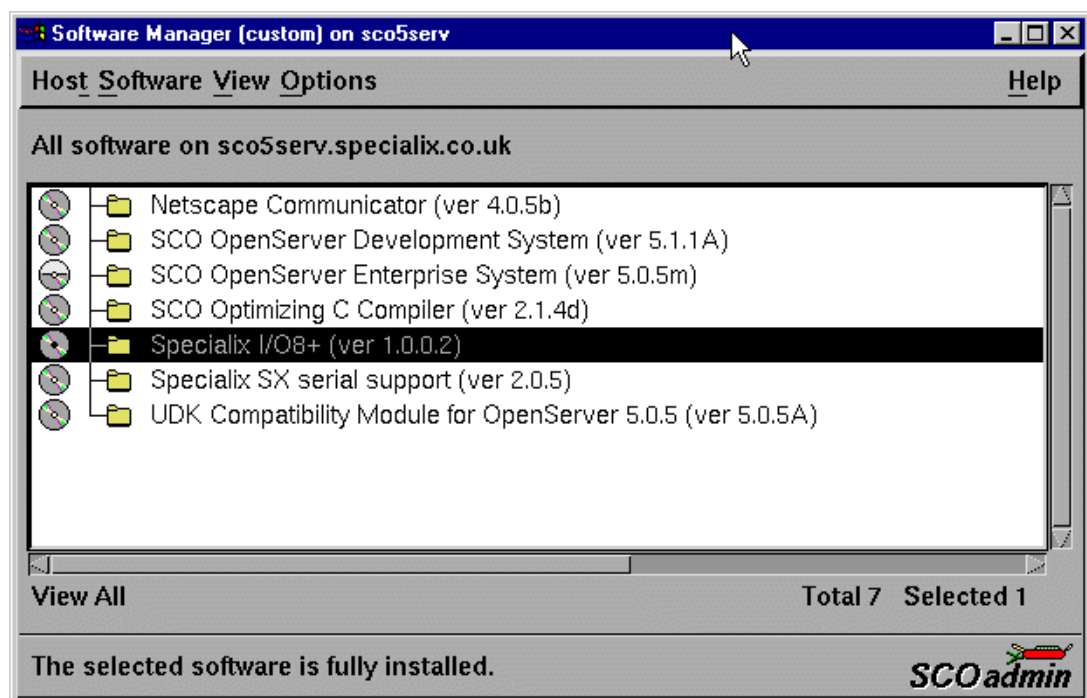

Note

SCO OpenServer 5 device drivers are displayed as Specialix I/O8+. SCO OpenServer 6 device drivers are displayed as Perle I/O8+.

3. In the Software Manager window select the driver you want to remove.
4. In the Software Manager menu, click on **Software > Remove software**.
A confirmation window is now displayed prompting you to confirm removal

5. In the confirmation window, click on the **Remove** button.

The software is now removed and the following Kernel re-link message is now displayed as shown in the next picture.



The Kernel re-link message window now closes and the removal continues. A message is displayed upon completion.

6. In the message window, click on **OK** to close the window.

The software manager window is now updated to show the remaining software.

Installing I/O8+ under SCO UnixWare

This section tells you how to install host cards, software drivers and utilities under the SCO UnixWare operating system and includes the following;

- [General installation procedure for SCO UnixWare](#) on page **58**
- [Upgrading from existing device drivers](#) on page **60**
- [Installing drivers and utilities onto your system](#) on page **61**
- [Assigning ISA host card addresses and IRQ levels](#) on page **64**
- [Configuring serial ports](#) on page **73**
- [Configuring serial ports under SCO UnixWare 2](#) on page **78**
- [Removing I/O8+ drivers and utilities from your system](#) on page **79**.

General installation procedure for SCO UnixWare

The general procedure for installing and configuring host cards, drivers software and associated utilities for the SCO UnixWare operating system is as follows:

1. Install any PCI host cards you require into your system. See [Installing a PCI host card](#) on page [100](#)

Note

Once you have installed the I/O8+ drivers, if you add or remove any host cards the operating system will update the kernel accordingly using the **spxnodescrt** script.

The **spxnodescrt** script is run automatically during boot up and checks to see if any host cards have been added or removed since the last time the system was powered up. If anything has changed the **spxnodescrt** script recreates the files which identify the ports, terminals and transparent printing and applies the changes.

Note

If your system already has Specialix IO8 Svr4 driver v1.0.2 for SVR4 operating systems, you need to remove them before you can install new device drivers. See [Upgrading from existing device drivers](#) on page [60](#).

2. If required, install the I/O8+ SCO UnixWare drivers and utilities onto your system using the procedures described in [Installing drivers and utilities onto your system](#) on page [61](#).
3. If required, using the **UnixWare Device Configuration Utility**, select and assign addresses for any additional ISA host cards you want to install from the free addresses available. See [Assigning ISA host card addresses and IRQ levels](#) on page [64](#).
4. Repeat step [3](#). until you have assigned addresses to all the ISA host cards you want to install.
5. If required, install any ISA host cards you require into your system. See [Installing an ISA host card](#) on page [101](#)
6. If required, remove any host cards you want from your system. See [Removing host cards](#) on page [103](#).
7. Using the **Serial Manager** utility, configure the serial ports you have added to the system. See [Configuring serial ports](#) on page [73](#).

Note

If you are running version 2 of the SCO UnixWare operating system you need to use the procedures described in [Configuring serial ports under SCO UnixWare 2](#) on page [78](#) to configure your serial ports.

Your system can now use the serial adaptor cards you have installed. If required, you can reconfigure serial ports following initial installation. See [Assigning ISA host card](#)

[addresses and IRQ levels](#) on page 64 and [Configuring serial ports](#) on page 73 for details.

Upgrading from existing device drivers

If your system already has an existing Perle device driver installed, you cannot install a new device driver unless you follow the correct upgrade procedure. The procedure required depends on the device driver type currently installed as follows;

- [Upgrading from Specialix I/O8+ Svr4 driver v1.0.2](#) on page [60](#)

Upgrading from Specialix I/O8+ Svr4 driver v1.0.2

You cannot upgrade the Specialix I/O8+ Svr4 driver v1.0.2. You need to remove the old driver, then install its replacement as follows;

1. Remove the existing device driver using the procedure described in [Removing I/O8+ drivers and utilities from your system](#) on page [79](#).
2. Install the new device driver using the procedures described in [Installing drivers and utilities onto your system](#) on page [61](#).
3. Continue with your installation as required using the steps listed under [General installation procedure for SCO UnixWare](#) on page [58](#).

Installing drivers and utilities onto your system

To install the I/O8+ device drivers and utilities for the SCO UnixWare operating system proceed as follows;

1. Login to your system as super user.
2. Load the CDROM into your system CD drive.
3. At the command prompt, type **scoadmin**.

The System Administration window is now displayed.

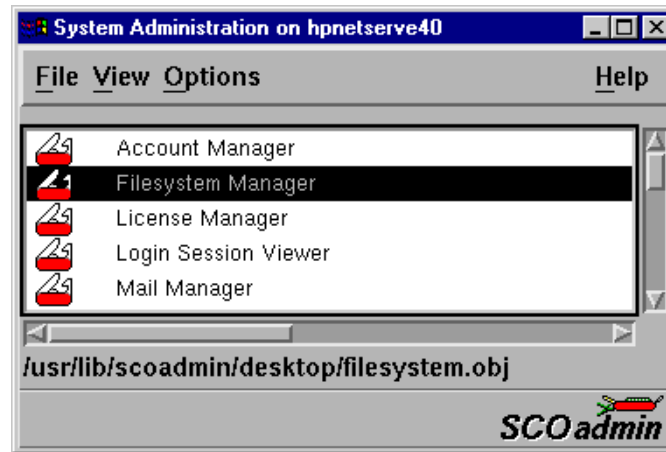

4. In the System Administration window, double click on the **Filesystem Manager** folder.

The Filesystem Manager window is now displayed.

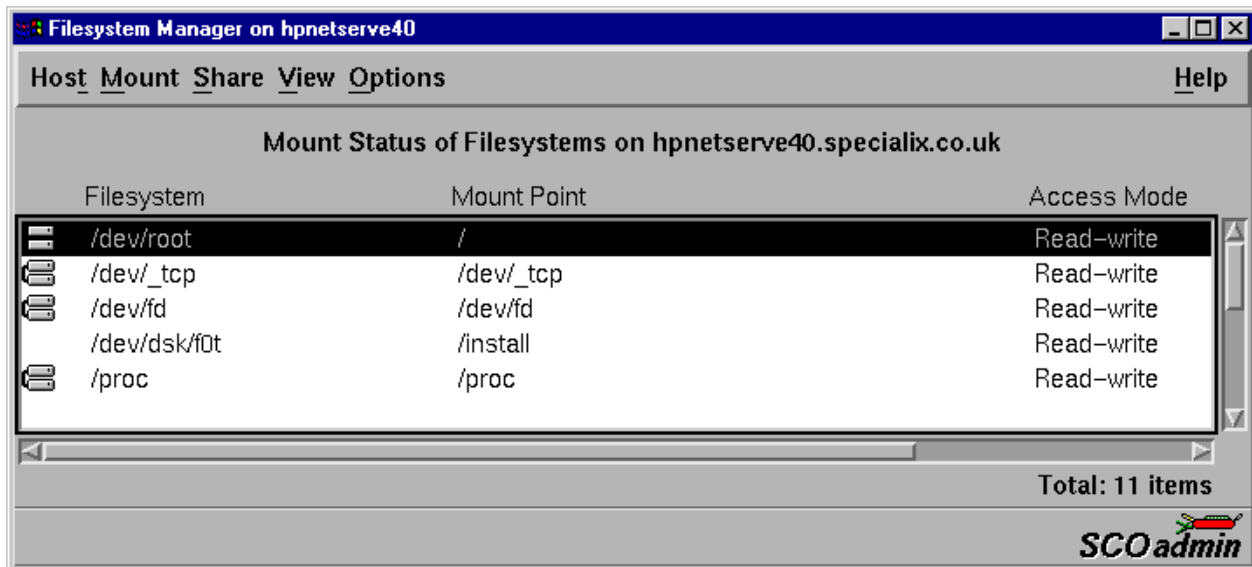

- In the Filesystem Manager menu, click on **Mount > Add Mount Configuration >Local**.
The Add Local Mount Configuration window is now displayed.

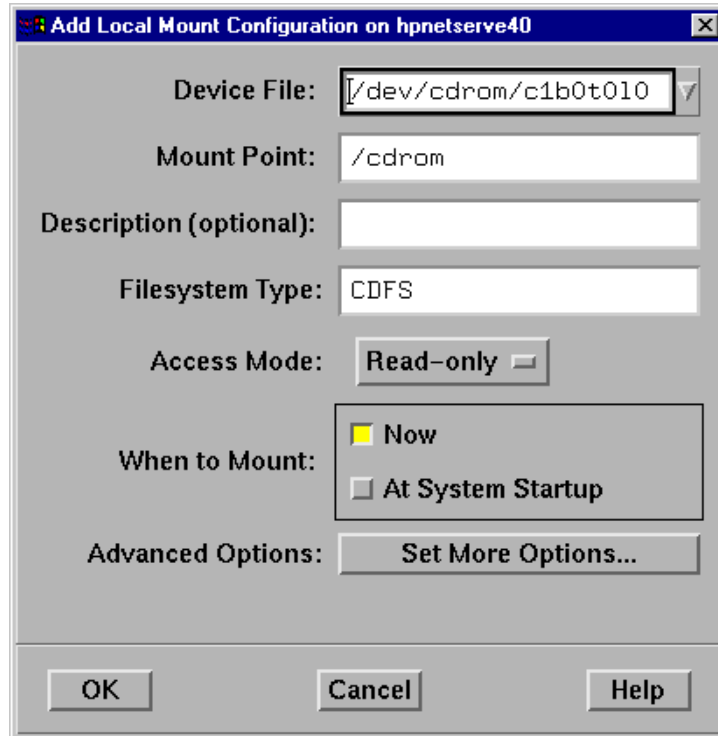

- In the Add Local Mount Configuration window, set only the options detailed in the next table:

Option	Set to or enter....
Device File	Select cdrom or string containing cdrom
Mount Point	/cdrom
Access Mode	Select Read-only
When to Mount	Enable Now Disable At System Startup

- In the Add Local Mount Configuration window, click on **OK** to accept the settings and close the window.

The Filesystem Manager window is now updated to show the new mount as shown in the next picture.

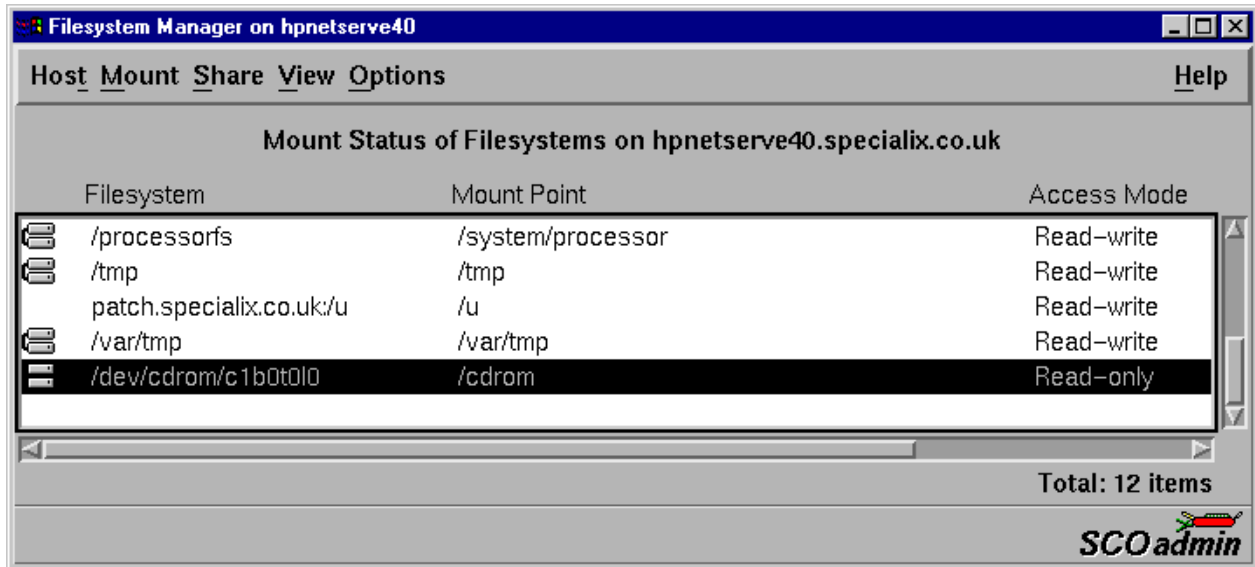

- Filesystem Manager menu, click on **Host > Exit** to close the window.

- At the command prompt, type:
pkgadd -d /cdrom/drivers/io8plus/unixware/io8.pkg.dd io8

- Press the **Enter** key.

The system now installs the driver and displays a series of messages ending with the prompt shown in the next picture.

```
Installation of I/O8+ Driver (io8) was successful.
```

- At the prompt type **q** and press the **Enter** key.
- At the command prompt, type **shutdown -y -i6** and press the **Enter** key to shutdown and re-boot your system.

Upon completion of the system re-boot the I/O8+ drivers you have installed are ready to use.

Assigning ISA host card addresses and IRQ levels

The Unixware Device Configuration Utility allows you to define and edit addresses and IRQ levels for I/O8+ host cards you add to the system.

This section includes the following;

- [Starting the Unixware Device Configuration Utility](#) on page **65**
- [Adding a new host card address](#) on page **67**
- [Editing a host card address](#) on page **47**
- [De-activating a host card](#) on page **70**
- [Exiting the Device Configuration Utility](#) on page **72**

Note

If you make any changes to the host card addresses on the system, you will need to rebuild the UNIX kernel. See [Re-building the kernel](#) on page **50** for details.

Starting the Unixware Device Configuration Utility

UnixWare provides a mechanism for adding and removing device hardware with the Device Configuration Utility. You will need to use this utility in order to add any ISA cards to your configuration.

Note

I/O8+ PCI cards are automatically detected by the operating system. You do not need to add them manually.

You can start the Device Configuration Utility using either the command prompt or the SCO UnixWare System Administration tool. See the following;

- [Command prompt method](#) on page 65
- [System Administration tool method](#) on page 66.

Command prompt method

To start the Device Configuration Utility from the command prompt, proceed as follows;

- At the command prompt, type **dcu** and press the **Enter** key.
The Unixware Device Configuration Utility window is now displayed.

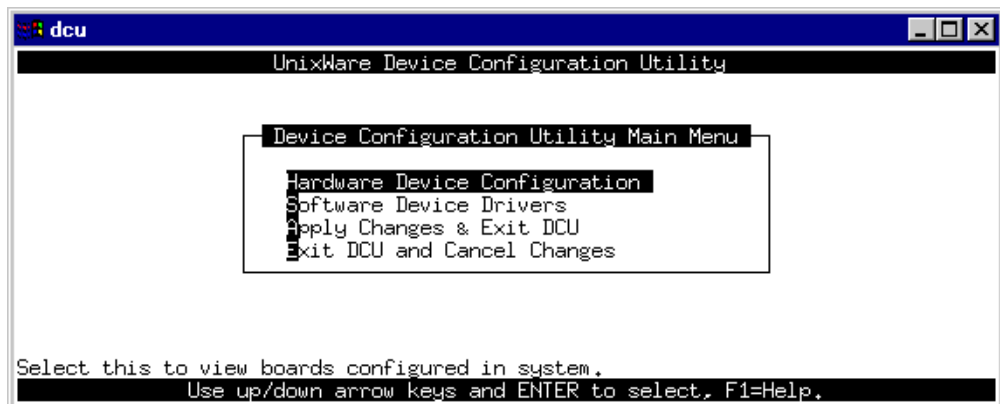

You can now use the Device Configuration Utility to configure or display host card addresses and IRQ levels. See [Adding a new host card address](#) on page 67.

System Administration tool method To start the Device Configuration Utility from the SCO UnixWare System Administration tool, proceed as follows;

1. At the command prompt, type **scoadmin**
The System Administration window is now displayed

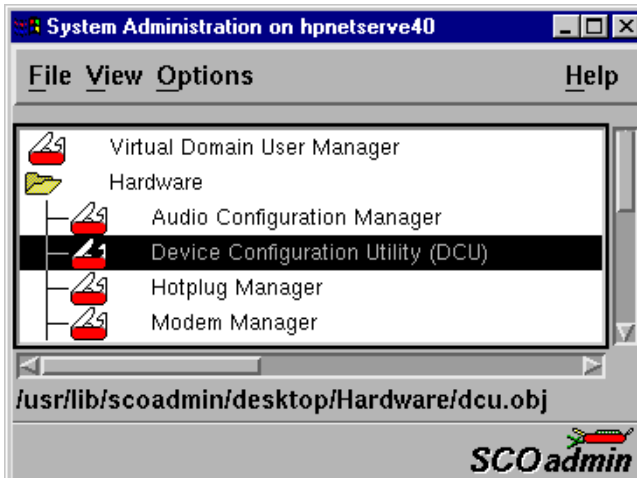

2. In the System Administration tool window, click on the Hardware folder and then select **Device Configuration Utility (DCU)**

The Unixware Device Configuration Utility window is now displayed.

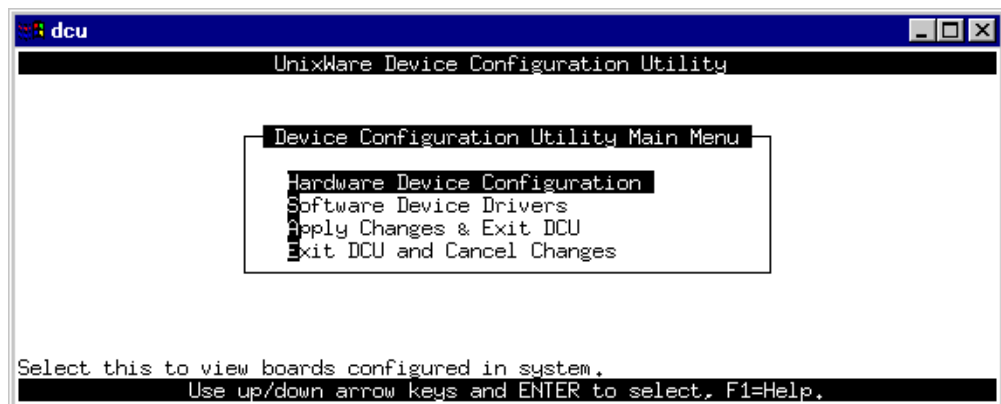

You can now use the Device Configuration Utility to configure or display host card addresses and IRQ levels. See [Adding a new host card address](#) on page 67.

Adding a new host card address

In order to function, each ISA host card must be allocated an available I/O address and IRQ level. The Device Configuration Utility allows you to determine the available addresses and IRQ levels, then allocate them to a particular host card. To do this proceed as follows;

1. Start the Unixware Device Configuration Utility. See [Starting the Unixware Device Configuration Utility](#) on page 65.
2. In the Device Configuration Utility Main Menu, click on **Software Device Drivers**.
The Software Device Driver Selections window is now displayed.

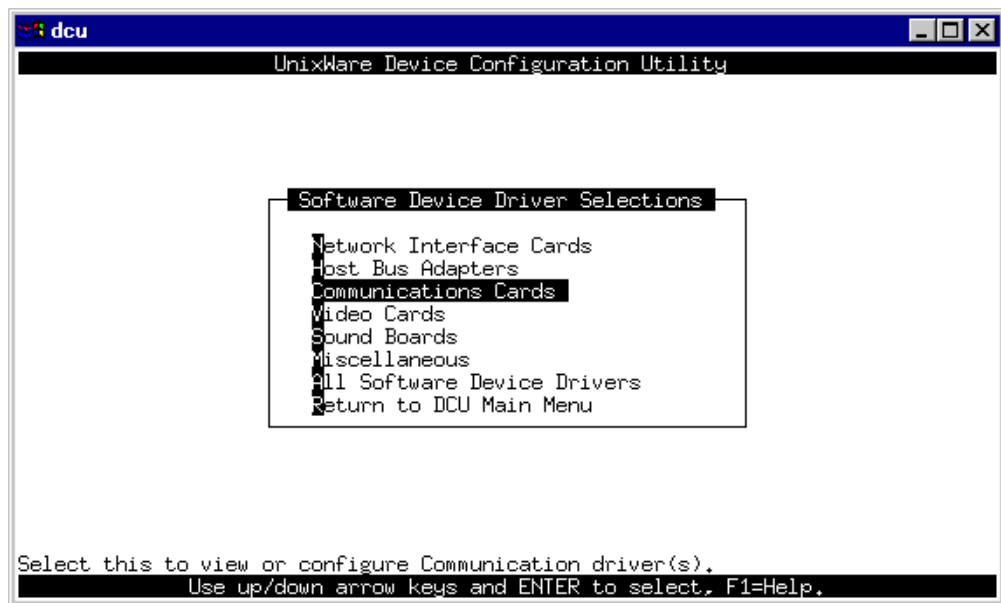

3. In the Software Device Driver Selections window, select **Communications cards** using the up and down arrow keys and press the **Enter** key to confirm your selection.
The Software Device Drivers window is now displayed as shown in the next picture.

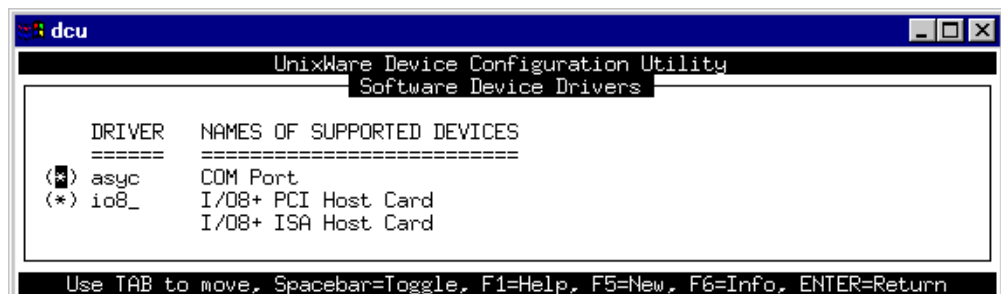

4. In the Software Device Drivers window, select the host card you want using the up and down arrow keys and then press the space bar to activate the card (denoted by a star symbol).

5. Press the **F5** key.

The New Hardware Configuration window is now displayed.

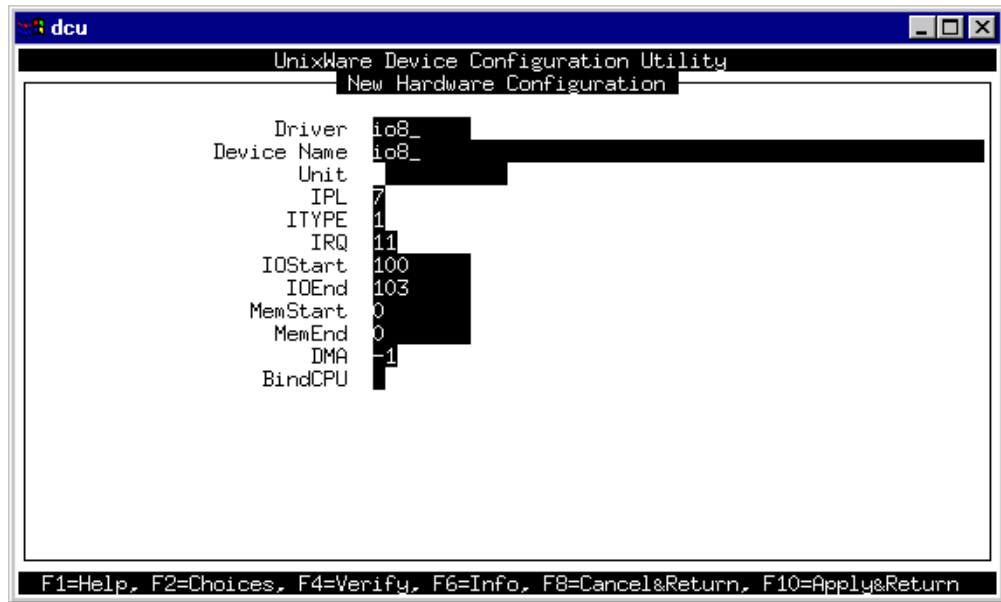

6. In the New Hardware Configuration window, select **IRQ** using the up and down arrow keys and type in the new IRQ value you want to assign for the selected host card.
7. Repeat step 6. to set the upper and lower address values **IOStart** and **IOEnd**. Use the same procedure to set **MemStart** and **MemEnd** to **0** so they are not used.

Note

The Host card address values you enter must be in hexadecimal and match the corresponding settings on the host cards. To obtain the correct hexadecimal address from the binary value set on ISA host cards, see [Appendix C ISA host card address settings](#).

8. Repeat steps 4. to 7. until you have set all the IRQ levels and addresses for all the host cards you require.
9. Press the **F10** key to accept the new values and close the window.

Editing a host card address

Note

You can only edit **ISA** card properties. **PCI** card properties are set by the operating system and cannot be changed by the user.

The Device Configuration Utility allows you to edit existing host card addresses and IRQ levels. To do this proceed as follows;

1. Start the Unixware Device Configuration Utility. See [Starting the Unixware Device Configuration Utility](#) on page 65.
2. In the Device Configuration Utility Main Menu, click on **Hardware Device Configuration**. The Hardware Device Configuration window is now displayed.

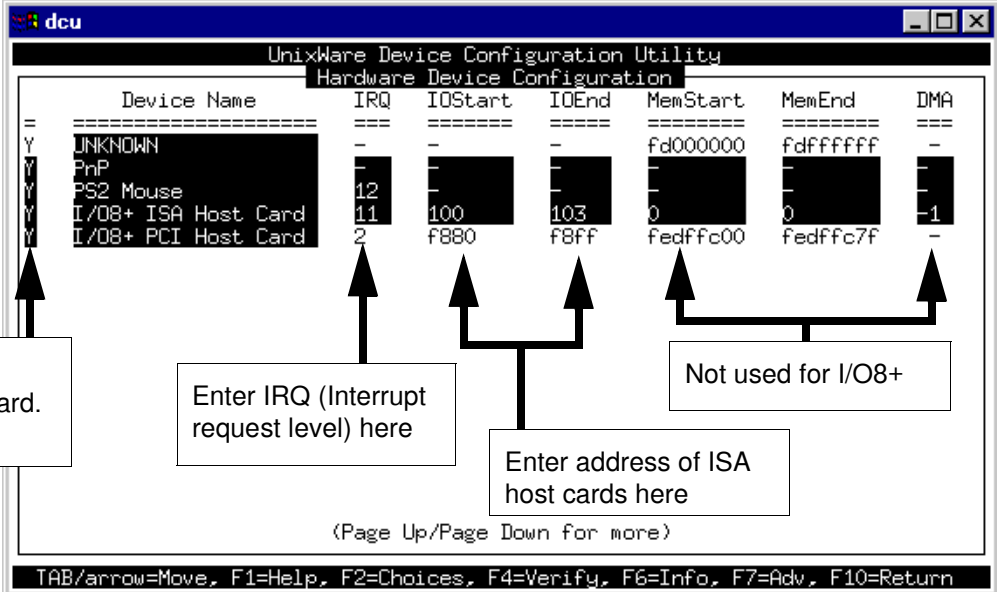

Device Name	IRQ	IOStart	IOEnd	MemStart	MemEnd	DMA
UNKNOWN	-	-	-	fd000000	fdffffff	-
PrnP	-	-	-	-	-	-
PS2 Mouse	12	-	-	-	-	-
I/O8+ ISA Host Card	11	100	103	0	0	-1
I/O8+ PCI Host Card	2	F880	F8ff	fedffc00	fedffc7f	-

Annotations in the screenshot:

- Activate (Y) or de-activates (N) a host card. (points to the 'Y' in the first column)
- Enter IRQ (Interrupt request level) here (points to the IRQ column)
- Enter address of ISA host cards here (points to the MemStart and MemEnd columns)
- Not used for I/O8+ (points to the DMA column)

(Page Up/Page Down for more)

TAB/arrow=Move, F1=Help, F2=Choices, F4=Verify, F6=Info, F7=Adv, F10=Return

3. In the Hardware Device Configuration window, use the tab key move the cursor to the host card IRQ or address you wish to change.
4. At the selected location, type in the new IRQ or address value you want to assign for the selected host card.

Note

The Host card address values you enter must be in hexidecimal. To obtain the correct hexidecimal address from the binary value set on ISA host cards, see [Appendix C ISA host card address settings](#).

5. Repeat steps 3. to 4. until you have set all the IRQ levels and addresses you require.

6. Press the **F10** key to confirm your changes and close the window.

De-activating a host card

To deactivate an installed host card proceed as follows;

1. Start the Unixware Device Configuration Utility. See [Starting the Unixware Device Configuration Utility](#) on page 65.
2. In the Device Configuration Utility Main Menu, click on **Hardware Device Configuration**
The Hardware Device Configuration window is now displayed.

Device Name	IRQ	IOStart	IOEnd	MemStart	MemEnd	DMA
UNKNOWN	-	-	-	Fd000000	FdFFFFFF	-
PS2 Mouse	12	-	-	-	-	-
I/O8+ ISA Host Card	11	100	103	0	0	-1
I/O8+ PCI Host Card	2	F880	F8FF	Fedffc00	Fedffc7f	-

Annotations:

- Activate (Y) or de-activates (N) a host card. (points to the 'Y' in the first column)
- Enter IRQ (Interrupt request level) here (points to the '11' in the IRQ column)
- Enter address of ISA host cards here (points to the '100' and '103' in the IOStart and IOEnd columns)
- Not used for I/O8+ (points to the '0' and '0' in the MemStart and MemEnd columns)

(Page Up/Page Down for more)

TAB/arrow=Move, F1=Help, F2=Choices, F4=Verify, F6=Info, F7=Adv, F10=Return

3. In the Hardware Device Configuration window, use the tab key to move the cursor to the activate/deactivate field for the host card you want as shown in the next picture.

Annotation: Type **N** here to deactivate a host card.

4. At the selected field type **N** to deactivate the host card (to re-activate type Y).
5. Repeat steps 3. to 4. until you have set all the IRQ levels and addresses you require.
6. Press the **F10** key to accept the new values and close the window.

Displaying software device driver details

To display details of the software device drivers present on your system proceed as follows;

1. Start the Unixware Device Configuration Utility. See [Starting the Unixware Device Configuration Utility](#) on page 65.
2. In the Device Configuration Utility Main Menu, click on **Hardware Device Configuration**.

The Hardware Device Configuration window is now displayed showing details of the software device drivers present on your system.

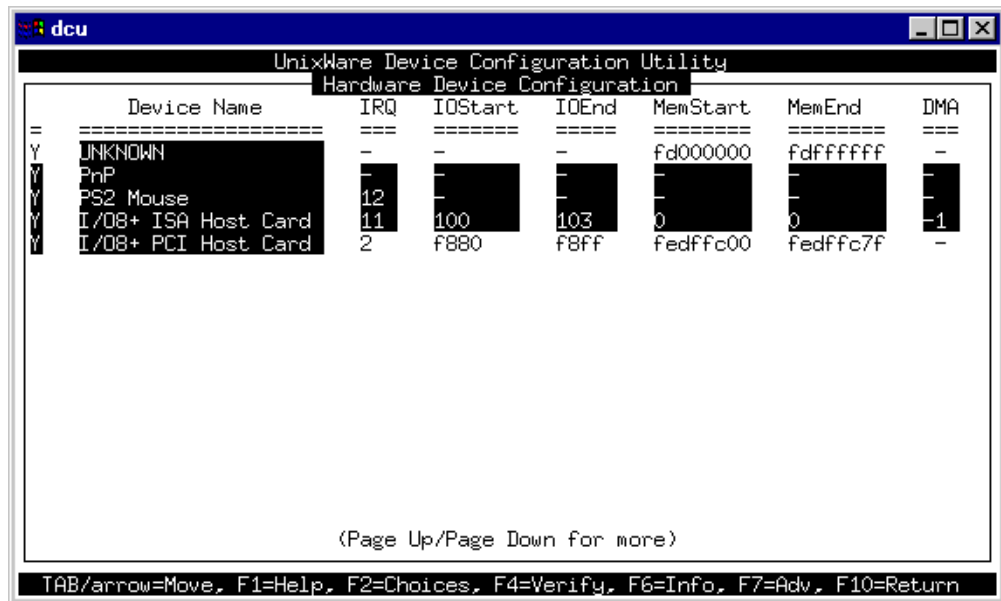

3. Press the **F10** key to confirm your changes and close the window.

Exiting the Device Configuration Utility

Quitting and saving To exit the Device Configuration Utility and save any changes you have made, proceed as follows;

1. In the Device Configuration Utility Main Menu, click on **Apply Changes & Exit DCU**.
The Device Configuration Utility now closes and saves any changes you have made.

Note

To quit the Host Card Configuration utility without saving any changes:

- In the In the Host Card Configuration menu, click on **Exit DCU and Cancel Changes**.

Note

In most cases the kernel will need to be rebuilt in order for the changes to take effect to do this proceed as follows;

1. Login to your system as super user.
2. At the command prompt, type **/etc/conf/bin/idbuild** and press the **Enter** key.
You are now prompted to re-boot the system.
3. At the command prompt, type **Shutdown -i6 -y** to re-boot the system.

The system now re-boots displaying messages as it does so.

Configuring serial ports

The software provided with the I/O8+ for the SCO UnixWare operating system includes a utility called Serial Manager which allows you to configure the extra I/O8+ serial ports you have added to your system.

Note

If you are running version 2 of the SCO UnixWare operating system you need to use the procedures described in [Configuring serial ports under SCO UnixWare 2](#) on page 78 to configure your serial ports.

Note

On UnixWare 7.0, you must apply a patch file called **ptf7053** before using the Serial Manager. You can find the patch on the SCO web site at;

<http://www.sco.com>

To configure serial ports with Serial Manager proceed as follows;

Note

If you want to perform transparent printing from any of the terminals attached to your system, you need to check the contents of the **printcap.io8** file to see if the terminal type you are using is supported. To do this proceed as follows;

1. Using a text editor, go to the **/etc** directory and open the file called **printcap.io8**
2. Check the contents of the **printcap.io8** file to see if the terminal type you are using is supported. See [page 124](#) in [Appendix B Transparent printing](#) for the syntax of the entries in this file.
3. If the terminal type you are using is not supported, add an entry for the new terminal type (including the type, transparent print ON and transparent print OFF strings) to the **printcap.io8** file ([page 124](#)). See the user guide for your terminal for details of the entries required.
4. If you have made any changes then either re-boot using by typing **Shutdown -i6 -y** or type **io8cfg** in order to re-configure the print port settings.

You can now configure the ports you want using the Serial Manager utility.

1. At the command prompt, type **scoadmin**

The System Administration window is now displayed as shown in the next picture.

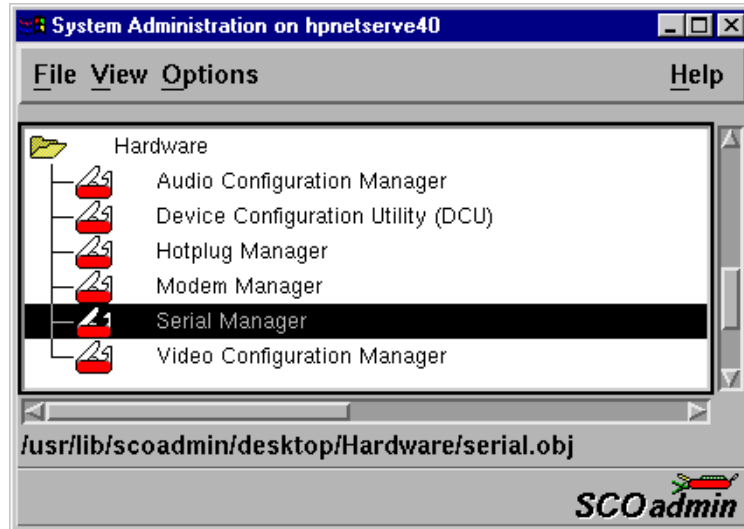

2. In the System Administration tool window, click on the Hardware folder and then select **Serial Manager**

The Serial Manager window is now displayed showing the host cards (including I/O8+) currently present on the system.

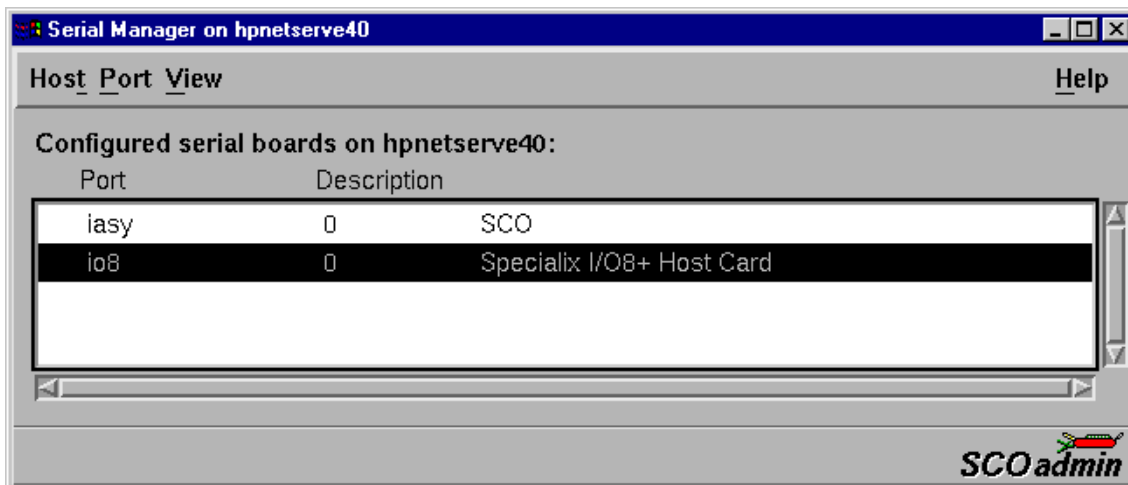

- In the Serial Manager window, select the host card you want. Then in the Serial Manager menu, click on **View > Ports** .

The Serial Manager window now displays the ports available for the selected host card as shown in the next picture.

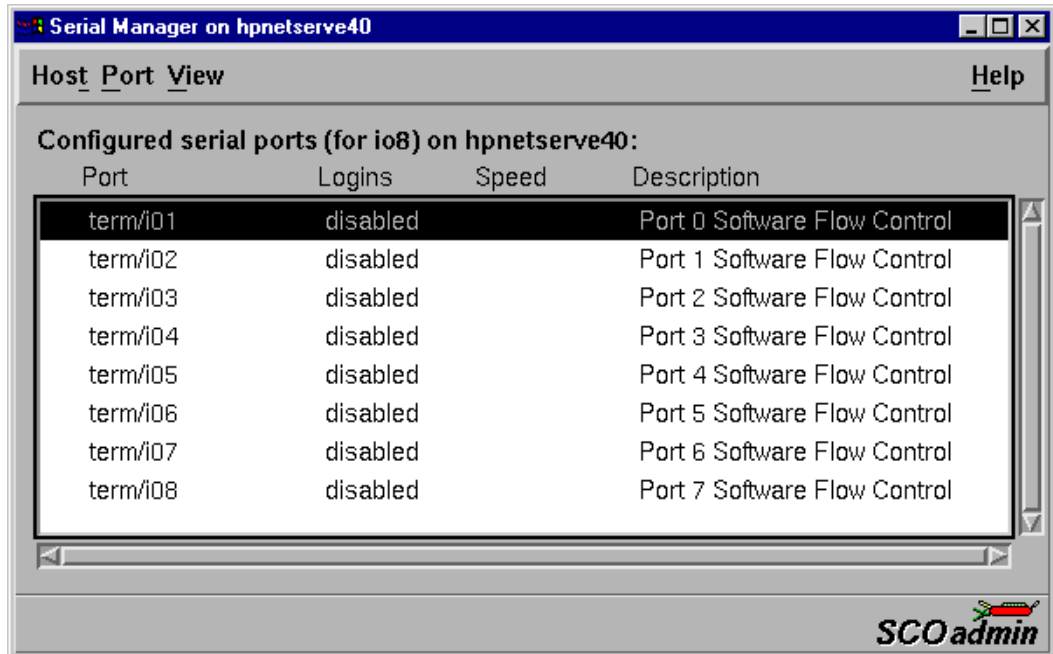

- In the Serial Manager menu, click on **Port > Modify** .
The Modify Serial Port window is now displayed.

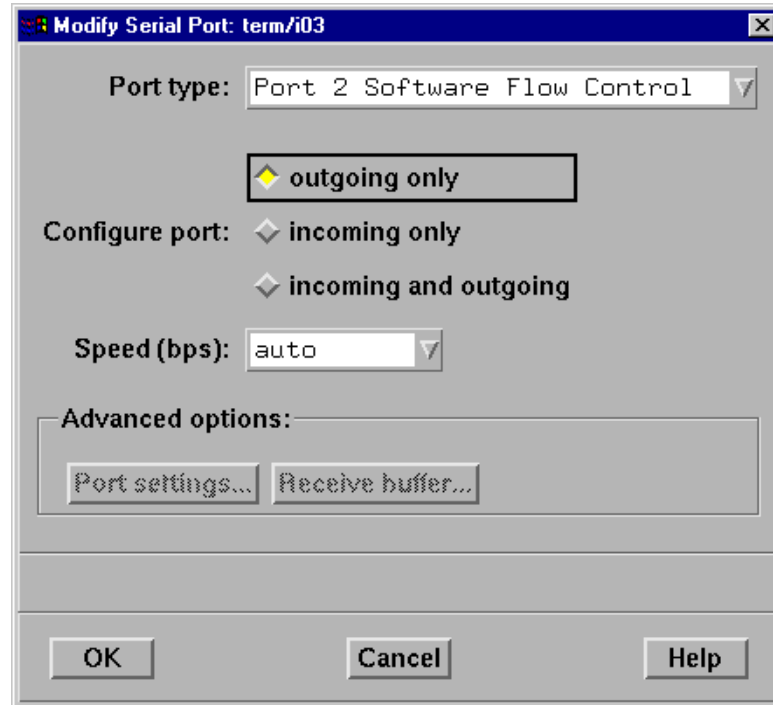

- In the Modify Serial Port window, set the parameters shown in the next table

Parameter	Set to
Port Type	No change, should already be set to software flow control
Configure port	incoming only
Speed	the speed value you require

- In the Modify Serial Port window, click on the **Port settings** button.
The Port settings window is now displayed.

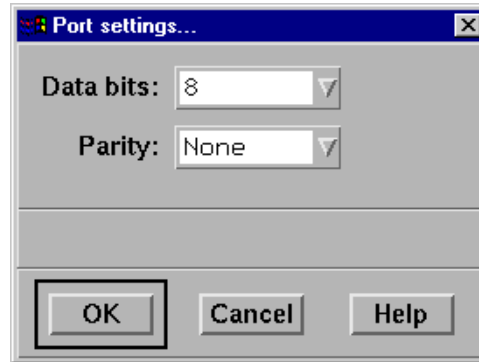

- In the Port settings window, select the **Data bits** and **Parity** values you require and click on **OK**.
- In the Modify Serial Port window, click on OK to accept the changes you have made and close the window.
- Repeat steps 3. to 8. until you have configured the serial ports for all the host cards you require.
- In the Serial Manager menu click on **Host > Quit** to quit Serial Manager and close the window.

Configuring serial ports under SCO UnixWare 2

spxadmpport

SCO UnixWare 2 does not include the graphical user interface based Serial Manager utility. If you are running SCO UnixWare 2 on your computer, you need to run the **spxadmpport** script from the command line to configure I/O8+ serial ports. You use this by typing a single line command which contains the information required for a given configuration task using the following syntax;

Syntax /etc/spxadmpport **command svctag [label] [owner]**

where;

Item	Description	Example
command	add, enable, disable, remove or list.	remove
svctag	device number from /dev/term.	i01
label	/etc/ttydefs entry (optional).	9600
owner	user ID assigned to the port (optional).	root

Procedure

To use the **spxadmpport** script to configure your I/O8+ serial ports proceed as follows;

1. At the command prompt, type one of the commands detailed in the next table using the following syntax;

/etc/spxadmpport [**command**] [**svctag**] [**label**] [**owner**]

Command	Description	Example command
Add	Adds a serial port to the service monitor (io8mon) and enables the port for monitoring logins.	/etc/spxadmpport add i01 9600 root
Enable	Enables a previously disabled port for monitoring.	/etc/spxadmpport enable
Disable	Disables a port. Has the effect of disabling all further logins on this port.	/etc/spxadmpport disable i01
Remove	Removes the selected serial port from the service monitor (io8mon).	/etc/spxadmpport remove i01
List	Lists the currently defined services and/or port monitors.	/etc/spxadmpport list
List p	Lists all logins configured.	/etc/spxadmpport list p
List s	Lists all port services configured.	/etc/spxadmpport list s

2. Press the **Enter** key.

The revised I/O8+ port configuration is now adopted by the system.

Removing I/O8+ drivers and utilities from your system

To remove the software drivers from your system under the SCO UnixWare operating system proceed as follows;

Note

Before removing a software driver you should first de-activate all I/O8+ host cards present on the system. See [De-activating a host card](#) on page 70.

1. At the command prompt, type **pkgrm io8** and press **Enter**

The I/O8+ driver and associated utilities are now removed from your system.

Installing an I/O8+ PCI host card under Windows 2000/XP/Server 2003/Vista/Server 2008

This section describes how to install the PCI host card I/O8+ device driver software under Microsoft Windows 2000/XP/Server 2003/Vista/Server 2008.

This section includes the following:

- [General PCI host card installation procedure for Windows 2000/XP/Server 2003/Vista/Server 2008](#) on page 80
- [Installing PCI host card device drivers and utilities onto your system](#) on page 81
- [Updating I/O8+ PCI host card device drivers with update.exe](#) on page 83
- [Configuring PCI host card serial ports](#) on page 85.

General PCI host card installation procedure for Windows 2000/XP/Server 2003/Vista/Server 2008

The general procedure for installing an I/O8+ PCI host card under the Windows 2000/XP/Server 2003/Vista/Server 2008 operating systems is as follows:

1. Install or remove any PCI host cards you require on your system. See [Installing a PCI host card](#) on page 100 and [Removing host cards](#) on page 103.
2. Using the I/O8+ installation wizard, install the I/O8+ device driver software. See [Installing PCI host card device drivers and utilities onto your system](#) on page 81.
3. Using the Windows **Device Manager**, configure the serial ports you have added to the system. See [Configuring PCI host card serial ports](#) on page 85.

Installing PCI host card device drivers and utilities onto your system

To install or enable the I/O8+ device drivers on your system proceed as follows:

1. Turn on your PC and if required, log in.

If you have installed any new host cards a Found New Hardware message is briefly shown followed by the Found New Hardware wizard as shown in the pictures.

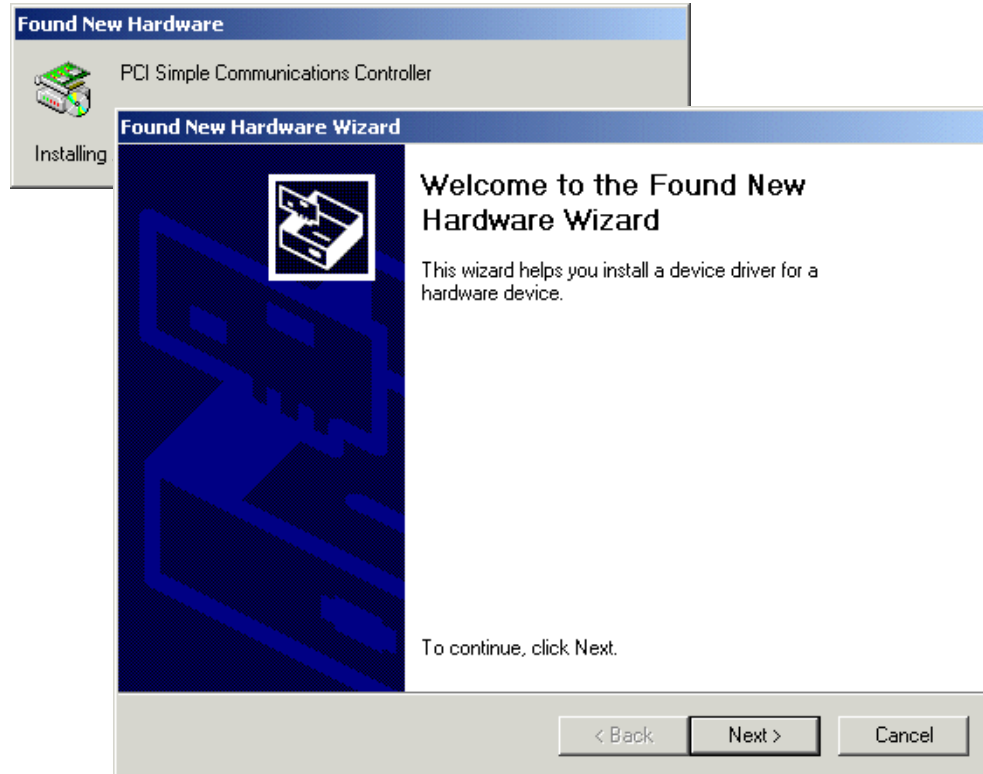

2. In the Found New Hardware wizard click on the **Cancel** button.
3. Download the latest I/O8+ driver zip file from the Perle website for your operating system:
 - io8-x86.zip** for 32-bit Windows operating systems.
 - io8-amd64.zip** for 64-bit Windows operating systems.
 - io8-ia64.zip** for 64-bit Windows Itanium operating systems.
4. Unzip the driver zip file to a local directory. We recommend that you use the **io8-setup-*<arch>*.exe** file when installing the drivers for a I/O8+ PCI card, which will launch the installation wizard, to install the I/O8+ driver.

5. Double-click the `io8-setup-<arch>.exe` installation executable and follow the installation wizard steps:



6. During the installation, you may get a Windows Logo message. Click **Continue Anyway** when these appear.

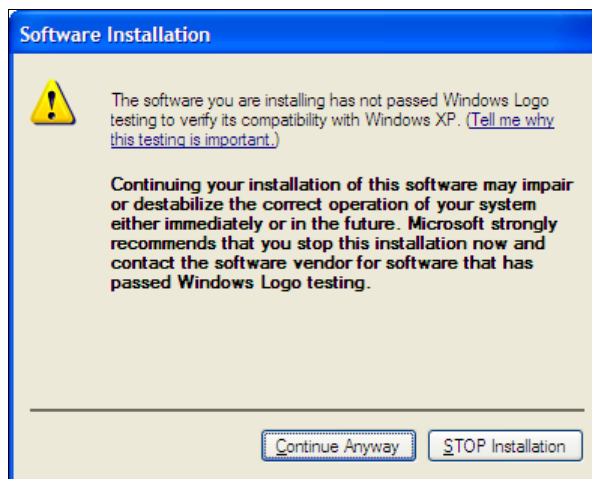

Note

If you are installing an unsigned driver, you may have to click through the Found New Hardware wizard for every IO8+ card on your system.

7. Your I/O8+ driver installation is now finished.

Updating I/O8+ PCI host card device drivers with update.exe

Whenever you add any SX, I/O8+ or SI/XIO hardware to your system, by default Windows will use its latest digitally signed driver in its driver database. To ensure you install the latest driver you must now run the **update.exe** program. This ensures that every device currently installed in the system is updated to use the driver on the CDROM.

To run **update.exe**, proceed as follows:

1. In the Windows desktop, click on the **Start** button and select the **Run** option.

The Run window is now displayed.

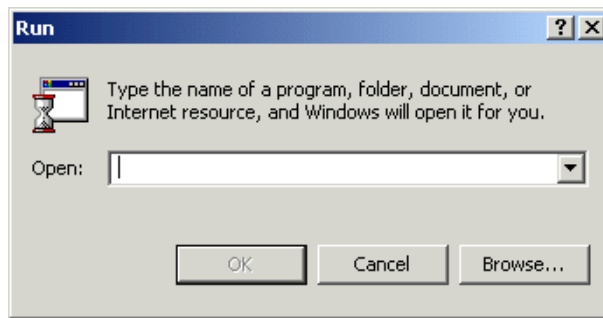

2. In the run window enter the path and program name (**update.exe**), then click on the **OK** button.

The Device Driver Updater Wizard is now displayed as shown in the next picture.

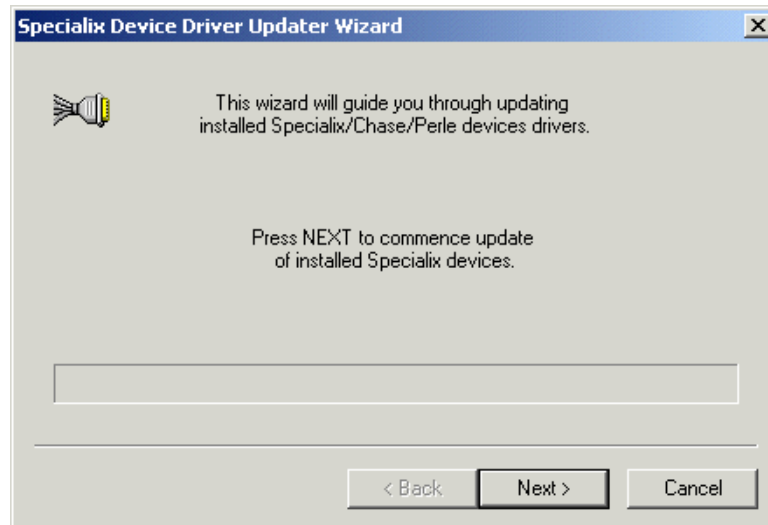

3. In the Perle Device Driver Updater Wizard, click on the **Next >** button.
A progress message is now displayed while the drivers are updated. This is then followed by the closing message window.

4. In the closing page, click on the **FINISH** button to complete driver installation.

Configuring PCI host card serial ports

To configure I/O8+ serial ports under Windows 2000/XP/Server 2003/Vista/Server 2008, proceed as follows:

1. In the Windows 2000 desktop, click on the **Start** button and select **Settings > Control Panel**.

The control panel window is now displayed.

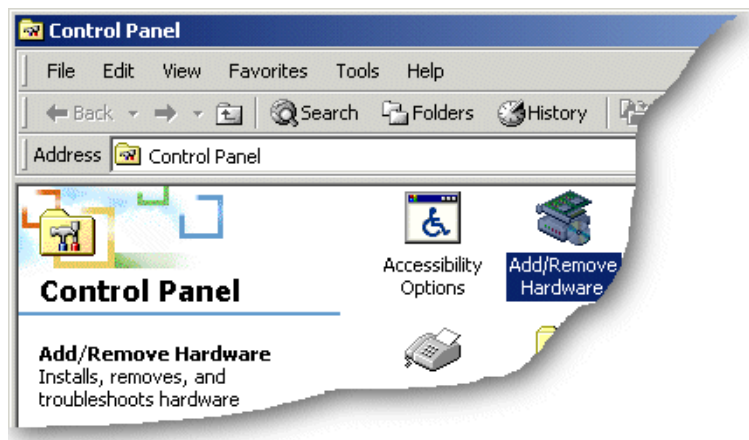

2. In the Control Panel window, click on the **System** icon.
The System Properties tabbed window is now displayed.
3. In the System Properties window, click on the **Hardware** tab.
The hardware page is now displayed.

4. In the Hardware page, click on the **Device Manager** Button.
The Device Manager window is now displayed.

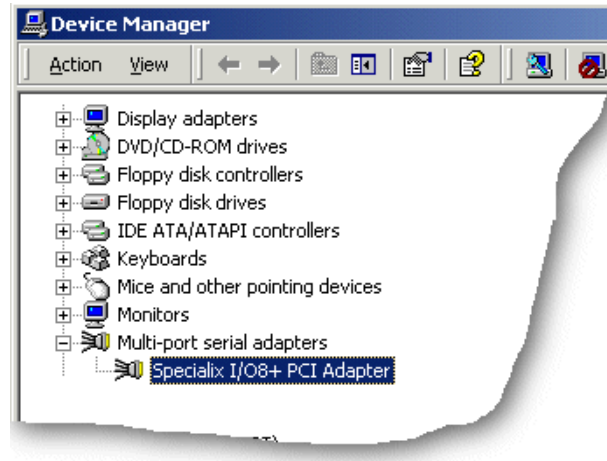

5. In the Device Manager window, click on the Multiport serial adapters icon to display the currently installed devices.
6. In the Device Manager window, double click on the device whose properties you want to view or change
The device Properties tabbed window is now displayed.

7. In the device Properties window, click on the **Port Settings** tab to display the Port Settings page.

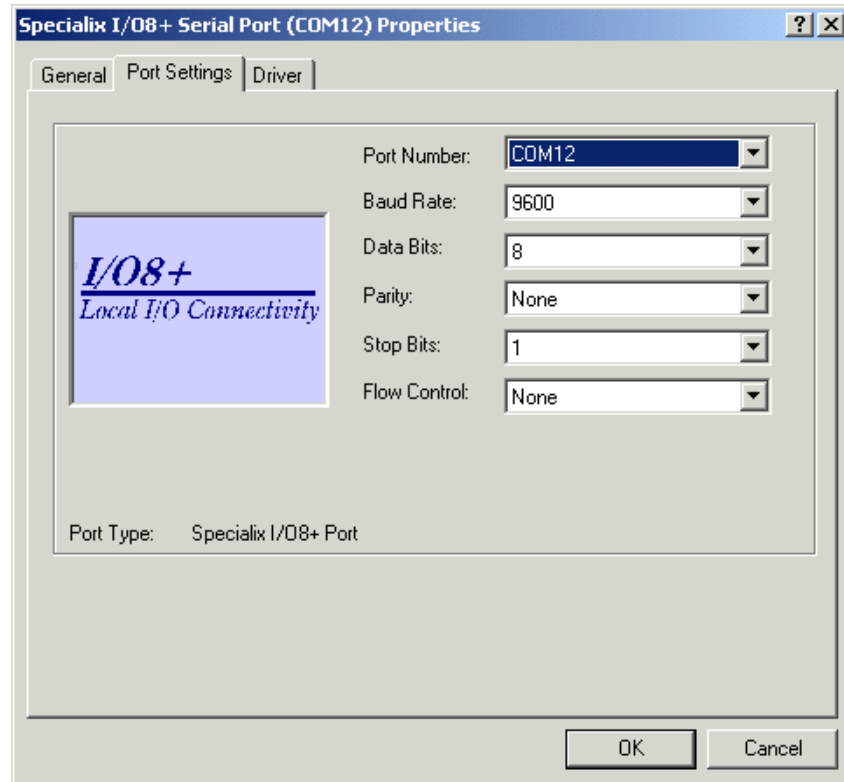

8. In the Port Settings page, set the **Port Number**, **Baud Rate** and other configuration parameters you require and then click on the **OK** button to save changes and close the window.

The configuration process is now complete.

Installing an I/O8+ ISA host card under Windows 2000

This section describes how to install the I/O8+ device driver software for the ISA host card under Microsoft Windows 2000.

This section includes the following:

- [General ISA host card installation procedure for Windows 2000](#) on page [88](#)
- [Adding ISA host cards to the system](#) on page [22](#)
- [Viewing and changing the ISA host card resources for a device](#) on page [93](#)
- [Updating I/O8+ ISA host card device drivers with update.exe](#) on page [97](#)
- [Configuring ISA host card serial ports](#) on page [98](#).

General ISA host card installation procedure for Windows 2000

The general procedure for installing I/O8+ under the Windows 2000 operating system is as follows:

1. If required, install any ISA host cards you require into your system. See [Installing an ISA host card](#) on page [101](#).
2. If required, using the Windows 2000 **Add/Remove Hardware wizard**, add any additional ISA host cards to the list of installed devices on the system using the free addresses available. See [Adding ISA host cards to the system](#) on page [89](#).
3. Repeat step [2](#). until you have added all the ISA host cards you want to install.

Note

The drivers for I/O8+ are included on your Windows 2000 CDROM.

Whenever you add any SX, I/O8+, or SI/XIO hardware to your system, by default Windows 2000 will use its latest digitally signed driver in its driver database. To ensure you install the latest driver you must now run the **update.exe** program. This ensures that every device currently installed in the system is updated to use the driver on the CDROM (version 8 or later).

See [Updating I/O8+ ISA host card device drivers with update.exe](#) on page [97](#).

4. Using the Windows 2000 **Device Manager**, configure the serial ports you have added to the system. See [Configuring PCI host card serial ports](#) on page [85](#).
5. If required, remove any host cards you want from your system. See [Removing host cards](#) on page [103](#).

Adding ISA host cards to the system



When you physically install an ISA host card in your system you also need to add the card to the list of installed devices in the system.

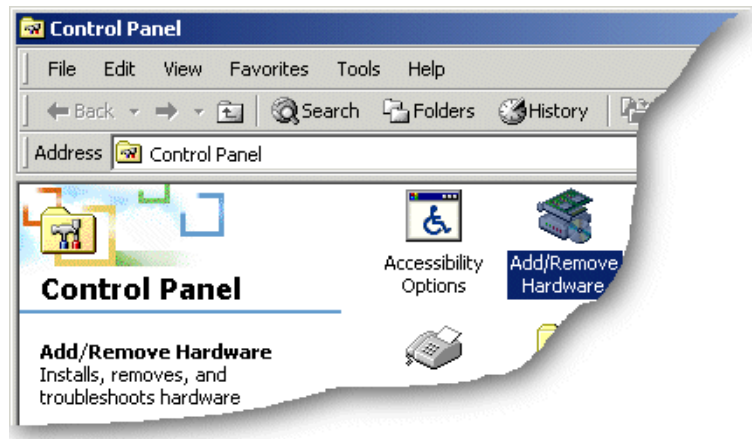

To add ISA host cards to your system, proceed as follows:

1. In the Windows desktop, click on the **Start** button and select **Settings > Control Panel**.
The control panel window is now displayed.

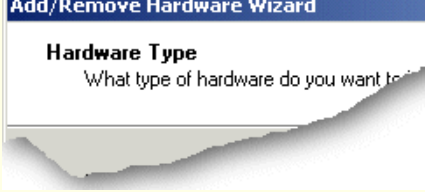

2. In the control panel window, double click on the **System** icon.
The Add/Remove Hardware Wizard is now displayed.
3. Using the instructions given in the next table, use the Add/Remove Hardware Wizard to assign the host card addresses and IRQ levels you require.

In this Wizard page	Do the following...
 <p>Add/Remove Hardware Wizard Choose a Hardware Task Which hardware task do you want to perform?</p>	<p>4. In the Add/Remove Hardware Wizard, select Add/Troubleshoot a device and press the Next > button.</p> <p>The Choose a Hardware Device page is now displayed.</p>
 <p>Add/Remove Hardware Wizard Choose a Hardware Device Which hardware device do you want to add?</p>	<p>5. In the Choose a Hardware Device page, scroll up the list of devices and click on Add a new device, then click on the Next > button.</p> <p>The Find New Hardware page is now displayed.</p>
 <p>Add/Remove Hardware Wizard Find New Hardware Windows can also detect hardware that is not properly installed.</p>	<p>6. In the Find New Hardware page, select No, I want to select the hardware from a list and click on the Next > button.</p> <p>The Hardware Type page is now displayed.</p>
 <p>Add/Remove Hardware Wizard Hardware Type What type of hardware do you want to install?</p>	<p>7. In the Hardware Type page, select Multi-port serial adaptors and click on the Next > button.</p>

In this Wizard page	Do the following...
	<p>The Select a Device Driver page is now displayed.</p> <p>8. If your host card type isn't shown, in the Select a Device Driver page click on the Have Disk button.</p> <p>A message window is now displayed which prompts you for the driver and location you want to use.</p> <p>9. In the message window, enter or select the driver you want and click on the OK button to accept settings and close the window.</p> <p>The Select a Device Driver page is now updated to show the new driver you have selected.</p> <p>10. In the Select a Device Driver page, select the Specialix or Perle I/O8+ ISA Adapter option, then click on the Next > button.</p> <p>The Start Hardware Installation page is now displayed.</p>
	<p>11. In the Start Hardware Installation page, click on the Next > button to accept your choice.</p> <p>A completion message page is now displayed as shown in the next picture.</p>



Note

Windows 2000 will try to load the I/O8+ drivers using the default resources. If the card you are loading is not configured to use the defaults or the resources are not freely available in the system, the driver will fail to start.

If resources are not free you will have to change the resource configuration using the procedures described on [page 97](#).

12. In the completion message page click on the **Finish** button to complete the new configuration.

After the you have finished adding cards to the system all connected port devices will now be detected. Windows 2000 will try to install the latest driver for the ports from its database or will prompt you for one if one cannot be found.

Viewing and changing the ISA host card resources for a device

To view or change the resources for a device proceed as follows:

1. In the Add/Remove Hardware Wizard go to the last page and click on the Resources button.



The Add New Hardware Wizard properties window is now displayed.



- In the Add New Hardware Wizard properties window, select the **Resources** page and click on the **Set Configuration Manually** button.

The resources page is now updated to show the settings for the current installed I/O8+ device.

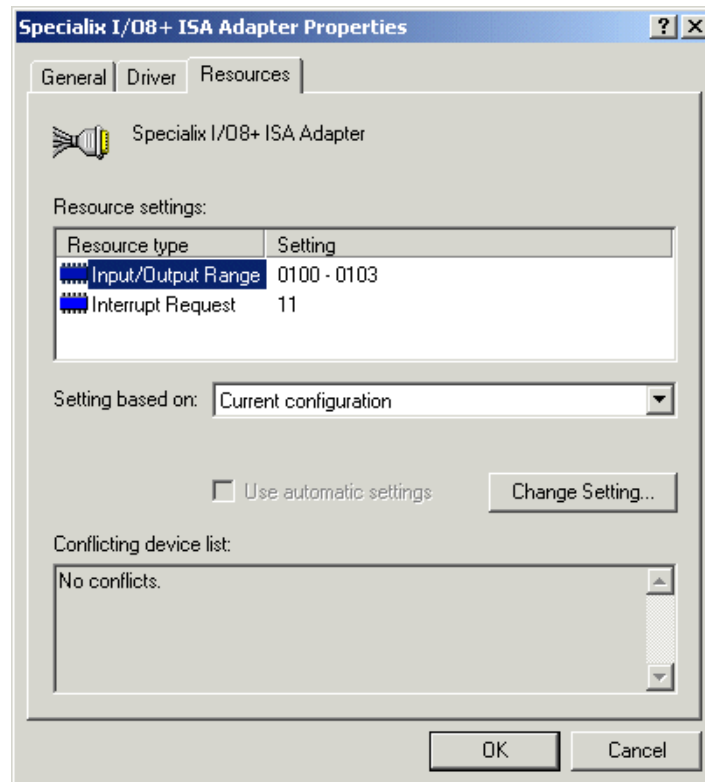

3. In the Add New Hardware Wizard properties window, select the **Input/Output Range** you require and click on the **Change Setting** button.

The Edit Input/Output Range window is now displayed.

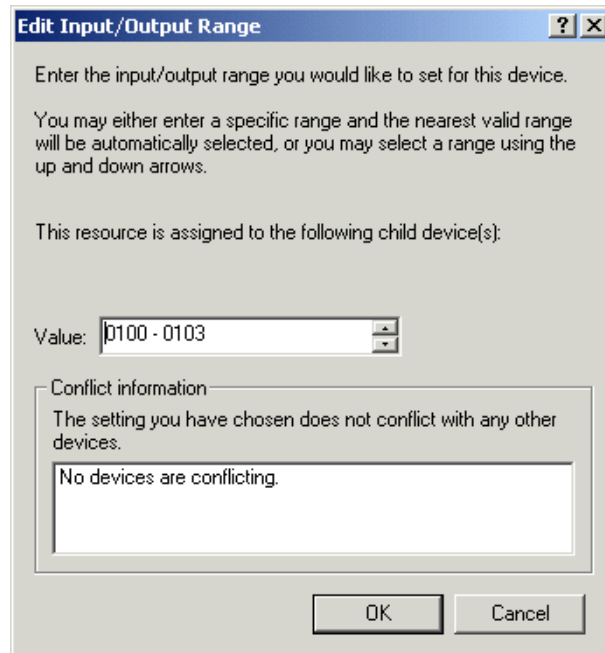

4. In the Edit Input/Output Range window, enter the memory range you want and click on the **OK** button.

If values you have selected are not acceptable to the system, then the Device Manager will display a problem icon as shown in the next picture.



5. If the I/O address you have selected are not acceptable to the system, check your configuration settings and adjust memory address as required. Otherwise ring Technical support.

- In the Add New Hardware Wizard properties window, select **Interrupt Request** you require and click on the **Change Setting** button.

The Edit Interrupt Request window is now displayed.

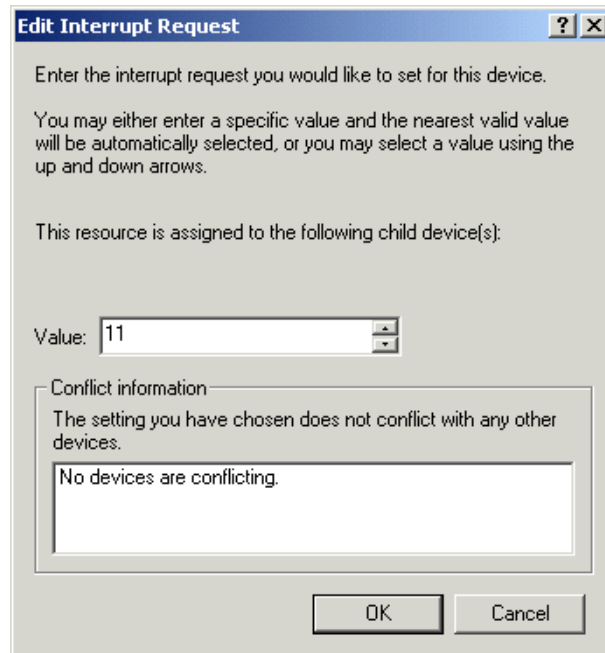

- In the Edit Interrupt Request window, select the IRQ level you want using the **Value** field and click on the **OK** button.

If value you have selected is not acceptable to the system, then the Device Manager will display a problem icon as shown in the next picture.



- If the IRQ level you have selected are not acceptable to the system, check your configuration settings and adjust the IRQ value as required. Otherwise ring Technical support. See [Contacting Perle](#) on page 108 in [Appendix D Contacting Perle](#).

Updating I/O8+ ISA host card device drivers with update.exe

Whenever you add any SX, I/O8+ or SI/XIO hardware to your system, by default Windows 2000 will use its latest digitally signed driver in its driver database. To ensure you install the latest driver you must now run the **update.exe** program. This ensures that every device currently installed in the system is updated to use the driver on the CDROM.

To run **update.exe**, proceed as follows:

1. In the Windows desktop, click on the **Start** button and select the **Run** option.

The Run window is now displayed.

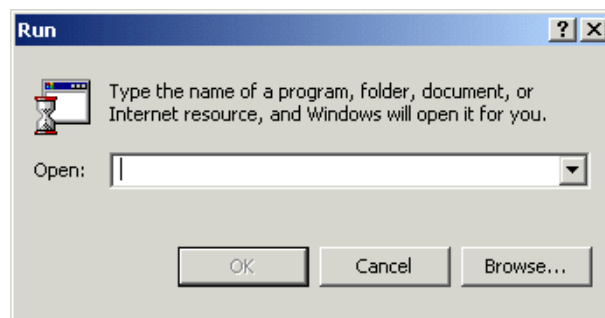

2. In the run window enter the path and program name (**update.exe**), then click on the **OK** button.

The Device Driver Updater Wizard is now displayed as shown in the next picture.

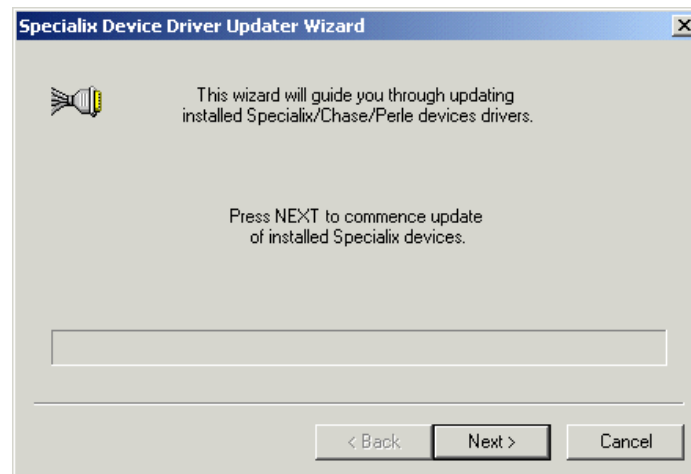

3. In the Perle Device Driver Updater Wizard, click on the **Next >** button.

A progress message is now displayed while the drivers are updated. This is then followed by the closing message window.

4. In the closing page, click on the **FINISH** button to complete driver installation.

Configuring ISA host card serial ports

To configure I/O8+ serial ports under Windows 2000, proceed as follows:

1. In the Windows 2000 desktop, click on the **Start** button and select **Settings > Control Panel**.

The control panel window is now displayed.

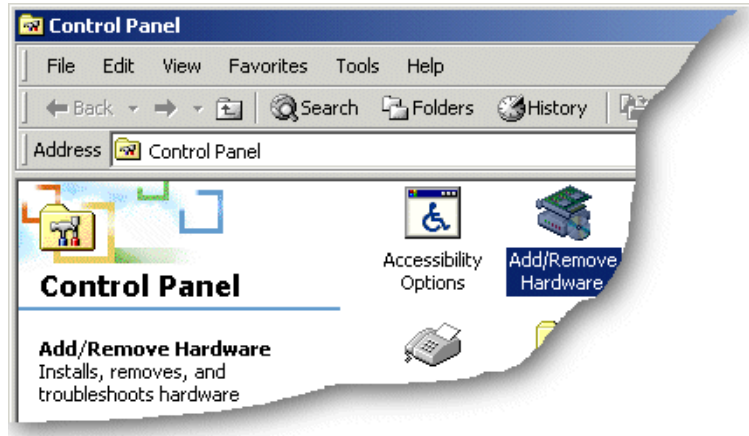

2. In the Control Panel window, click on the **System** icon.
The System Properties tabbed window is now displayed.
3. In the System Properties window, click on the **Hardware** tab.
The hardware page is now displayed.
4. In the Hardware page, click on the **Device Manager** Button.
The Device Manager window is now displayed.

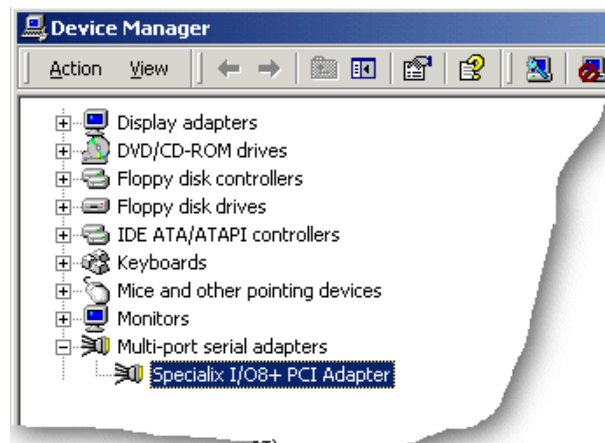

5. In the Device Manager window, click on the Multiport serial adapters icon to display the currently installed devices.
6. In the Device Manager window, double click on the device whose properties you want to view or change.
The device Properties tabbed window is now displayed.
7. In the device Properties window, click on the **Port Settings** tab to display the Port Settings page.

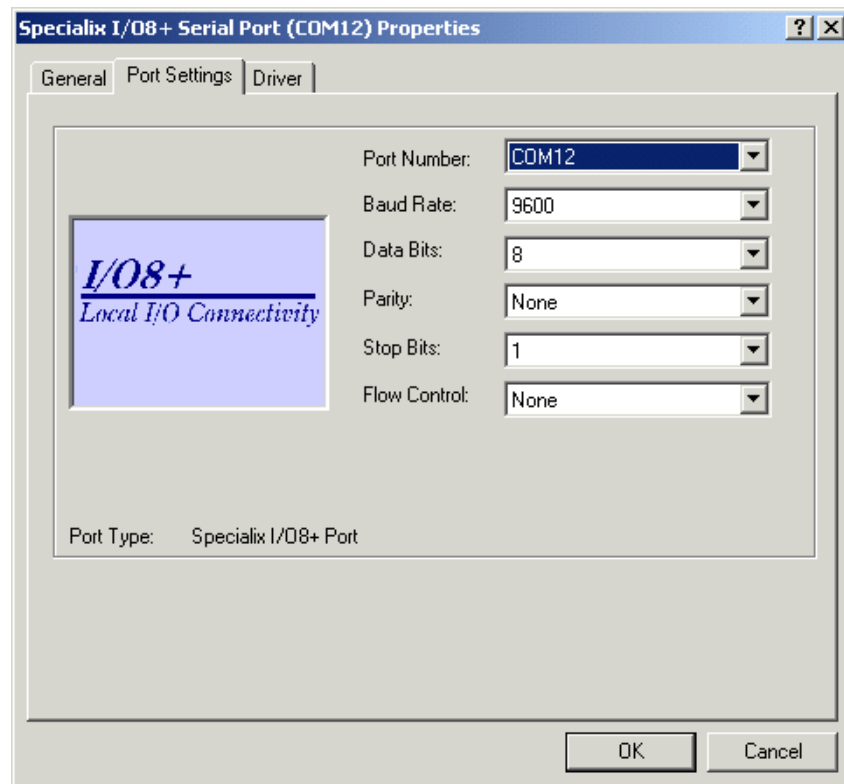

8. In the Port Settings page, set the **Port Number**, **Baud Rate** and other configuration parameters you require and then click on the **OK** button to save changes and close the window.

The configuration process is now complete.

Installing a PCI host card

To install a PCI host card proceed as follows;

Note

The exact location of host card slots varies for different systems, for exact mechanical details of your system, refer to your system documentation.



Warning

Dangerous voltages exist inside computer systems. Before installing host cards in your system, turn off the power supply and disconnect the mains lead.

1. Turn off the power to your system and disconnect the mains supply.
2. Remove the system cover to expose the inside of the connector panel for host cards.
3. Insert the PCI card you want to install into a vacant host card slot and secure in place as shown in the next picture.



Caution

Full anti-static precautions should be taken when handling host cards.

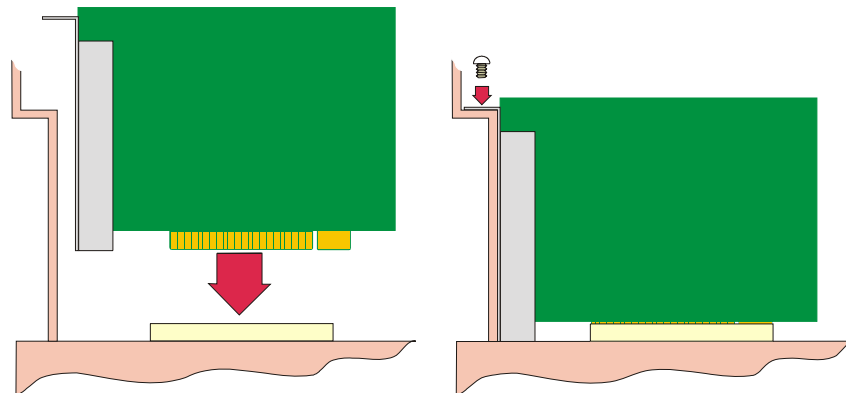

4. Repeat step 3. until you have installed all the PCI cards you want.
5. Replace and secure the system cover.

Installation of PCI host cards is now complete. For further details about installing host cards including other types, see [Before you start](#) on page 18.

Installing an ISA host card

Setting the address on an ISA host card

Before you install an ISA card in your system you need to physically set the address for the card using the DIL switch provided (shown in the next picture).

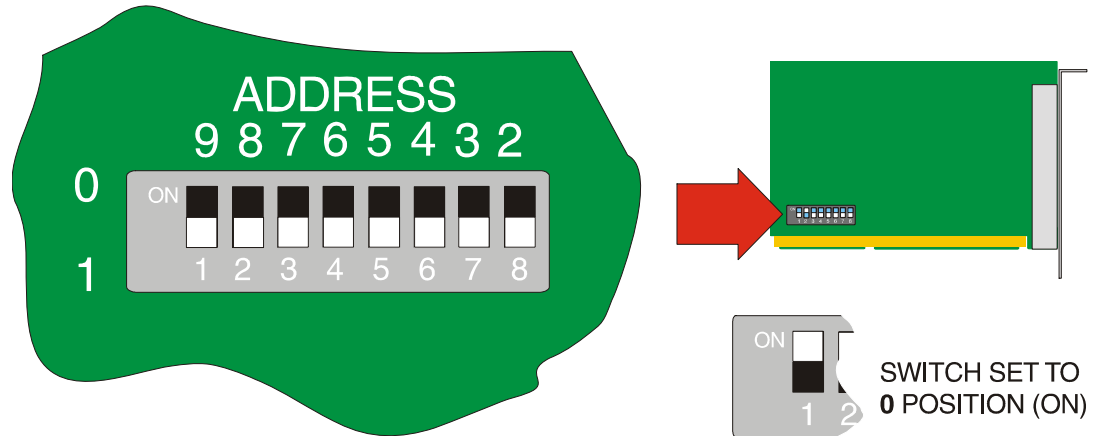

To set the address for an ISA host card proceed as follows;

Caution
Full anti-static precautions should be taken when handling host cards.

1. Convert the address you want to use into a binary value. See [Appendix C ISA host card address settings](#).
2. On the host card set the DIL switch on the host card to the selected binary address you want. The next picture shows an example DIL switch set to an address of 100_{hex} which corresponds to 01000000.

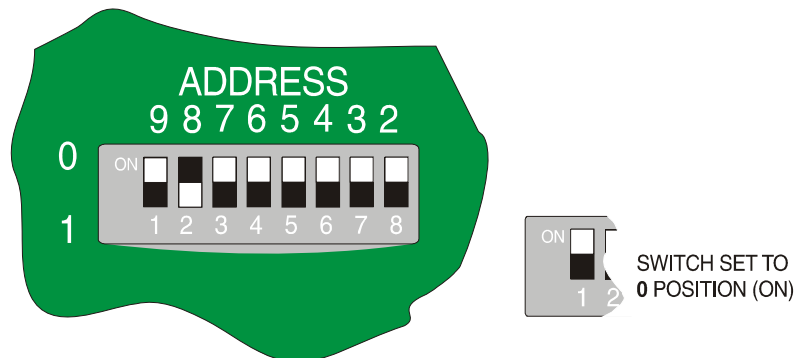

Mechanical installation

You can now install the ISA host card in your system. To do this proceed as follows;

Note

The exact location of host card slots varies for different systems, for exact mechanical details of your system, refer to your system documentation.



Warning

Dangerous voltages exist inside computer systems. Before installing host cards in your system, turn off the power supply and disconnect the mains lead.

3. Turn off the power to your system and disconnect the mains supply.
4. Remove the system cover to expose the inside of the connector panel for host cards.
5. Insert the ISA card you want to install into a vacant host card slot and secure in place as shown in the next picture.



Caution

Full anti-static precautions should be taken when handling host cards.

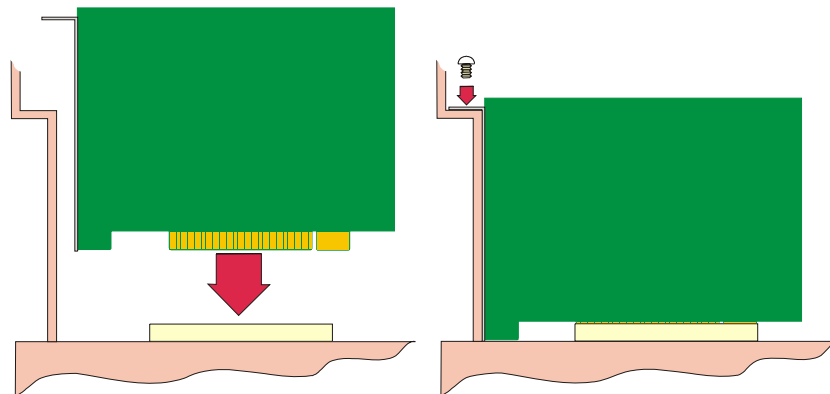

6. Repeat step 3. until you have installed all the ISA cards you want.
7. Replace and secure the system cover.
8. Plug in the mains lead and turn on the power.

Installation of ISA host cards is now complete. For further details about installing host cards including other types, see [Before you start](#) on page 18.

Removing host cards

To remove a host card from your system proceed as follows;

Note

The exact location of host card slots varies for different systems, for exact mechanical details of your system, refer to your system documentation.



Warning

Dangerous voltages exist inside computer systems. Before removing host cards from your system, turn off the power supply and disconnect the mains lead.

1. Turn off the power to your system and disconnect the mains supply.
2. Remove the system cover to expose the inside of the connector panel for host cards.
3. Remove all cables plugged into the host card.
4. Undo the securing screw for the host card you want to remove then lift the card out of its slot as shown in the next picture (ISA card shown).



Caution

Full anti-static precautions should be taken when handling host cards.

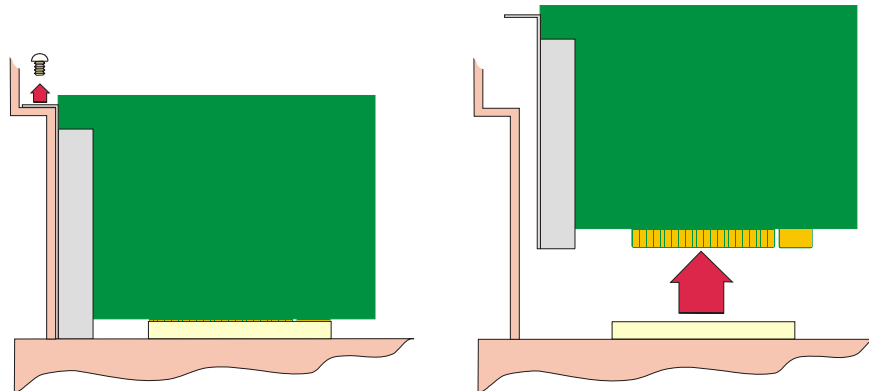

5. Repeat step 4. until you have removed all the host cards you want.
6. Replace and secure the system cover.
7. Plug in the mains lead and turn on the power.

Removal of host cards is now complete. For further details about installation of host cards including other types, see [Before you start](#) on page 18.

Chapter 3 I/O8+ Cabling information

You need to read this chapter if you want to...

You need to read this chapter if you want cabling information for the Perle I/O8+ serial adaptor cards.

This chapter provides cabling and connector pinout information for the Perle I/O8+ serial adaptor cards. Included are details of standard cables for use with I/O8+ products available from Perle.

This chapter includes the following sections;

- [RJ12 socket pinouts on I/O8+ host cards](#) on page **106**
- [I/O8+ cables available from Perle](#) on page **107**

RJ12 socket pinouts on I/O8+ host cards

The connector pinout for each RS232 RJ12 socket fitted to either I/O8+ ISA or PCI host cards is as follows;

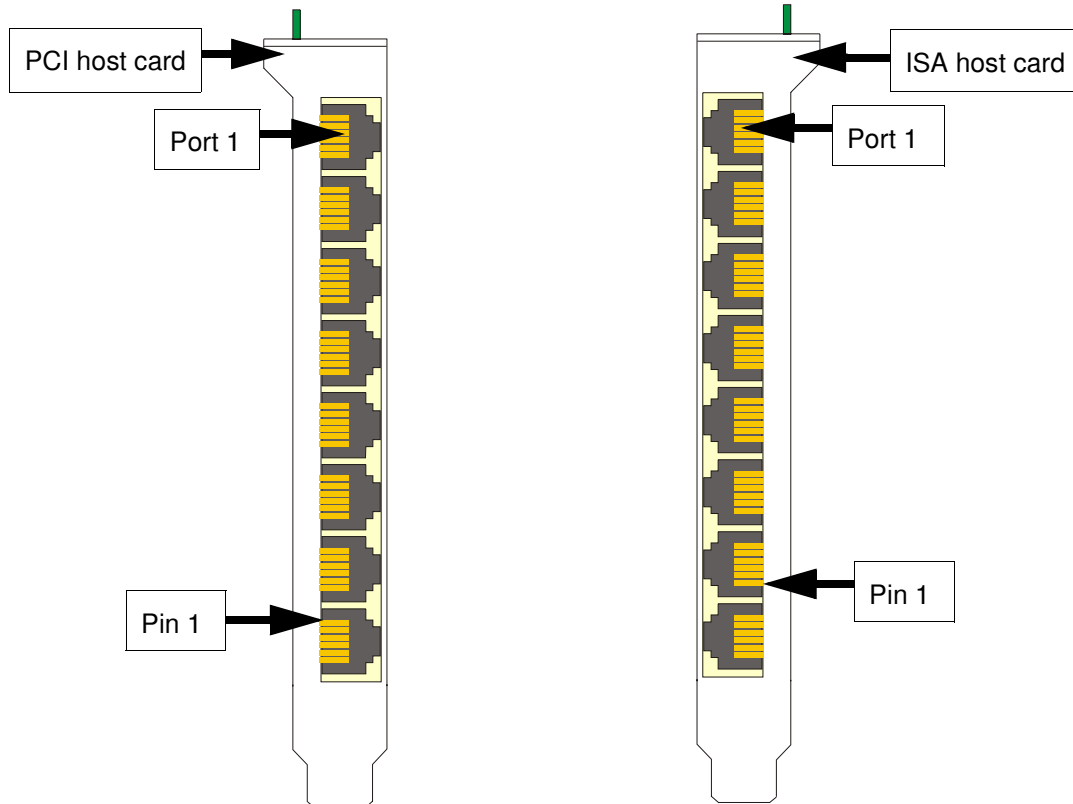

RJ12 pin	Direction	Signal	Description
1	Input	DCD	Data Carrier Detect.
2	Input	RXD	Receive Data.
3	Output	DTR/RTS	Data Terminal Ready/Request To Send. Function depends on the way you open the serial port see page 120 .
4	-	GND	Ground.
5	Output	TXD	Transmit Data.
6	Input	CTS	Clear to send.

I/O8+ cables available from Perle

This section provides connector pinout information for the following standard cables available from Perle:

- [RJ12 to DB9 male cable](#) on page [108](#)
- [RJ12 to DB25 male cable](#) on page [109](#)
- [RJ12 to DB25 female cable](#) on page [110](#).

RJ12 to DB9 male cable

Cable diagram

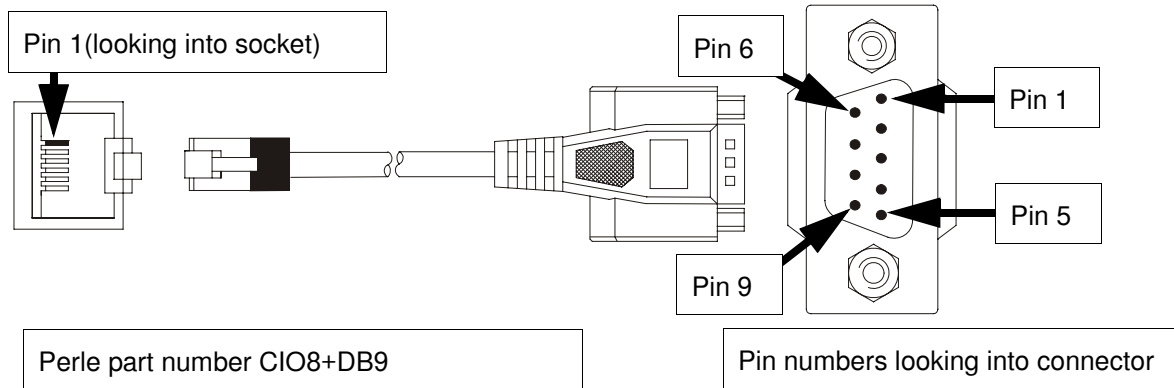

Connector pinout table

RJ12 pin	DB9 Pin	Signal	Description
1	1	DCD	Data Carrier Detect.
2	2	RXD	Receive Data.
3	4 and 7	DTR/RTS	Data Terminal Ready/Request To Send. Function depends on the way you open the serial port see page 120 .
4	5	GND	Ground.
5	3	TXD	Transmit Data.
6	8	CTS	Clear to send.
Shell	Shield	Chassis	Chassis ground.

RJ12 to DB25 male cable

Cable diagram

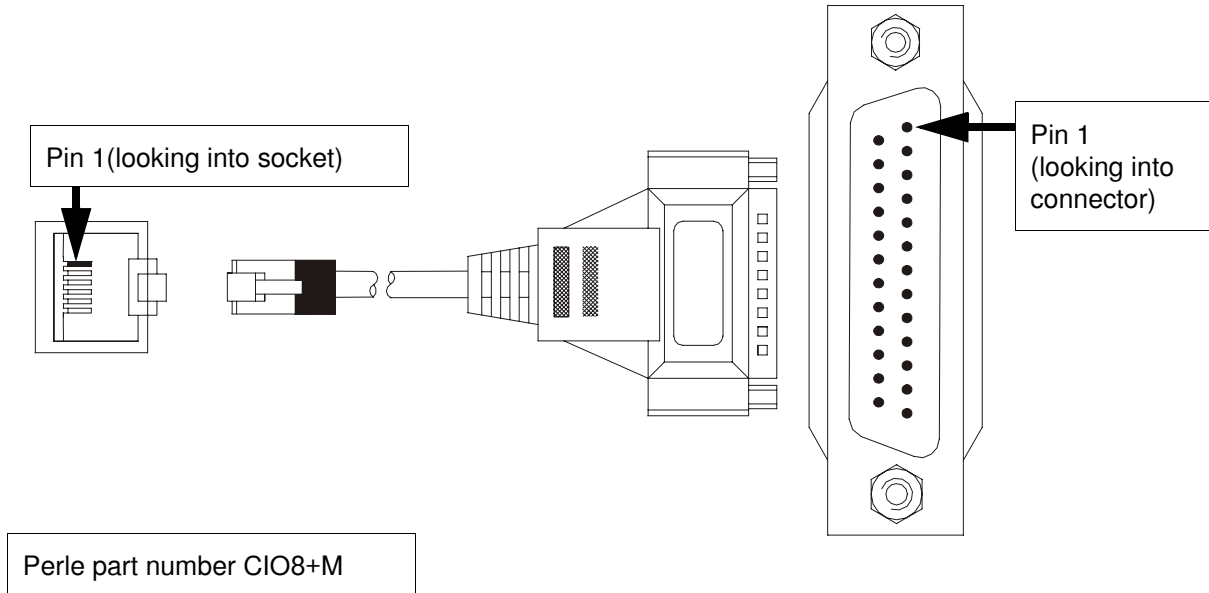

Connector pinout table

RJ12	DB25	Signal	Description
1	8	DCD	Data Carrier Detect.
2	3	RXD	Receive Data.
3	4 and 20	DTR/RTS	Data Terminal Ready/Request To Send. Function depends on the way you open the serial port see page 120 .
4	7	GND	Ground.
5	2	TXD	Transmit Data.
6	5	CTS	Clear to send.
Shield	1 and Shell	Chassis	Chassis ground.

RJ12 to DB25 female cable

Cable diagram

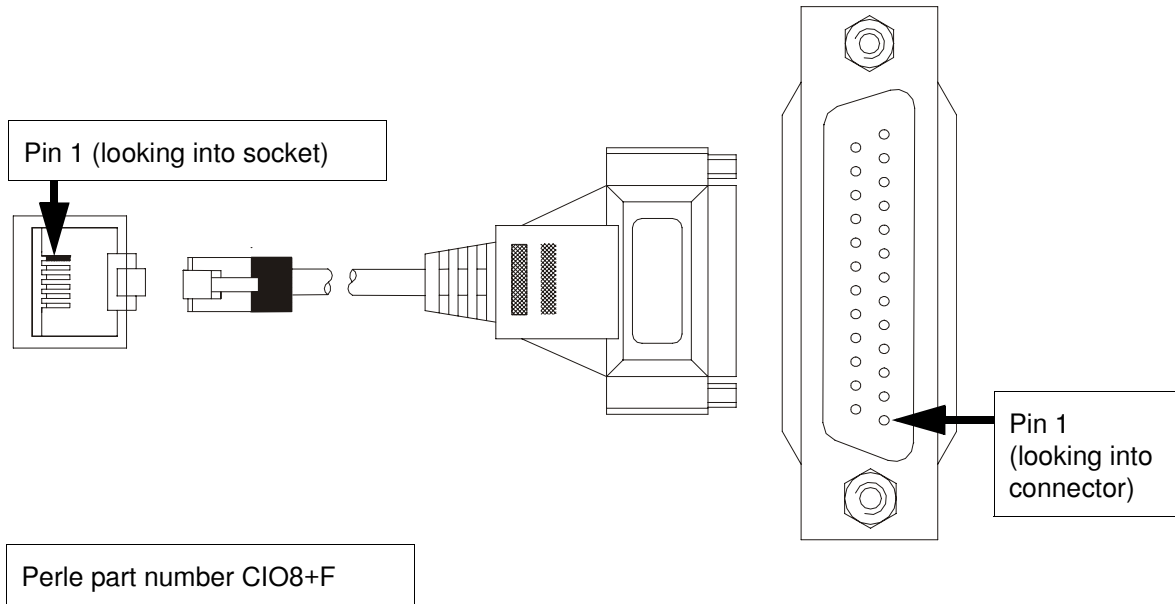

Connector pinout table

RJ12	DB25	Signal	Description
1	8	DCD	Data Carrier Detect.
2	2	RXD	Receive Data.
3	5 and 6	DTR/RTS	Data Terminal Ready/Request To Send. Function depends on the way you open the serial port see page 120 .
4	7	GND	Ground.
5	3	TXD	Transmit Data.
6	4	CTS	Clear to send.
Shield	1 and shell	Chassis	Chassis ground.

Chapter 4 Quick reference

You need to read this chapter if you want to...

You need to read this chapter if you want information in quick reference form about the utilities provided with the I/O8+ Serial adaptor cards.

This chapter provides a quick reference guide to the software utilities provided with the I/O8+ Serial adaptor cards. The utilities are grouped under operating system and include main windows and menus. In addition, cross references are provided for further information about each area.

This chapter includes the following sections;

- [SCO OpenServer utilities](#) on page [112](#)
- [SCO UnixWare utilities](#) on page [116](#)

SCO OpenServer utilities

A number of utilities are provided for use with the SCO OpenServer operating system. See the following sections for information about main windows and menus;

- [Host Card Configuration utility \(SCO OpenServer 5 Only\)](#) on page [113](#)
- [Port Configuration utility](#) on page [114](#)

Host Card Configuration utility (SCO OpenServer 5 Only)

The main window for the Host Card Configuration tool is shown in the next picture. See [Menu map](#) on page 113 for details of menus.

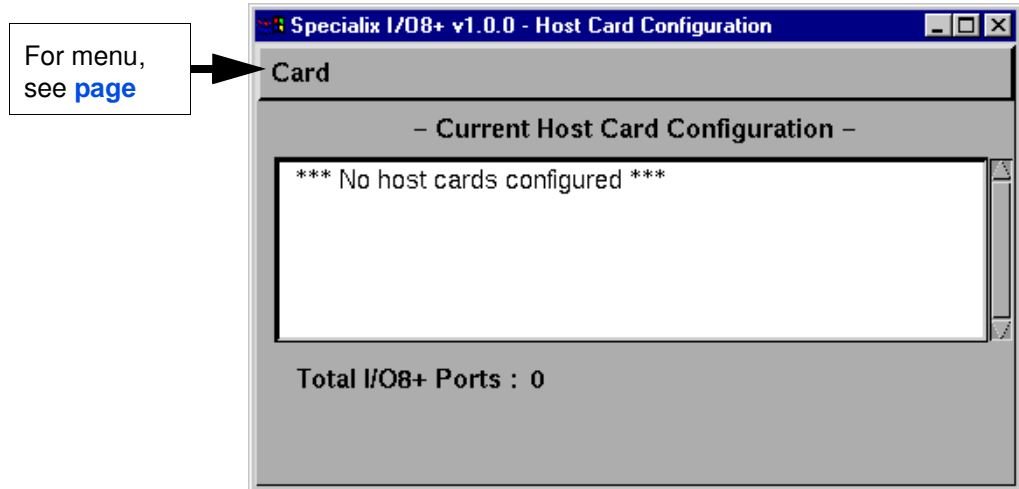

Menu map

The Host Card Configuration tool menu is as follows;

Menu option		Description
Card >	Quit	Quit the Host Card Configuration tool without saving. See page 50 .
	Add	Add a new host card address. See page 45 .
	Remove	Remove a host card address. See page 49 .
	Edit	Edit an existing host card address. See page 47 .
	Save and exit	Exit the Host Card Configuration tool and save any changes. See page 50 .

Port Configuration utility

The main window for the Port Configuration table is shown in the next picture. See [Menu map](#) on page 115 for details of menus.

Specialix I/O8+ Port Configuration

Ports Help

Port	Login	gettydef	Terminal Type	Forced flow control
1		m	unknown	
2		m	unknown	
3		m	unknown	
4		m	unknown	
5		m	unknown	
6		m	unknown	
7		m	unknown	
8		m	unknown	

Available gettydefs

- k
- l
- m**
- n

Terminal type

- tvi925
- unknown**
- vt220
- wspc65

Transparent print flow control : ixon ixany

Login Session :

Callouts:

- Menus see [page 115](#).
- Select one or more ports from this list
- Select a getty definition here. See [page 53](#).
- Select a terminal type here. See [page 53](#)
- Enables or disables flow control. See [page 53](#)
- Enables or disables login. See [page 54](#)

Menu map

The Port Configuration tool menu is as follows;

Menu option		Description
Ports >	Quit	Quit Port Configuration tool without saving changes. See page 54
	Logins	Display all ports with logins enabled. See page 54
	Unconfigured	Display all ports without logins enabled. See page 54
	All	Display all ports. See page 54
	Save & Exit	Exit the Port Configuration tool and save changes. See page 54

SCO UnixWare utilities

Device configuration utility

The main window for the Device Configuration Utility is shown in the next picture.

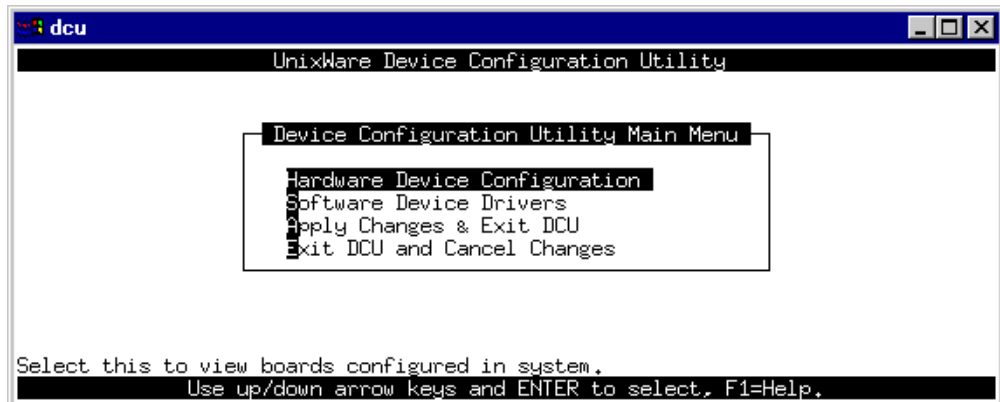

Menu map

The menu is as follows;

Menu option	Description
Hardware Device Configuration >	Displays the Hardware Device Configuration window which allows you to set host card addresses and IRQ levels. See page 64 .
Software Device Drivers >	Displays the Software Driver Device selections window which allows you to select a software device driver type to display. See page 71 .
Apply Changes & Exit DCU >	Apply configuration changes and exit the Hardware Device Configuration Utility. See page 72 .
Exit DCU and Cancel Changes >	Exit the Hardware Device Configuration Utility and cancel any changes. See page 72 .

Serial Manager

Main window The main window for the Serial Manager is shown in the next picture. You can display this window in one of two views, Board view and Ports view. See [page 118](#) for menu maps.

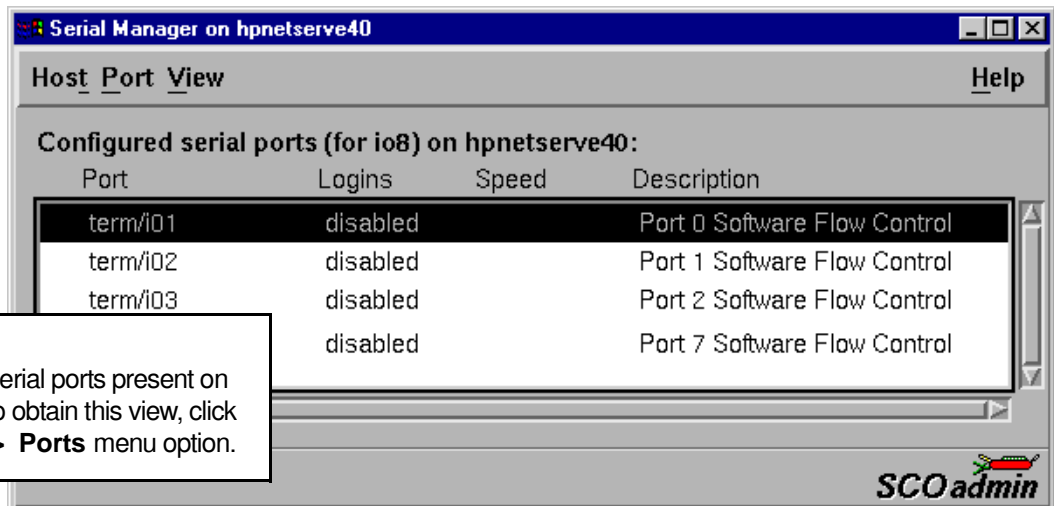
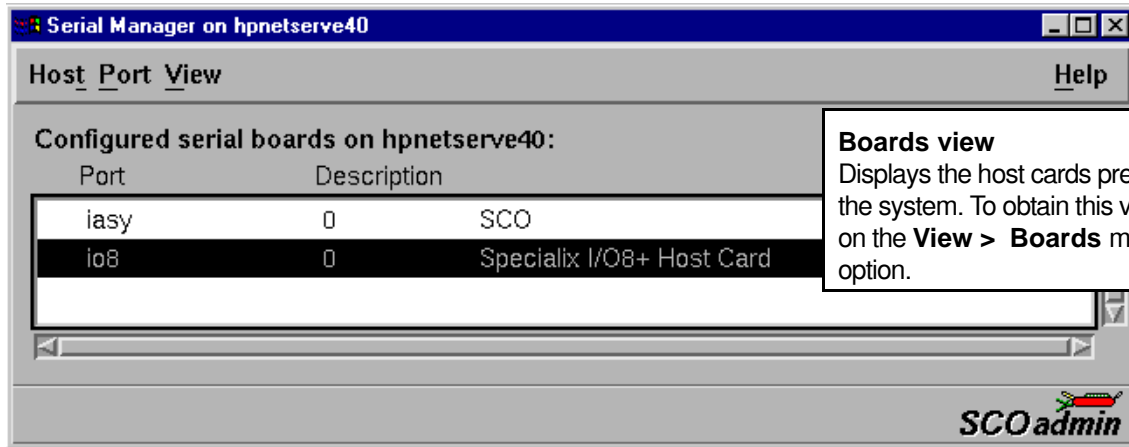

Menu map

The Serial Manager menu is as follows;

Menu option		Description
Host >	Open Host	Selects a host machine. See your SCO UnixWare documentation for further details.
	Exit	Exit Serial Manager.
Port >	Modify	Modifies serial port settings. See page 73 .
View >	Ports	Show serial ports available for the currently selected host card. See page 73 .
	Boards	Show host cards present on the system. See page 73 .

Appendix A Serial port device names

You need to read this appendix if you want information about device names for the Perle I/O8+ serial adaptor cards.

This appendix provides information about the device nodes associated with each serial port for the Perle I/O8+ serial adaptor cards. Included are naming conventions, functions, file locations and some additional information about the Data terminal ready and Ready to send signals.

This chapter includes the following sections;

- [Under SCO OpenServer](#) on page [120](#)
- [Under SCO UnixWare](#) on page [121](#)

Under SCO OpenServer

Device node details

Each serial port has three device nodes associated with it. Each node takes the form of a file which you can access from operating system utilities and user applications. Details of these nodes are shown in the next table.

Device name	Function	Description	Location
ttyi1	Normal communications port	Indicates normal communications port behaviour.	/dev
ttyl1	Normal communications port wait for DCD on open	Indicates a port open will not complete unless the DCD signal is present.	/dev
ttyi1p	Print device	Indicates that device should only be used for transparent print.	/dev

DTR and RTS signal information

The serial ports on I/O8+ serial adaptor cards use the same pin (pin3 on the RJ12 connector see [Chapter 3 I/O8+ Cabling information](#)) for the **Data Terminal Ready** and **Ready To Send** signals. The function of the pin depends on the way you open the port as shown in the next table.

Device name	Function	Signal	Description
ttyi1	Normal communications port.	RTS	Ready To Send . Used for hardware flow control.
ttyl1	Normal communications port wait for DCD on open.	DTR	Data Terminal Ready . This pin cannot be used for hardware flow control when this type of device is opened.

Under SCO UnixWare

Device node details

Each serial port has three device nodes associated with it. Each node takes the form of a file which you can access from operating system utilities and user applications. Details of these nodes are shown in the next table.

Device name	Function	Description	Location
ix	Normal communications port	Indicates normal communications port behaviour.	/dev/term
lx	Modem port	Indicates a port open will not complete unless the DCD signal is present.	/dev/term
ixp	Transparent print ports	Indicates that device should only be used for transparent print.	/dev/term

Note

x denotes a physical port on a host card.

When x is between 1 and 9, it is written as 0x.

You can only open the transparent print port can when the corresponding normal port is open.

Appendix B Transparent printing

You need to read this appendix if you want to... You need to read this appendix if you want background information on transparent printing. This appendix gives an overview of the transparent printing feature offered for the SCO OpenServer and SCO UnixWare operating systems and includes details of configuration files associated with transparent printing.

This appendix includes the following sections;

- [What is transparent printing?](#) on page **123**
- [Problems with printer output](#) on page **124**
- [The printcap.io8 configuration file](#) on page **124**
- [The print.io8 configuration file](#) on page **125**

What is transparent printing?

Most terminals have an auxiliary (AUX) port which can be connected to a serial printer. Data can then be output to the terminal or the printer via the same serial line. This is called **transparent print** (or xprint) and is designed for printing simple ascii text. A separate xprint device node (`ttyinp` where `n` is device number) is created for each port. This device is enabled automatically if either the local or modem device is enabled for the port.

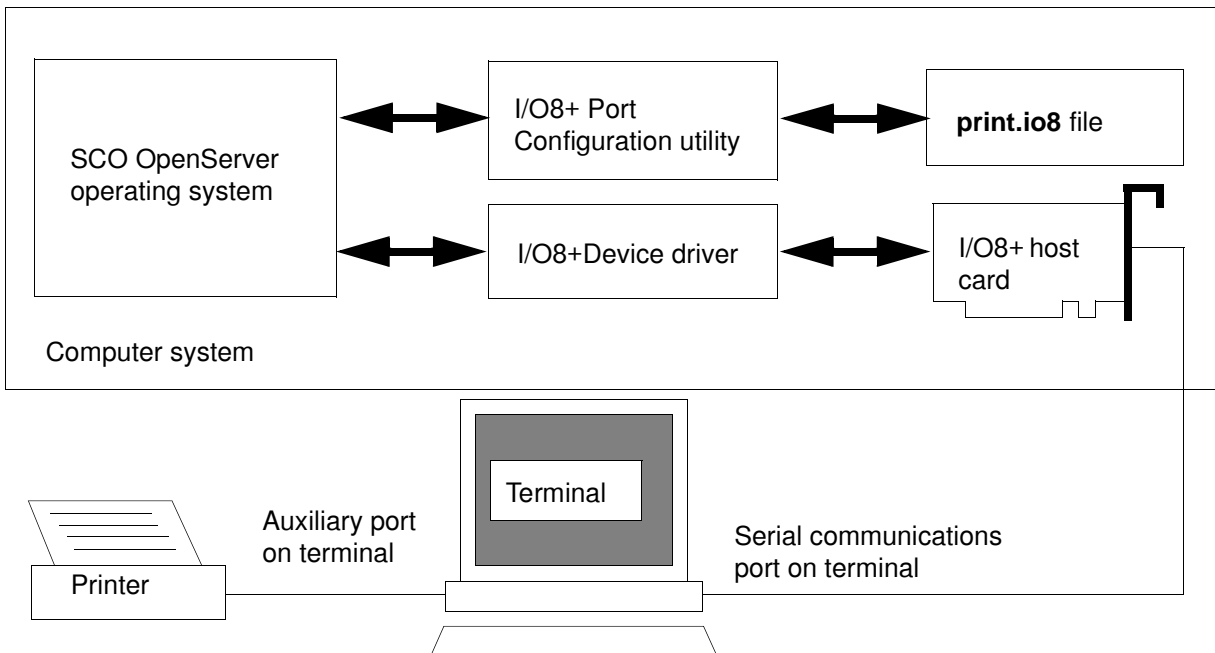

When a host card receives data addressed to the transparent print device it prefixes it with the transparent print mode ON string and appends it with the transparent mode OFF string. The ON and OFF strings for each terminal type available are defined by the **printcap.io8** file. See [The printcap.io8 configuration file](#) on page 124 for more details.

When the host card receives data addressed to the transparent print device, it prefixes it with the Transparent Print Mode ON string and appends it with the Transparent Print Mode OFF string. Terminal I/O has absolute priority over printer output. Transparent print data will only be sent when there is a break in output to the terminal (for more than a tenth of a second)

For each port, the transparent printing parameters are controlled by an entry in the **print.io8** file found in the `/etc/` directory on your system. The entry for each port includes definitions of the terminal type, transparent print throughput rate and device name. See [The print.io8 configuration file](#) on page 125 for further details.

Problems with printer output

When you use transparent printing you may obtain incorrect printer output due to the following reasons;

Graphics printers may misinterpret some characters output through transparent print. This problem is more likely if the terminal is in 7-bit mode, because 8-bit characters will not be printed.

Some terminals suppress the output of certain characters to their printer or AUX ports. Such terminals can prevent essential control characters from reaching the printer thus generating incorrect printer output. This occurrence is extremely unpredictable because of the large number of potential hardware configurations.

The `printcap.io8` configuration file

The `printcap.io8` file defines the transparent print ON and OFF strings for each terminal type available. When a host card receives data addressed to the transparent print device it prefixes it with the transparent print mode ON string and appends it with the transparent mode OFF string.

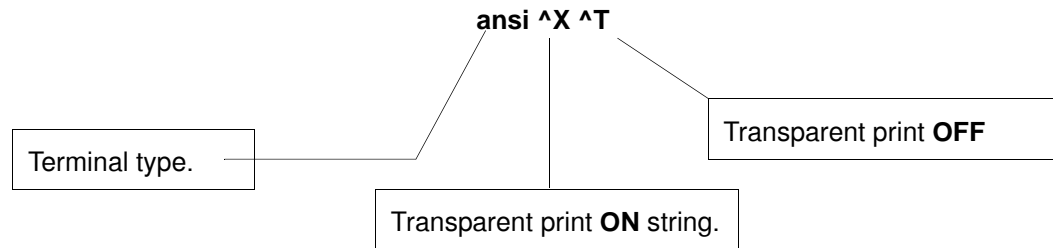

If you don't configure a specific terminal type `printcap.io8` will use the default type which is "unknown"

The print.io8 configuration file

For each port, transparent printing is controlled by an entry in the **print.io8** file. The **print.io8** file is found in the /etc/ directory on your system. The entry for each port includes definitions of the terminal type, transparent print throughput rate, device name. The content of the **print.io8** file is normally controlled automatically by either the Port Configuration utility (SCO OpenServer) or the Serial Manager (SCO UnixWare). A sample entry from a typical print.io8 file is shown in the next example.

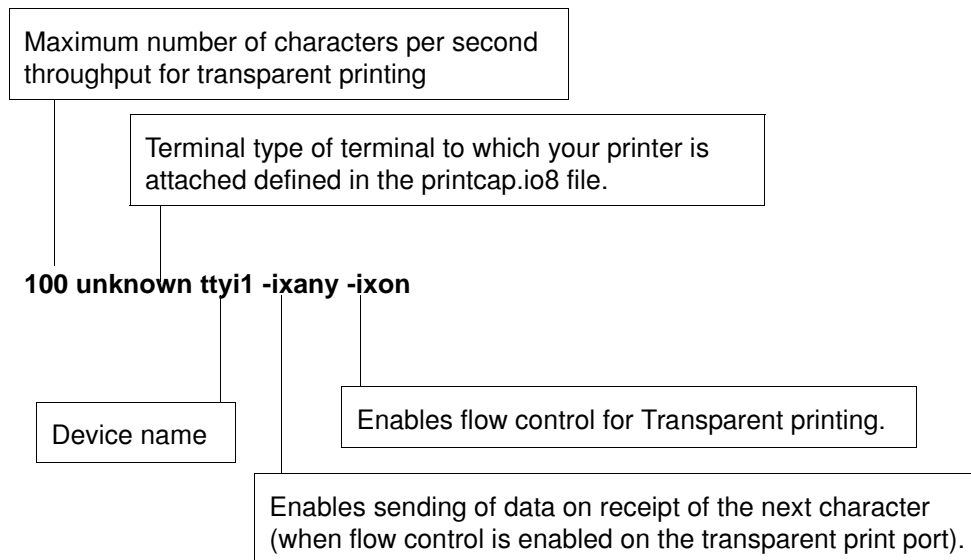

Appendix C ISA host card address settings

You need to read this appendix if you want to... You need to read this appendix if you want information on converting hexadecimal addresses into binary for I/O8+ ISA serial adaptor cards.

This appendix provides a table for converting hexadecimal addresses into binary for I/O8+ ISA serial adaptor cards. See also [Installing an ISA host card](#) on page 101 in [Chapter 2 Installing drivers and host cards](#).

This appendix includes the following sections;

- [DIL switch location](#) on page 127
- [Hexidecimal to binary conversion table](#) on page 128.

DIL switch location

You assign host card addresses for an ISA host card using the on board configuration DIL switch on an I/O8+ ISA host card (shown in the next picture). To convert I/O8+ hexadecimal address into binary see [Hexidecimal to binary conversion table](#) on page 128.

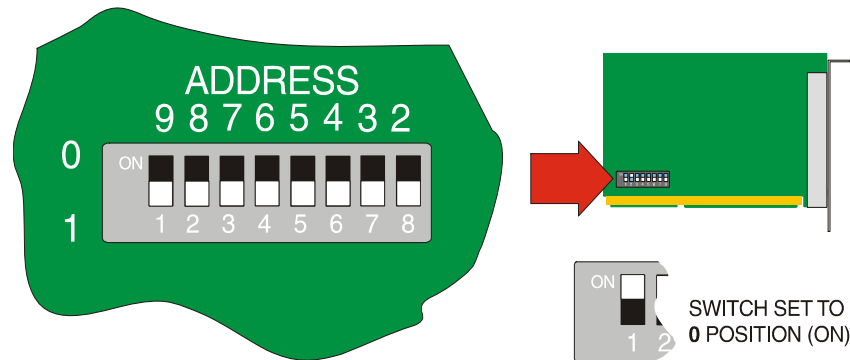

See also [Installing an ISA host card](#) on page 101 in [Chapter 2 Installing drivers and host cards](#).

Hexidecimal to binary conversion table

This table tells you how to convert hexadecimal addresses into binary for I/O8+ ISA host cards. You use the resulting values to assign host card addresses using the on board configuration DIL switch on an I/O8+ ISA host card (see [DIL switch location](#) on page 127).

Host card address	Switch setting on host card	Host card address	Switch setting on host card	Host card address	Switch setting on host card
100	01000000	170	01011100	1e0	01111000
104	01000001	174	01011101	1e4	01111001
108	01000010	178	01011110	1e8	01111010
10c	01000011	17c	01011111	1ec	01111011
110	01000100	180	01100000	1f0	01111100
114	01000101	184	01100001	1f4	01111101
118	01000110	188	01100010	1f8	01111110
11c	01000111	18c	01100011	1fc	01111111
120	01001000	190	01100100	200	10000000
124	01001001	194	01100101	204	10000001
128	01001010	198	01100110	208	10000010
12c	01001011	19c	01100111	20c	10000011
130	01001100	1a0	01101000	210	10000100
134	01001101	1a4	01101001	214	10000101
138	01001110	1a8	01101010	218	10000110
13c	01001111	1ac	01101011	21c	10000111
140	01010000	1b0	01101100	220	10001000
144	01010001	1b4	01101101	224	10001001
148	01010010	1b8	01101110	228	10001010
14c	01010011	1bc	01101111	22c	10001011
150	01010100	1c0	01110000	230	10001100
154	01010101	1c4	01110001	234	10001101
158	01010110	1c8	01110010	238	10001110
15c	01010111	1cc	01110011	23c	10001111
160	01011000	1d0	01110100	240	10010000
164	01011001	1d4	01110101	244	10010001
168	01011010	1d8	01110110	248	10010010
16c	01011011	1dc	01110111	24c	10010011

Host card address	Switch setting on host card	Host card address	Switch setting on host card	Host card address	Switch setting on host card
250	10010100	2d0	10110100	350	11010100
254	10010101	2d4	10110101	354	11010101
258	10010110	2d8	10110110	358	11010110
25c	10010111	2dc	10110111	35c	11010111
260	10011000	2e0	10111000	360	11011000
264	10011001	2e4	10111001	364	11011001
268	10011010	2e8	10111010	368	11011010
26c	10011011	2ec	10111011	36c	11011011
270	10011100	2f0	10111100	370	11011100
274	10011101	2f4	10111101	374	11011101
278	10011110	2f8	10111110	378	11011110
27c	10011111	2fc	10111111	37c	11011111
280	10100000	300	11000000	380	11100000
284	10100001	304	11000001	384	11100001
288	10100010	308	11000010	388	11100010
28c	10100011	30c	11000011	38c	11100011
290	10100100	310	11000100	390	11100100
294	10100101	314	11000101	394	11100101
298	10100110	318	11000110	398	11100110
29c	10100111	31c	11000111	39c	11100111
2a0	10101000	320	11001000	3a0	11101000
2a4	10101001	324	11001001	3a4	11101001
2a8	10101010	328	11001010	3a8	11101010
2ac	10101011	32c	11001011	3ac	11101011
2b0	10101100	330	11001100	3b0	11101100
2b4	10101101	334	11001101	3b4	11101101
2b8	10101110	338	11001110	3b8	11101110
2bc	10101111	33c	11001111	3bc	11101111
2c0	10110000	340	11010000	3c0	11110000
2c4	10110001	344	11010001	3c4	11110001
2c8	10110010	348	11010010	3c8	11110010
2cc	10110011	34c	11010011	3cc	11110011

Host card address	Switch setting on host card	Host card address	Switch setting on host card	Host card address	Switch setting on host card
3d0	11110100	3e0	11111000	3f0	11111100
3d4	11110101	3e4	11111001	3f4	11111101
3d8	11110110	3e8	11111010	3f8	11111110
3dc	11110111	3ec	11111011	3fc	11111111

Appendix D Troubleshooting

You need to read this appendix if you want to read information on troubleshooting error messages experienced with I/O8+ serial adaptor cards.

This appendix provides examples of normal boot up messages and a table of error messages, their meaning and corrective action required for the all the currently supported operating systems.

This appendix includes the following sections;

- [Windows 95 and 98](#) on page [132](#)
- [Windows NT](#) on page [140](#)
- [SCO OpenServer 5](#) on page [141](#)
- [SCO UnixWare/SCO OpenServer 6](#) on page [143](#).
- [Windows 2000/XP/Server 2003/Vista/Server 2008](#) on page [146](#)

Windows 95 and 98

Resource conflicts

If the system cannot use the factory default or allocate free resources when the system tries to add the ISA card at its default address and IRQ level the following message screen is displayed.



If this occurs proceed as follows;

1. In the Add New Hardware Wizard, click on the **Next >** button to display the following screen.



2. In the Add New Hardware Wizard, click on the **Finish** button.
The Properties tabbed window is now displayed.
3. In the properties tabbed window, click on the **Resources** tab.
The **Resources** page is now displayed.



4. In the Resources page, click on the **Set Configuration Manually** button

The lower half of the Resources page is now updated to show the resources currently in use as shown in the next picture.

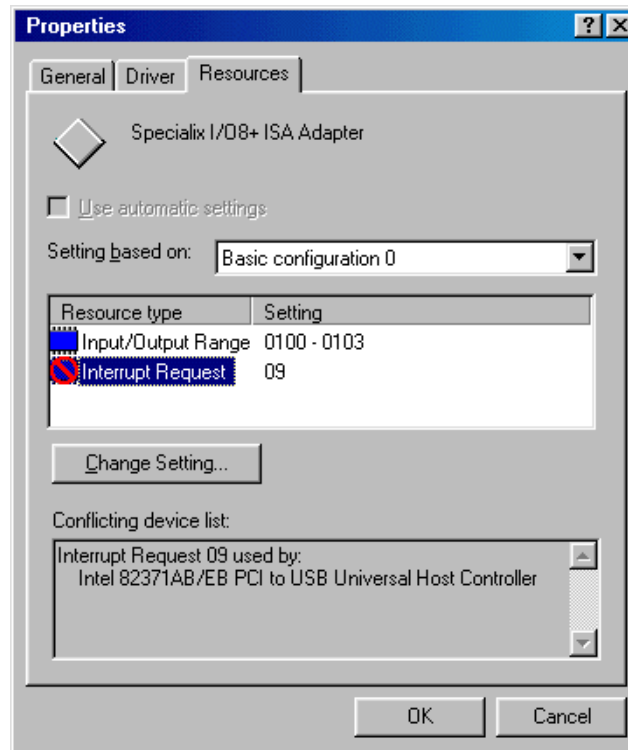

5. Note the details of the resource conflict down, then in the Resources page, click on **Change Setting** button,

The Edit Interrupt Request window is now displayed.

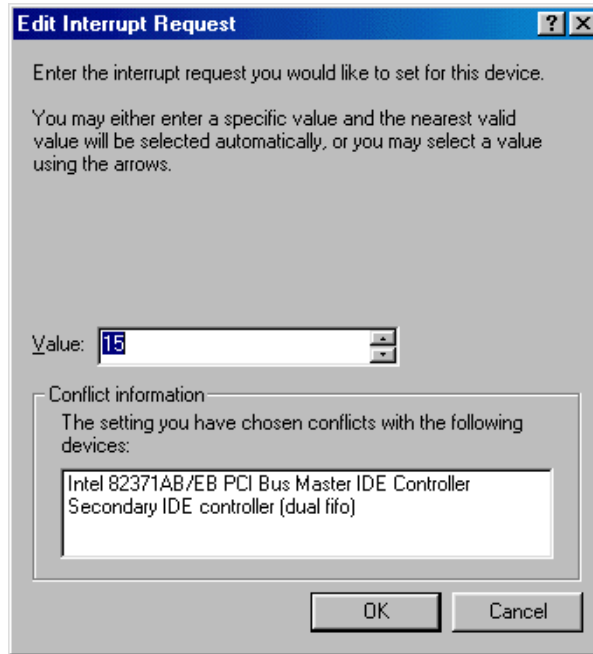

6. In the Edit Interrupt Request window, Scroll through the different Interrupt Request levels using the **Value** field selector to establish if there are any Request Levels you can reallocate.
7. Once you have established a device whose resources can be reallocated, try re-allocating system resources using the methods suggested in [Re-allocating system resources](#) on page [136](#).

Re-allocating system resources

Having found another IRQ level you can allocate (typically from another ISA card) you can re-allocate resources in one of the following ways;

- [Re-allocating resources from the BIOS](#) on page [136](#)
- [Re-allocating resources using Device Manager](#) on page [137](#)

Re-allocating resources from the BIOS

To re-allocate resources from with the BIOS proceed as follows;

- Go into the system BIOS and reserve the Interrupt Request Level you want to use.

Any PCI devices present on the system should now use a different IRQ level automatically. The resource you have reserved should now be free on re-starting your system.

Note

If you want to use the IRQ level from another ISA device, you can't do this from within the BIOS. In this case you will need to use the Device Manager Facility. See [Re-allocating resources using Device Manager](#) on page [137](#) for details.

Re-allocating resources using Device Manager

If you are unable to re-allocate resources from with the system BIOS, you can try using the Device Manager instead using the following procedure;

1. In the Windows desktop, click on the **Start** button and select **Settings > Control Panel** to display the Control panel window.
2. In the Control panel window, double click on the System icon shown in the next picture.



3. In the System Properties tabbed window now displayed, click on the **Device Manager** tab to display the Device manager page.

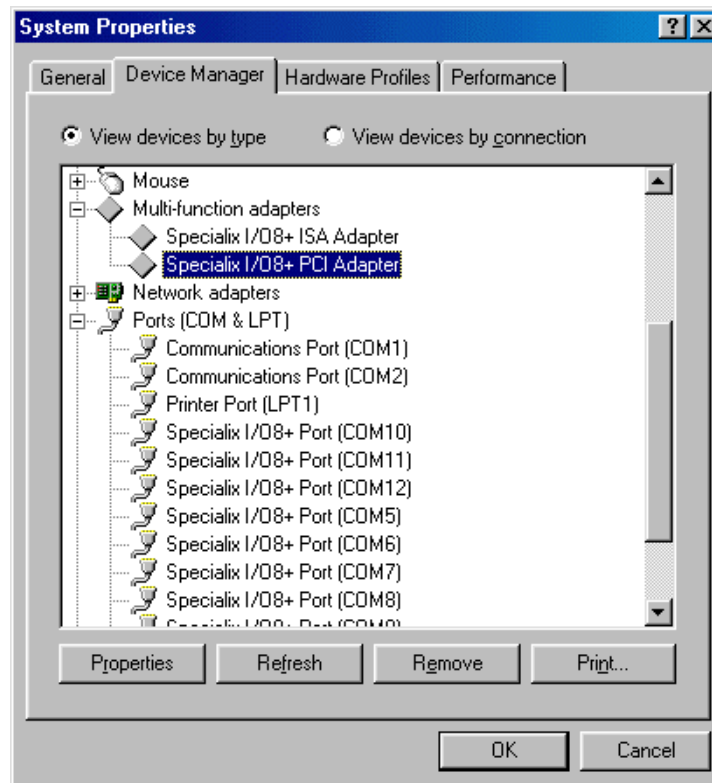

4. In the device manager page, double click on the device which is currently using the IRQ level you want.

5. In the properties tabbed window now displayed, click on the **Resources** tab.
The **Resources** page is now displayed as shown in the next picture.

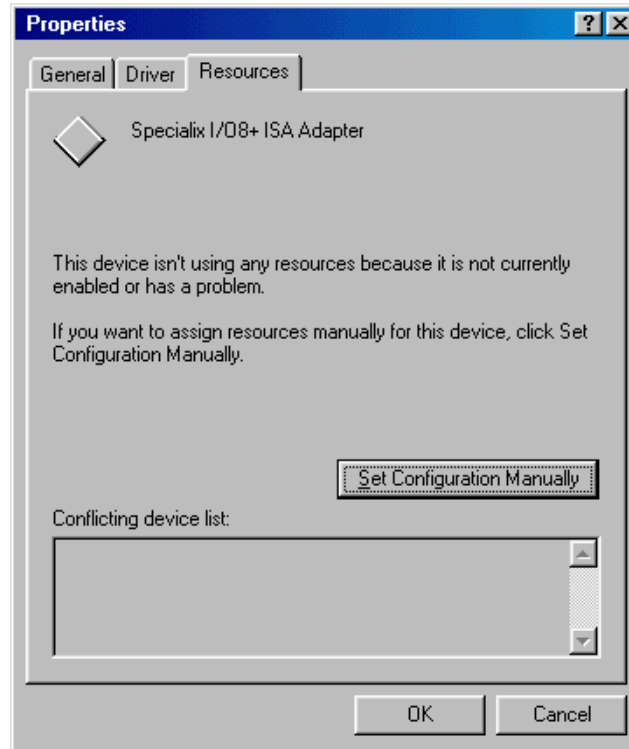

- In the Resources page, click on the **Set Configuration Manually** button

The lower half of the Resources page is now updated to show the resources currently in use as shown in the next picture.

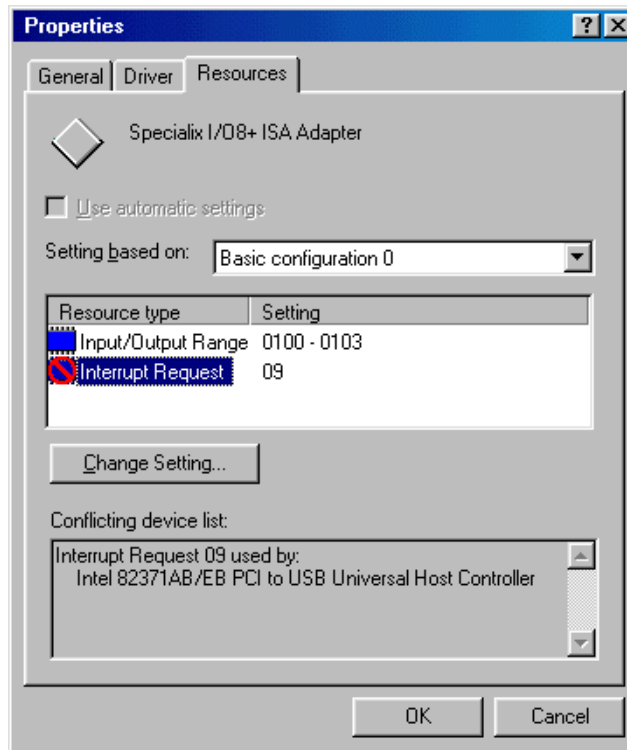

- In the Resources page, change the resource property of the device to free up the resource you want. Refer to your Windows documentation for further details.

Windows NT

Windows NT general troubleshooting

In the event of any problems, open the **Devices** window to view the status of any installed hardware. For further details of troubleshooting under Windows NT, see your Windows NT user documentation or help system.

SCO OpenServer 5

Example of normal boot up messages for host cards

The normal messages for satisfactory host card detection and initialisation form part of the normal SCO OpenServer 5 boot up messages and are shown in the next example. This example shows one ISA host card and one PCI host card.

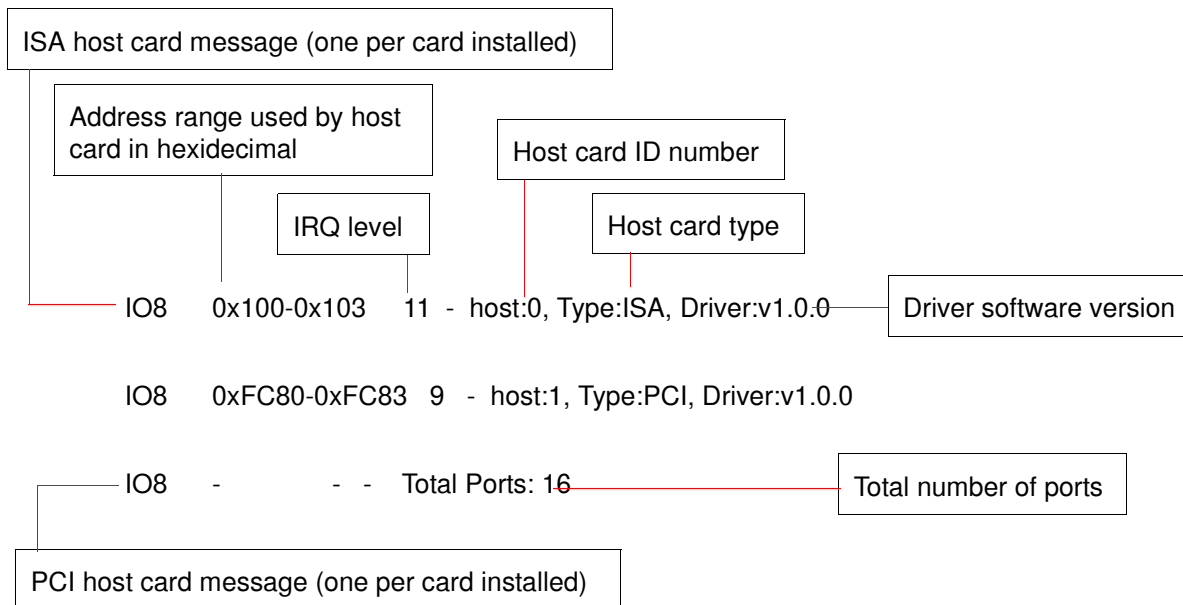

Error messages

Error message	Reason	Action required
ERROR: a PCI host is not initialised	PCI host card faulty.	<ol style="list-style-type: none"> 1. Ensure that you have followed the installation procedure correctly. See page 17 2. If the problem persists try another host card. See page 17.
ERROR: an ISA host is not initialised	Driver software has been unable to detect an ISA host card at the specified address.	<ol style="list-style-type: none"> 1. Check that DIL switch settings on host cards match those set in Host Card Configuration tool. See page 47. 2. Ensure that you have followed the installation procedure correctly. See page 17. 3. If the problem persists try another host card. See page 17.
ERROR: a PCI host has bad resource(s)	PCI host card faulty.	<ol style="list-style-type: none"> 1. Ensure that you have followed the installation procedure correctly. See page 17 2. If the problem persists try another host card. See page 17.
ERROR: an ISA host has bad resource(s)	Duplication of addresses and/or IRQ level for two or more host cards.	<ol style="list-style-type: none"> 1. Check that DIL switch settings on host cards match those set in Host Card Configuration tool. See page 47. 2. Ensure that you have followed the installation procedure correctly. See page 17. 3. If the problem persists try another host card. See page 17.
WARNING: a PCI host is not configured	System error.	<ol style="list-style-type: none"> 1. Remove the I/O8+ host card and uninstall the drivers from your system. See page 17 and page 55. 2. Re-install the drivers and host cards onto your system taking care to follow the correct procedure. See page 17.
WARNING: an ISA host is not configured		
Serial port device node related messages	Serial port device nodes not present.	<ol style="list-style-type: none"> 1. Invoke the io8hcfg utility. See page 43. 2. Ensure all installed host cards are listed. 3. Save and exit the utility to create the device nodes.

SCO UnixWare/SCO OpenServer 6

Example of normal boot up messages for host cards

The normal messages for satisfactory host card detection and initialisation form part of the normal SCO UnixWare boot up messages and are shown in the next example. This example shows one ISA host card and one PCI host card.

SCO UnixWare

IO8 UnixWare Driver v1.0.0

I/O8+ Host Card Type ISA Interrupt 11
I/O8+ Host Card Type PCI Interrupt 9

host card message
(one per card installed)

Host card type

IRQ level

SCO OpenServer 6

Perle IO8+ OpenServer 6 Driver v1.0.0

Copyright (c) Perle Systems Limited, Jan 25, 2006, 17:57:59

I/O8+: PCI Card at Interrupt 9

host card message
(one per card installed)

Host card type

IRQ level

Error messages

I/O8+ host card error messages

Error message	Reason	Action required
No I/O 8+ hosts located within system	I/O8+ driver was unable to find any I/O8+ Host Cards.	Ensure that you have inserted each I/O8+ host card into its slot properly. See page 100 and page 100 .
io8_ : No Card slot found	I/O8+ driver was unable to determine in which slot the host card is located.	Try installing the host card in a different position. See page 100 and page 100 .
io8_ : Address not found	I/O8+ driver failed to Read the address.	For ISA host cards, ensure you have assigned the addresses correctly. See page 64 . For PCI host cards, ensure that the Device Configuration Utility displays a valid address for the card. See page 71 .
io8_ : Card not ready. GSVR x, wait y	The I/O8+ host card is not responding to commands and may be faulty.	Try installing another host card. See page 57 .
io8_ : Wrong IDENT	I/O8+ driver does not recognise a card as an I/O8+ host card. Host card may be faulty.	Try installing another host card. See page 57 .
io8_ : No Interrupt number found	The I/O8+ driver was unable to read the interrupt number from the operating system.	For ISA cards, ensure the correct interrupt has been set on the card and that the correct value has been set with the Device Configuration Utility. See page 64 and page 71 . For PCI host cards, ensure that the Device Configuration Utility has selected a valid interrupt. See page 71 .
io8_ : Fail attach Interrupt	The I/O8+ driver failed to attach an interrupt.	Check that the interrupt set by the Device Configuration Utility is valid for the I/O8+ card and not used by another application. See page 71 .

I/O8+ software error messages

The following messages are caused by applications which use the I/O8+ serial ports such as terminals.

Error message	Reason	Action required
io8_ : real port not open	An application has attempted to open a Transparent port without the real port being open.	Ensure your application opens a real port before opening the transparent port.
io8_ : open fails - modem + local at same time	An application cannot open a particular port as Local and Modem simultaneously.	Ensure your application only uses each port as either a local or a modem but not both .
io8_ :open fails - exclusive use set	An application cannot open a particular port while it is already open.	Ensure your application closes any ports already in use before starting.
io8_ : Cannot close : X Print still open	An application cannot close the local port while the transparent print port remains open.	Ensure your application closes the transparent port when appropriate.

Windows 2000/XP/Server 2003/Vista/Server 2008

This section describes troubleshooting I/O8+ products under the Windows 2000/XP/Server 2003/Vista/Server 2008 operating systems and includes the following sections:

Note

To contact Perle for technical support, see [Appendix E Contacting Perle](#).

- [General troubleshooting under Windows 2000/XP/Server 2003/Vista/Server 2008](#) on page [147](#)
- [Windows 2000/XP/Server 2003/Vista/Server 2008 error messages](#) on page [148](#).

General troubleshooting under Windows 2000/XP/Server 2003/Vista/Server 2008

Problem	Action required
Machine fails to boot.	<ol style="list-style-type: none"> 1. Turn off your machine, remove I/O8+ card(s) and reboot. See page 103. 2. In the BIOS setup, make sure memory and interrupts levels are reserved for any ISA cards fitted. 3. Check the memory address switch settings on any ISA cards fitted. See page 101. 4. Try installing a different host card in case the one currently installed is faulty. See page 101.
Windows operating system fails while loading and the system hangs.	<ol style="list-style-type: none"> 1. Reboot machine and then switch to the last known good configuration. 2. Check for resource conflicts or faulty hardware. 3. Turn off machine, remove any I/O8+ cards fitted (page 103) and then reboot your system. 4. Once the machine boots properly, change the configuration settings of the I/O8+ card to match those in the BIOS setup. See page 101.
Windows operating system fails while loading and displays a blue screen.	<ol style="list-style-type: none"> 1. Note the five hexadecimal numbers at the top line of the screen 2. Reboot your machine and then switch to the last known good configuration. 3. Check for resource conflicts or faulty hardware. 4. Turn off machine, remove any I/O8+ cards fitted (page 103) and then reboot your system. 5. Once the machine boots properly, change the configuration settings of the I/O8+ card to match those in the BIOS setup. See page 101.
Operating system loads OK, but I/O8+ driver or another driver fails to boot.	<ol style="list-style-type: none"> 1. Run Windows Device Manager to find available IRQ and memory addresses.
I/O8+ ports do not work after installation.	<ol style="list-style-type: none"> 1. Check the Windows Event Log and follow the suggested actions.

Problem	Action required
Windows driver fails during normal operation, symptom: blue screen.	<ol style="list-style-type: none"> 1. Note the five hexadecimal numbers displayed at the top line of the screen. 2. Reboot your machine and then switch to the last known good configuration. 3. Check for resource conflicts or faulty hardware. 4. Turn off machine, remove any I/O8+ cards fitted (page 103) and then reboot your system. 5. Once the machine boots properly, change the configuration settings of the I/O8+ card to match those in the BIOS setup. See page 101.
Windows driver fails during normal operation, symptoms either: black screen, machine reboots or system hangs.	<ol style="list-style-type: none"> 1. Contact Technical Support. See Appendix E Contacting Perle.

Windows 2000/XP/Server 2003/Vista/Server 2008 error messages

In the event of any error messages, check the Windows **Event Log**. Also open the Windows Device Manager and check for warning icons on the installed hardware. See your Windows user documentation or help system for details.

For general problems, see [General troubleshooting under Windows 2000/XP/Server 2003/Vista/Server 2008](#) on page 147.

Appendix D Contacting Perle

You need to read this appendix if you want to... You need to read this appendix if you want to contact Perle for technical support or any other queries about this product.

This appendix includes the following sections;

- [Making a technical Support Query](#) on page 109
- [Repair procedure](#) on page 112
- [Feedback about this manual](#) on page 112
- [Contacting Perle technical support](#) on page 113

Internet access

[Click here to access the our website at the following URL:](#)
<http://www.perle.com>

Email

[Click here to email](#) Perle at the following address;
Email: ptac@perle.com

Making a technical Support Query

This section contains the following information about making a query;

- [Who to contact](#) on page [109](#)
- [Information needed when making a query](#) on page [110](#)
- [Making a support query via the Perle web page](#) on page [111](#)

Who to contact

If you bought your product from a registered Perle supplier, you must contact their Technical Support department; they are qualified to deal with your problem.

If you are a registered Perle supplier, and bought your product from Perle, contact Perle Technical Support using the details given in [Contacting Perle technical support](#) on page [113](#).

Information needed when making a query

When you make a technical support enquiry please have the following information ready;

Hint

Print out this page and fill in the table provided with the basic information you need.

Item	Write details here
Product name and version	
Problem description	
Operating system version	
Driver version	
Details of any other cards installed in your system	
Your name	
Company Name	
Country	
Phone number	
Fax number	
Email address (if available)	

Making a support query via the Perle web page

If you have an internet connection, please send details of your problem to Technical Support using the email links provided on the Perle web site in the 'Support' area.

See also [Contacting Perle technical support](#) on page 113 for email links and other contact details for the Perle technical support centres.

[Click here to access our website at the following URL:
http://www.perle.com](http://www.perle.com)

Repair procedure

Before sending a unit for repair, you must contact your Perle supplier. If, however, you bought your product directly from Perle you can contact directly. See [Contacting Perle technical support](#) on page 113 for contact information.

Customers who are in Europe, Africa or Middle East can submit repair details via a website form shown in the next picture. This form is on the Perle website, www.perle.com, in the **Support** area.

Click here to access our web site at the following URL:
http://www.perle.com/support_services/rma_form.asp

In the USA and Asia contact the office shown in the Technical Support section.

Feedback about this manual

If you have any comments or suggestions for improving this manual please email Perle using the following address;

Email: ptac@perle.com

Please include the **title**, **part number** and **date** of the manual (you can find these on the title page at the front of this manual).

Contacting Perle technical support

Note

Perle offers free technical support to Perle Authorised Distributors and Registered Perle Resellers.

To access technical support please visit the Perle website at www.perle.com/support_services/index.shtml.

If you are unable to find the information you require, please feel free to contact our technical support teams by email using the addresses shown in the next table.

Region	Address	Email
North America	Perle Systems Ltd. 60 Renfrew Drive Markham Ontario Canada L3R OE1	Email: ptac@perle.com
Europe	Perle Systems Europe Ltd. 3 Wintersells Road Byfleet Surrey KT14 7LF UK	Email: ptac@perle.com
Asia	Perle Asia Pacific (Pte) Ltd. 190 Middle Road #19-05 Fortune Centre Singapore 188979	Email: ptac@perle.com
Worldwide	Perle Systems Ltd. 60 Renfrew Drive Markham Ontario Canada L3R OE1	Email: ptac@perle.com

Index

A

- About this manual [4](#)
- address
 - adding using Host Card Configuration utility [45](#)
 - editing [47](#)
 - removing [49](#)

C

- cable
 - RJ12 to DB25 female [110](#)
 - RJ12 to DB25 male [109](#)
 - RJ12 to DB9 male [108](#)
- cabling information [105](#)
- contacting Perle Systems [149](#)
 - email [149](#)
 - for technical support [150](#)
 - internet [149](#)

D

- Data Terminal Ready [120](#)
- device drivers and utilities
 - installing
 - SCO OpenServer 5 [37](#)
 - SCO UnixWare [61](#)
 - Windows 2000 [81](#)
 - Windows 95 and 98 [20](#)
 - Windows NT [33](#)
 - removing
 - SCO OpenServer 5 [55](#)
 - SCO UnixWare [79](#)
- device names [119](#)
- device node [120](#), [121](#)
- device nodes [119](#)
- downloading drivers from web site [18](#)

- drivers and host cards [17](#)
- DTR [120](#)

E

- editing
 - host card address [47](#)
- email [149](#)
- error messages
 - SCO OpenServer 5 [142](#), [144](#)
- exiting
 - Host Card Configuration utility [50](#)

H

- hardware, removing
 - Windows 95 and 98 [31](#)
- host card address
 - assigning [43](#)
 - editing [47](#)
 - removing [49](#)
- Host Card Configuration utility [43](#)
 - adding a new host card address [45](#)
 - exiting [50](#)
 - menu map [113](#)
 - starting [44](#)
- host cards
 - removing [103](#)

A B C D E F G H I J K L M N O P Q R S T U V W X Y Z

I

- I/O8+ drivers
 - downloading from web site [18](#)
- I/O8+ serial adaptors
 - introduction to [16](#)
- installation [17, 18](#)
 - device drivers and utilities
 - SCO OpenServer 5 [37](#)
 - SCO UnixWare [61](#)
 - Windows 2000 [81](#)
 - Windows 95 and 98 [20](#)
 - Windows NT [33](#)
 - general procedure
 - SCO OpenServer 5 [34](#)
 - SCO UnixWare [58](#)
 - Windows 95 and 98 [19](#)
 - ISA host cards [101](#)
 - PCI host cards [100](#)
 - under SCO OpenServer 5 [34](#)
 - under Windows 95 and 98 [19](#)
 - under Windows NT [33](#)
- ISA host card addresses and IRQ levels
 - SCO UnixWare [64](#)
- ISA host cards
 - address settings [126](#)
 - address, conversion to binary [126](#)
 - addresses, assigning [43](#)
 - installation [101](#)
 - removing [103](#)

M

- menu map
 - Host Card Configuration utility [113](#)
 - Port Configuration utility [114](#)
- menu maps of utilities [112](#)

O

- on-line manual
 - guide to using [5](#)
 - hypertext jumps [5](#)
 - navigation [5](#)
- OpenServer 5, see SCO OpenServer 5

P

- PCI host cards
 - installation [100](#)
 - removing [103](#)
- pinouts
 - RJ12 to DB25 female cable [110](#)
 - RJ12 to DB25 male cable [109](#)
 - RJ12 to DB9 male cable [108](#)
- Port Configuration utility
 - exiting [54](#)
 - menu map [114](#)
 - port login, setting up [54](#)
 - starting [51](#)
- port login
 - setting up under SCO OpenServer 5 [54](#)
- print.io8 configuration file [125](#)
- printcap.io8 configuration file [124](#)
- printing, transparent [122](#)
- problems [124](#)

Q

- quick reference [111](#)

R

- Ready to Send [120](#)
- removing
 - device drivers and utilities
 - SCO OpenServer 5 [55](#)
 - SCO UnixWare [79](#)
 - hardware
 - Windows 95 and 98 [31](#)
 - host card address [49](#)
 - host cards [103](#)
- repair procedure [153](#)
- resources
 - viewing and changing, under windows 2000 [93](#)
- RJ12 socket
 - card edge views [106](#)
 - pinouts [106](#)
- RJ12 to DB25 female cable
 - diagram [110](#)
 - pinouts [110](#)

A B C D E F G H I J K L M N O P Q R S T U V W X Y Z

RJ12 to DB25 male cable
 diagram [109](#)
 pinouts [109](#)
RJ12 to DB9 male cable
 diagram [108](#)
 pinouts [108](#)
RTS [120](#)

S

SCO OpenServer 5 [112](#)
 device drivers and utilities
 installing [37](#)
 removing [55](#)
 upgrading [36](#)
 error messages [142, 144](#)
 general installation procedure [34](#)
 Host Card Configuration utility [43](#)
 installation under [34](#)
 installing device drivers and utilities [37](#)
 Port Configuration utility [51](#)
 troubleshooting [141](#)
SCO UnixWare
 device drivers and utilities
 installing [61](#)
 removing [79](#)
 upgrading [60](#)
 ISA host card addresses and IRQ levels [64](#)
 serial ports, configuring [73](#)
SCO UnixWare 2
 serial ports, configuring [78](#)
serial ports
 configuring
 SCO OpenServer 5 [51](#)
 SCO UnixWare [73](#)
 SCO UnixWare 2 [78](#)
 under Windows 2000 [85, 98](#)
starting Host Card Configuration utility [44](#)

T

technical support [150](#)
 centres worldwide [154](#)
 queries, information needed for [151](#)
 via the internet [152](#)
 who to contact [150](#)

transparent printing [122, 124](#)
 definition of [123](#)
 print.io8 configuration file [125](#)
 printcap.io8 configuration file [124](#)
troubleshooting
 SCO OpenServer 5 [141](#)
 Windows 95 and 98 [132](#)
 Windows NT [140](#)

U

Unixware Device Configuration Utility [64](#)
UnixWare, see SCO UnixWare
upgrading device drivers and utilities
 SCO OpenServer 5 [36](#)
 SCO UnixWare [60](#)
utilities, menu maps [112](#)

W

Windows 2000
 configuring serial ports [85, 98](#)
 device drivers and utilities
 installing [81](#)
 installing device drivers and utilities [81](#)
 viewing and changing the resources for a device [93](#)
Windows 95 and 98
 adding ISA host cards to the system [22](#)
 configuring serial ports [28](#)
 general installation procedure [19](#)
 hardware, removing from system [31](#)
 installation under [19](#)
 installing device drivers and utilities [20](#)
 troubleshooting [132](#)
Windows NT
 device drivers and utilities
 installing [33](#)
 installation under [33](#)
 installing device drivers and utilities [33](#)
 troubleshooting [140](#)