

IOLAN

DS1/TS2

User's Guide

Version 4.9
Part #5500162-46(Rev B)
February 2017

Copyright Statement

This document must not be reproduced in any way whatsoever, either printed or electronically, without the consent of:

Perle Systems Limited,
60 Renfrew Drive
Markham, ON
Canada
L3R 0E1

Perle reserves the right to make changes without further notice, to any products to improve reliability, function, or design.

Perle, the Perle logo, and IOLAN are trademarks of Perle Systems Limited.

Microsoft, Windows NT[®]/Windows 2000[®]/Windows Vista[®]/Windows Server 2003[®]/Windows 2003 R2[®]/Windows 2008[®]/Windows 2008 R2[®]/Windows XP[®]/Windows 7[®]/Windows 8[®]/Windows 8.1[®]/Windows Server 2012[®]/Windows Server 2012 R2[®] and Internet Explorer[®] are trademarks of Microsoft Corporation.

Netscape is a trademark of Netscape Communications Corporation.

Mozilla Firefox is a trademark of the Mozilla Foundation.

Solaris is a registered trademark of Sun Microsystems, Inc. in the USA and other countries.

Perle Systems Limited, 2005-2017.

FCC Note The IOLAN Device Server has been found to comply with the limits for a Class A digital device, pursuant to Part 15 of the FCC rules. These limits are designed to provide reasonable protection against harmful interference when the equipment is operated in a commercial environment. This equipment generates, uses, and can radiate radio frequency energy and, if not installed and used in accordance with the instructions in this Guide, may cause harmful interference to radio communications. Operation of this equipment in a residential area is likely to cause harmful interference, in which case the user will be required to correct the interference at his/her own expense.

EN 55022: 1998, Class A, Note

WARNING This is a Class A product. In a domestic environment this product may cause radio interference in which case the user may be required to take adequate measures.

Caution: the IOLAN Device Server is approved for commercial use only.





Preface

About This Book

This guide provides the information you need to:

- configure the IOLAN
- incorporate the IOLAN into your production environment

Intended Audience

This guide is for administrators who will be configuring the IOLAN.

Some prerequisite knowledge is needed to understand the concepts and examples in this guide:

- Knowledge of TFTP, the transfer protocol the IOLAN uses.

Documentation

The following documentation is included on the IOLAN installation CD:

- *IOLAN 1-Port Quick Start Guide*
- *IOLAN 2-4-Port Quick Start Guide*
- *IOLAN I/O Quick Start Guide*
- *IOLAN DS1/TS2 User's Guide*
- *IOLAN DS1/TS2 Command Line Reference Guide*
- *TruePort User's Guide*
- *TruePort Installation and Configuration Guide for Windows NT[®]*
- Online Help in the DeviceManager (automatically installed with the DeviceManager application)
- Link to knowledge base

Typeface Conventions

Most text is presented in the typeface used in this paragraph. Other typefaces are used to help you identify certain types of information. The other typefaces are:

Typeface Example	Usage
At the C: prompt, type: add host	This typeface is used for code examples and system-generated output. It can represent a line you type in, or a piece of your code, or an example of output.
Set the value to TRUE .	The typeface used for TRUE is also used when referring to an actual value or identifier that you should use or that is used in a code example.
subscribe <i>project subject</i> run yourcode.exec	The italicized portion of these examples shows the typeface used for variables that are placeholders for values you specify. This is found in regular text and in code examples as shown. Instead of entering <i>project</i> , you enter your own value, such as <i>stock_trader</i> , and for yourcode , enter the name of your program.
File, Save	This typeface and comma indicates a path you should follow through the menus. In this example, you select Save from the File menu.
<i>IOLAN User's Guide</i>	This typeface indicates a book or document title.
See <i>About the IOLAN</i> for more information.	This indicates a cross-reference to another chapter or section that you can click on to jump to that section.

Online Help



Online help is provided in the DeviceManager. You can click on the What's This button ( or ) and then click on a field to get field-level help. Or, you can press the **F1** key to get window-level help. You can also get the *User's Guide* online by selecting **Help, Help Topics**.



Table of Contents

Preface	3
About This Book	3
Intended Audience	3
Documentation	3
Typeface Conventions	4
Online Help	4
Chapter 1 Introduction	20
About the IOLAN	20
IOLAN Family Models	20
IOLAN Features	21
Hardware	21
Software	22
Accessing the IOLAN	22
General Features	22
Security	23
Chapter 2 Hardware and Connectivity	24
Introduction	24
IOLAN Components	24
What's Included	24
What You Need to Supply	24
Available Accessories	24
Power Supply Specifications	25

Desktop Models	25
Serial Only Models	25
I/O Models	25
Getting to Know Your IOLAN	25
Overview.....	25
DS1.....	26
TS2	26
I/O.....	27
Top View	27
End View	27
Console/Serial Switch	28
Console Mode	28
Serial Mode	28
Powering Up the IOLAN	29
Models with Barrel Connector.....	29
Models with Terminal Block Connector	29
Chapter 3 Configuration Methods	30
Introduction	30
Configuration Methods Overview.....	31
Configures an IP Address.....	31
Requires a Configured IP Address	31
Easy Config Wizard	32
DeviceManager.....	33
Overview.....	33
Access Platforms	33
Features.....	33
Connecting to the IOLAN Using DeviceManager	33
Using DeviceManager	35
Navigating the Options.....	35
Downloading the Configuration	36
WebManager.....	36
Overview.....	36
Access Platforms	36

Features.....	36
Connecting to the IOLAN Using WebManager	36
Using WebManager	38
Command Line Interface	39
Overview.....	39
Access Platforms	39
Features.....	39
Connecting to the IOLAN Using the CLI.....	39
Through the Network.....	39
Through the Serial Port.....	40
Using the CLI	40
Menu.....	40
Overview.....	40
Access Platforms	40
Features.....	40
Connecting to the IOLAN Using the Menu	40
Using the Menu.....	41
DHCP/BOOTP	42
Overview.....	42
Features.....	42
Connecting to the IOLAN Using DHCP/BOOTP.....	42
Using DHCP/BOOTP.....	42
DHCP/BOOTP Parameters	43
SNMP	44
Overview.....	44
Access Platforms	44
Features.....	44
Connecting to the IOLAN Using SNMP	44
Using the SNMP MIB	45
Chapter 4 Getting Started	46
Introduction	46
Easy Configuration Wizard	46

Setting Up the Network	47
Using DeviceManager	47
Using WebManager	48
Using a Direct Serial Connection to Specify an IP Address.....	48
Using a Direct Serial Connection to Enable BOOTP/DHCP	49
Using ARP-Ping	50
For an IPv6 Network	50
Setting Up the Serial Port(s)	51
Setting Up Users	53
Chapter 5 Using DeviceManager and WebManager.....	54
Introduction	54
Navigating DeviceManager/WebManager	55
DeviceManager	55
WebManager	56
Using DeviceManager to Connect to the IOLAN.....	57
Starting a New Session.....	57
Assigning a Temporary IP Address to a New IOLAN.....	58
Adding/Deleting IOLANs Manually	59
Logging in to the IOLAN	59
Using WebManager to Connect to the IOLAN.....	60
Logging into the IOLAN	60
Configuration Files	60
Creating a New IOLAN Configuration in DeviceManager	60
Opening an Existing Configuration File	61
Importing an Existing Configuration File	61
Managing the IOLAN.....	61
Chapter 6 Configuring Serial Ports	62
Introduction	62
Serial Ports	62

Overview	62
Functionality	62
Editing a Serial Port	63
Resetting a Serial Port	64
Serial Port Profiles	65
Common Tabs	65
Overview	65
Hardware Tab Field Descriptions.....	65
Packet Forwarding Tab Field Descriptions	68
Console Management Profile	70
Overview	70
Functionality	70
General Tab Field Descriptions.....	71
Advanced Tab Field Descriptions	72
TruePort Profile	74
Overview	74
Functionality	74
General Tab Field Descriptions.....	74
Adding/Editing Additional TruePort Hosts	76
Adding/Editing a Multihost Entry	77
Advanced Tab Field Descriptions	78
TCP Sockets Profile	81
Overview	81
Functionality	81
General Tab Field Descriptions.....	81
Adding/Editing Additional Hosts	83
Adding/Editing a Multihost Entry	84
Advanced Tab Field Descriptions	85
UDP Sockets Profile	87
Overview	87
Functionality	87
General Tab Field Descriptions.....	90
Advanced Tab Field Descriptions	91
Terminal Profile	91
Overview	91
Functionality	92
General Tab Field Descriptions.....	92
Advanced Tab Field Descriptions	94
User Service Settings	96
Login Settings	96
Telnet Settings	97
Serial Tunneling Profile	98

Overview	98
Functionality	98
General Tab Field Descriptions.....	99
Advanced Tab Field Descriptions	100
Virtual Modem Profile.....	101
Overview	101
Functionality	101
General Tab Field Descriptions.....	102
Advanced Tab Field Descriptions	103
Phone Number to Host Mapping.....	105
VModem Phone Number Entry	105
Control Signal I/O Profile	106
Overview	106
Functionality	106
General Tab Field Descriptions.....	106
Input Signal Field Descriptions.....	107
Output Signal Field Descriptions.....	108
Modbus Gateway Profile.....	109
Overview	109
Functionality	109
General Tab Field Descriptions.....	110
Advanced Field Descriptions.....	111
Modbus Slave IP Settings Field Descriptions	112
Adding/Editing Modbus Slave IP Settings.....	112
Modbus Slave Advanced Settings Field Descriptions.....	114
Custom Application Profile	115
Overview	115
General Tab Field Description	115
Advanced.....	116
Advanced Serial Settings Tab	116
Overview	116
Field Descriptions.....	116
Modems Tab.....	117
Overview	117
Adding/Editing a Modem.....	117
TruePort Baud Rate Tab	119
Overview	119
Functionality	119
Field Definitions.....	119
Chapter 7 Network Settings	120
Introduction.....	120

IP Settings	121
IPv4 Settings	121
Overview	121
Field Descriptions.....	121
IPv6 Settings	122
Overview	122
Field Descriptions.....	122
Adding/Editing a Custom IPv6 Address	123
Field Descriptions.....	123
Advanced	124
Overview	124
Field Descriptions.....	124
Advanced	125
Host Table	125
Overview	125
Functionality	125
Field Descriptions.....	125
Adding/Editing a Host	125
Route List	126
Overview	126
Functionality	126
Field Descriptions.....	126
Adding/Editing Routes	126
Chapter 8 Configuring Users	128
Introduction	128
User Settings	129
Overview.....	129
Functionality	129
Adding/Editing Users	130
General Tab	130
Overview	130
Functionality	130
Field Descriptions.....	130
Services Tab	132
Overview	132
Functionality	132
Field Descriptions.....	132

Advanced Tab	133
Overview	133
Field Descriptions	133
Sessions Tab	134
Overview	134
Functionality	134
Field Descriptions	135
Serial Port Access Tab	136
Overview	136
Field Descriptions	136
Chapter 9 Configuring Security	137
Introduction	137
Services	137
Overview	137
Functionality	137
Field Descriptions	138
Chapter 10 Configuring I/O Interfaces	139
Introduction	139
Technical Specifications	139
Settings	140
Overview	140
I/O Access Functionality	140
Field Descriptions	140
Advanced Slave Modbus Settings	141
Failsafe Timer Functionality	142
Overview	142
Field Descriptions	142
UDP Functionality	143
Overview	143
Field Descriptions	143
I/O UDP Settings	144
Temperature Functionality	144
Overview	144
Field Descriptions	144
Channels	145

Analog	145
Overview	145
Field Descriptions.....	146
Digital Input	147
Overview	147
Functionality	147
Field Descriptions.....	148
Digital Output	149
Overview	149
Functionality	149
Field Descriptions.....	150
Relay	152
Overview	152
Field Descriptions.....	153
Digital I/O Extension	154
Overview	154
Functionality	155
Field Descriptions.....	156
Adding/Editing Additional Hosts.....	158
Adding/Editing a Multihost Entry	159
Temperature	160
Field Descriptions.....	161
Alarm Settings	162
Basic Analog Alarm Settings.....	162
Advanced Analog Alarm Settings.....	163
I/O UDP	164
UDP Unicast Format	164
UDP Broadcast Packet	164
Analog Section	165
Digital/Relay Section	166
Serial Pin Signal Section	166
UDP Unicast Example	167
I/O Modbus Slave	167
Modbus Serial Application Connected to the Serial Port.....	167
Modbus Serial Application Connected to the Network.....	167
Modbus TCP Application	168
Modbus I/O Access	168
Function Codes	168
I/O Coil/Register Descriptions.....	169

Serial Port Coil/Register Descriptions.....	170
A4/T4 Registers	170
A4D2/A4R2 Registers.....	171
D4/D2R2 Registers	172
Serial Pin Signals	172
TruePort I/O	173
TruePort/Modbus Combination.....	173
API Over TruePort Only	174
Accessing I/O Data Via TruePort.....	175
Introduction.....	175
Setup.....	175
Format of API Commands	176
Get Commands	176
Command Format	176
Response Format.....	176
Set Commands	177
Command Format	177
Successful Response Format	178
Unsuccessful Response Format	178
Error Codes	179
I/O SNMP Traps	179
Chapter 11 Configuring the System	180
Introduction	180
Alerts	180
Syslog	180
Overview	180
Field Descriptions.....	180
Management	181
SNMP	181
Overview	181
Field Descriptions.....	181
SNMP Traps Tab Field Descriptions.....	182
Custom App/Plugin	183
Overview	183

Field Description	183
Advanced	184
Overview	184
Login Tab Field Descriptions.....	184
Bootup Files Tab Field Descriptions	185
Message of the Day (MOTD) Tab Field Descriptions	186
TFTP Tab Field Descriptions	187
Chapter 12 Controlling the I/O Channels	188
Introduction	188
I/O Channels	188
Overview.....	188
Chapter 13 System Administration.....	190
Introduction	190
Managing Configuration Files	190
Saving Configuration Files	190
Downloading Configuration Files	191
Downloading Configuration Files to Multiple IOLANs	192
Uploading Configuration Files	193
Specifying a Custom Factory Default Configuration	193
Resetting the IOLAN to the Default Configuration	194
Downloading IOLAN Firmware	194
Calibrating I/O	194
Calibrating Analog Input.....	194
Calibrating Voltage.....	195
Calibrating Current.....	195
Calibrating Temperature Input	195
Calibrating Thermocouple	195
Calibrating RTD.....	195
Calibrating Analog Channels	196
Resetting Calibration Data.....	196
Setting the IOLAN's Date and Time.....	197
Rebooting the IOLAN.....	197

Resetting the Serial Port Statistics	197
Resetting the IOLAN to Factory Defaults	198
Language Support	198
Loading a Supplied Language	198
Translation Guidance.....	199
Software Upgrades and Language Files	199
Downloading Terminal Definitions	200
Creating Terminal Definition Files	200
Resetting Configuration Parameters	201
Lost admin Password.....	202
Appendix A Virtual Modem AT Commands	203
Virtual Modem Initialization Commands	203
Appendix B Pinouts and Cabling Diagrams	205
Serial Pinouts	205
DB25 Male	205
DB25 Female	206
RJ45.....	207
DB9 Male (Serial Only)	208
DB9 Male I/O.....	208
EIA-232 Cabling Diagrams	209
Terminal DB25 Connector	209
DB25 Male	209
DB25 Female	209
RJ45.....	210
DB9 Male	210
Modem DB25 Connector.....	211
DB25 Male	211
RJ45.....	211
DB9 Male	212
Appendix C Setting Jumpers	213
Introduction	213

1-Port IOLAN	213
IOLAN DB25 Male/Female.....	213
IOLAN RJ45	214
IOLAN DB9	214
2-Port IOLAN	215
Digital I/O Module	216
Analog Input Module	217
Appendix D I/O Wiring Diagrams	218
Wiring I/O Diagrams	218
Digital I/O	218
Digital Input Wet Contact	218
Digital Input Dry Contact.....	218
Digital Output Sink	219
Digital Output Source	219
Analog Input	220
Current	220
Voltage.....	220
Temperature Input	220
Thermocouple	220
RTD 2-Wire	221
RTD 3-Wire	221
RTD 4-Wire	221
Relay Output	221
Normally Open Contact.....	221
Normally Closed Contact	222
Appendix E TruePort Utility	223
Introduction	223
TruePort	223
API I/O Access Over TruePort	224
API Request Format	224
API Response Format	224
Error Codes.....	225
Appendix F Accessories	226
Introduction	226

Starter Kit (Adapters/Cable)	226
RJ45F to DB25M DTE Crossover Adapter	227
RJ45F to DB25M DCE Modem Adapter	228
RJ45F to DB25F DTE Crossover Adapter	229
RJ45F to DB9M DTE Crossover Adapter	230
RJ45F to DB9F DTE Crossover Adapter	231
Sun/Cisco RJ45M Connector Cable for Rack Mount Models	231
Appendix G Troubleshooting	233
Introduction	233
Hardware Problems	233
Communication Issues	233
DeviceManager Problems	234
Host Problems	234
Login Problems	234
Problems with Terminals	235
Unknown IP Address	235
DHCP/BOOTP Problems	236
Language Problems	236
Long Reboot Cycle	236
I/O Models	236
IPv6 Issues	237
Contacting Technical Support	238
Making a Technical Support Query	238
Who To Contact	238
Have Your Product Information Ready	238
Making a support query via the Perle web page	238
Repair Procedure	239
Feedback on this Manual	239

Appendix H Data Logging	240
Introduction	240
Trueport Profile	240
TCP Socket Profile.....	240
Appendix I Modbus Remapping.....	241
Configuring the Modbus UID Translation Feature	241
Glossary	243
Index	245



Introduction

About the IOLAN

The IOLAN is an Ethernet communications/terminal server that allows serial devices to be connected directly to LANs. The IOLAN can connect to a wide range of devices including:

- Terminals for multi-user UNIX systems
- Data acquisition equipment (manufacturing, laboratory, scanners, etc.)
- Retail point-of-sale equipment (bar coding, registers, etc.)
- PCs using terminal emulation
- Modems for remote access and Internet access
- ISDN adapters for branch remote access and Internet access

The performance and flexibility of the IOLAN allows you to use a wide range of high speed devices in complex application environments. The IOLAN products will work in any server environment running TCP/UDP/IP.

IOLAN Family Models

The IOLAN comes in several different models to meet your network needs:

- **DS**—Offered as a 1-port unit (DB25M, DB25F, RJ45, and DB9M interfaces available), this model provides general IOLAN functionality and supports software configurable serial interface protocols EIA-232/422/485.
- **TS**—This model is available with two serial ports (RJ45 only) and supports EIA-232 only. The TS model is similar to the DS model supporting only general IOLAN functionality.
- **SDS**—This model is available in both desktop and rack mount configurations. Both models support software configurable serial interface protocols EIA-232/422/485. The SDS model has the advanced secure IOLAN feature set in addition to the general IOLAN functionality.
- **STS**—This model comes in one desktop model and several rack mount configurations. All models support EIA-232 only. The STS model has the advanced secure IOLAN feature set in addition to the general IOLAN functionality.
- **SCS**—This model comes in several rack mount configurations. All models support EIA-232 only and have an internal PCI card interface. The SCS model has the advanced secure IOLAN feature set in addition to the general IOLAN functionality.
- **MDC**—Offered as a 4-port and 8-port unit (RJ45 only), this model is a medical unit compliant with IEC 60601-1 and has galvanically isolated EIA-232 serial ports. The MDC model has the advanced secure IOLAN feature set in addition to the general IOLAN functionality.

See [Hardware](#) for information about the hardware specifications for your IOLAN model. See [Software](#) for a list of the basic and advanced software features.

IOLAN Features

The IOLAN is a communications server used for making serial network connections. It attaches to your TCP/IP network and allows serial devices such as modems and terminals to access the LAN. It also allows LAN devices to access devices or equipment attached to IOLAN serial ports.

This section highlights the hardware and software components you can expect to find in your IOLAN model.

Hardware

Hardware Features		IOLAN Models												
		Desktop									Rack Mount			Medical unit
		DS1	DS1 I/O	TS2	SDS1\3	SDS1/2/4 P	SDS1 I/O	SDS2/4HL	STS4 P	STS4\8D	SDS	SCS	STS	MDC
Serial Connectors	DB25F	•			•									
	DB25M	•			•									
	RJ45	•		•	•	•		•	•	•	•	•	•	•
	DB9M	•	•		•		•							
Galvanically Isolated Serial Ports	RJ45													•
Serial Interface	EIA-232	•	•	•	•	•	•	•	•	•	•	•	•	•
	EIA-422	•	•		•	•	•	•			•			
	EIA-485	•	•		•	•	•	•			•			
Serial Power In Pin	DB25F	•			•									
	DB25M	•			•									
	RJ45	•			•	•		•	•	• ¹				
Serial Power Out Pin	DB25F				•									
	DB25M				•									
	RJ45				•	•		•	•	• ¹				
Auto Sensing Ethernet Interface	10/100	•	•	•	•	•	•	•	•	•				•
	10/100/1000										•	•	•	
PCI Interface												•		
I/O Interface			•					•						
Optional V.92 Modem					•							•		

Hardware Features		IOLAN Models												
Power Supply	Power over Ethernet					•			•					
	External AC	•		•	•	• ²		•	• ²	•				
	Internal AC										•	•	•	•
	DC		•				•					•	•	
Dedicated Console Port											•	•	•	

Note 1: Not supported on STS8-D.

Note 2: Optional power supply.

Software

This section describes the supported software features available.

Accessing the IOLAN

All IOLAN models can be accessed through any of the following methods:

- Easy Config Wizard, an easy configuration wizard that allows you to quickly setup the IOLAN in a Windows[®] environment
- DeviceManager, a fully functional Windows 2000[®]/Windows Server 2003[®]/Windows Server 2003 R2[®]/Windows XP[®]/Windows Vista[®]/Windows Server 2008[®]/Windows Server 2008 R2[®]/Windows 7[®]/Windows 8[®] and Windows Server 2012[®] configuration/management tool
- WebManager, a web browser (HTTP) option for configuring/managing the IOLAN
- Menu, a window-oriented menu interface for configuration and user access
- CLI, a Command Line Interface option for configuration/management and user access
- SNMP, allowing remote configuration via SNMP as well as statistics gathering
- DHCP/BOOTP, a method of automatically updating the IOLAN

General Features

Basic IOLAN software features are available on all IOLAN models.

- IPv6 support.
- Support for TCP/IP and UDP protocols including telnet and raw connections.
- Virtual modem emulation.
- ‘Fixed tty’ support for several operating systems using Perle’s TruePort utility.
- DHCP/BOOTP for automated network-based setup.
- Dynamic statistics and line status information for fast problem diagnosis.
- Modbus master/slave/gateway support.
- An SDK for custom programs and plugin support.
- I/O interface on the IOLAN I/O models (Analog, Temperature, Digital, and Relay).
- Ability to disable services (for example, Telnet, TruePort, Syslog, SNMP, Modbus, HTTP) for additional security.

Security

The IOLAN security features can include (depending on your IOLAN model):

- Supervisory and serial port password protection.
- Ability to set serial port access rights.
- Ability to assign users access level rights to control their access.
- Idle port timers, which close a connection that has not been active for a specified period of time.
- Ability to individually disable network services that won't be used by the IOLAN.
- Access to fire walled/Nated devices via HTTP tunnels.



Hardware and Connectivity

Introduction

This chapter describes how to physically set up your IOLAN unit. It includes an overview of the IOLAN hardware components and how to power up the IOLAN to make sure it works correctly.

IOLAN Components

What's Included

The following components are included with your product:

- IOLAN unit
- External power supply

Note: DS I/O and Terminal Block models do not have an external power supply.

- *Quick Start Guide* (for I/O models, a soft copy exists on the CDROM)
- A CD-ROM containing documentation, firmware, configuration software, TruePort, etc.
- IOLAN models that have an RJ45 serial connector(s) come with an RJ45→DB9F adapter (not included with TS2 model)

What You Need to Supply

Before you can begin, you need to have the following:

- A serial cable(s) to connect serial devices to your IOLAN unit
- An Ethernet CAT5 10/100/1000BASE-T cable to connect the IOLAN unit to the network

Available Accessories

The following accessories are available for purchase for the various IOLAN models:

- DIN Rail Mounting Kit (35mm) for the desktop models
- 3 meter RJ45M-RJ45M 8-wire Sun/Cisco modular cable
- RJ45 to DB25 DTE Male adapter
- RJ45 to DB25 DCE Male adapter
- RJ45 to DB25 DTE Female adapter
- RJ45 to DB9 Male DTE adapter
- RJ45 to DB9 Female DTE adapter

Contact your distributor for details.

Power Supply Specifications

Desktop Models

Serial Only Models

If you are providing a power supply for a desktop IOLAN model, your power supply must meet the following requirements:

- Output between 9-30V DC.
- DC barrel connector: The cable attached to the power supply should be about 20AWG, length 6 feet approx. The barrel dimensions of the cable-plug are OD=5.5, ID=2.1, and length= 9.5mm, with a straight barrel, and positive polarity on the inside and negative polarity on the outside.
- Power can also be provided by:
 - Serial Port 1, pin 1 on the DS model
 - Serial Port 2, pin 1 on the TS2 model

I/O Models

The power supply for a desktop IOLAN I/O model must meet the following requirement:

- Output between 9-30V DC and a minimum of 600mA current
- 20 AWG wire

Note: The maximum load for the Relay channel is 1A @ 30VDC or 0.5A @ 120VAC.

Getting to Know Your IOLAN

This section describes the hardware components found on your IOLAN unit.

Overview

All IOLANs have the same basic hardware components to allow you to connect to serial devices, connect to the network, monitor LAN and serial activity, and manage the unit. Below is a list of these components:

- **Serial Port(s)**—Connector(s) that will be used to connect to a serial device.
- **Activity**—This LED flashes to indicate LAN activity.
- **Link10/100**—This LED indicates the Ethernet connection speed for desktop models:
 - **Green**—10 Mbits
 - **Yellow**—100 Mbits
 - **Off**—no LAN connection
- **Power/Ready**—This LED can cycle through several colors (yellow, green, red) during a boot process, but should complete with a green light. If the LED is green after power up but continues to cycle on and off (flashes green), this indicates that the console switch is in the **on** position. You can learn more about the Power/Ready LED in [Hardware Problems](#).
- **External Power Supply**—This is an external AC power supply.
- **Console/Serial Switch**—This switch determines whether serial port 1 functions as a serial port or a console port. If you have an I/O model, you will see two console switches. Console/Serial Switch 1 is used to determine the console/serial setting for Port 1 and the Console/Serial Switch 2 is not used.
- **Reset**—The inset RESET button will reboot the IOLAN if pushed in and released quickly. It will reset the IOLAN to factory defaults if pushed in and held for more than three seconds.

- **Serial Activity**
 - **Tx**—Flashes with transmit serial activity. There is a Tx LED for each serial port.
 - **Rx**—Flashes with receive serial activity. There is an Rx LED for each serial port.
- **Ethernet**—The Ethernet connector.

DS1

This section describes the components found on the IOLAN DS1 model.

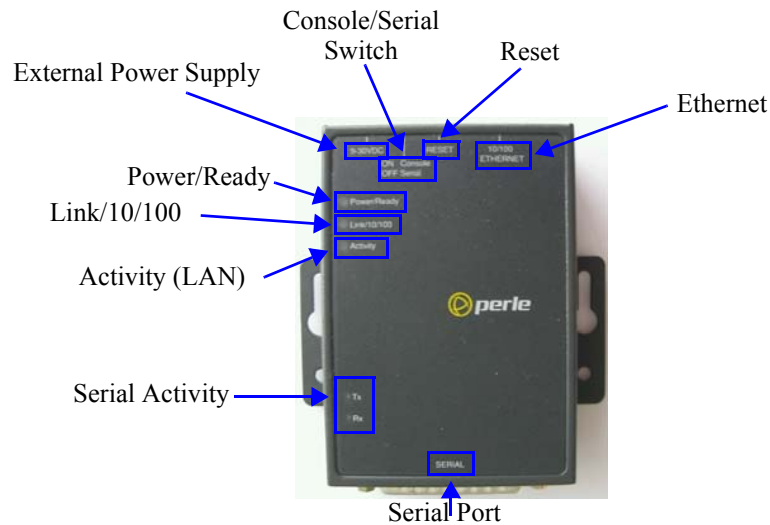

The IOLAN DS1 has one serial connection that is one of the following connectors: DB25 male, DB25 female, RJ45, or DB9 male.

TS2

This section describes the components found on the IOLAN TS2 model.

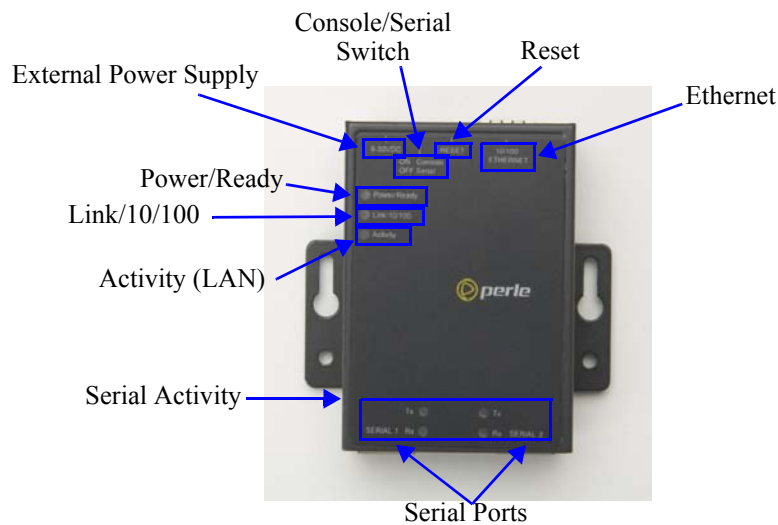

The 2-port IOLAN has two RJ45 serial connections.

I/O

This sections describes the basic components found on the IOLAN I/O models.

Top View

The following image shows a typical IOLAN I/O model. Your I/O model may have I/O connectors in slightly different positions.

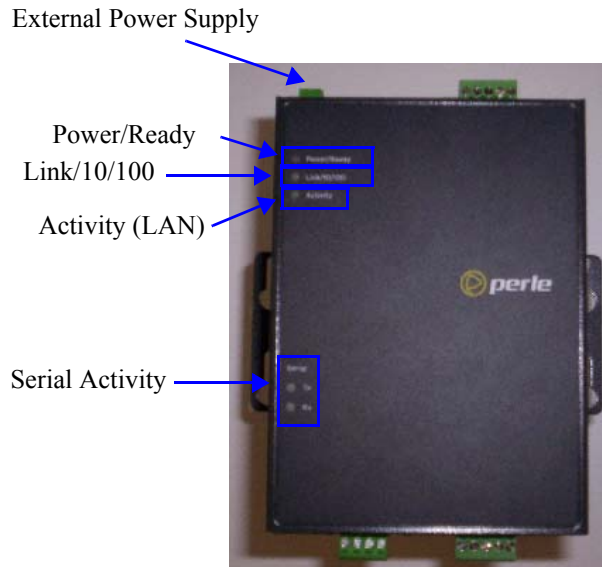

End View

The IOLAN I/O model shown is an A4D2. Different IOLAN I/O models have different I/O connector configurations.

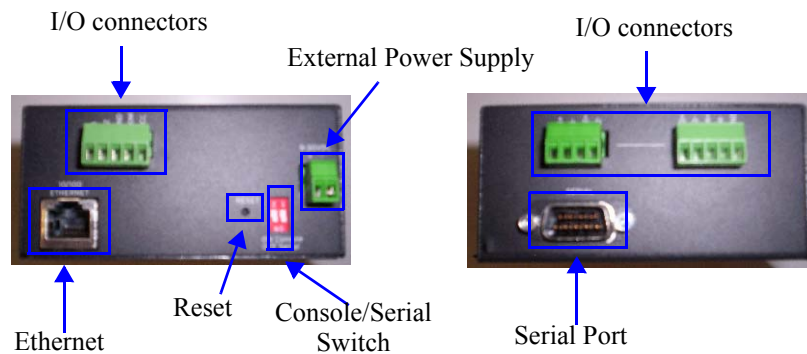

All IOLAN I/O models have a DB9M serial connector.

Console/Serial Switch

Located at the back of the desktop IOLAN models is a switch that controls whether serial port 1 is in Console or Serial mode.

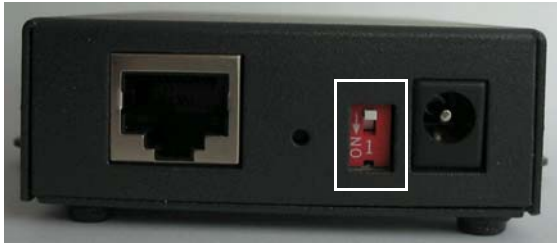

Look at your model to verify the direction of the ON switch position. ON indicates that serial port 1 is in Console mode; otherwise serial port 1 is in Serial mode.

Console Mode

Console mode is used when you have a direct connection between a serial device (like a terminal or a PC) and the IOLAN, accessed by the admin user to configure/manage the IOLAN. Console mode automatically sets serial port settings as:

- **Serial Interface** to **EIA-232**
- **Speed** to **9600**
- **Flow Control** to **No**
- **Bits** to **8**
- **Stop Bits** to **1**
- **Parity** to **None**

Console mode also displays extra system messages.

Serial port 1 will ignore any **Serial Port** settings when in Console mode, so you need to turn Console mode off to use serial port 1 in your network.

Note: When the console switch is in the **on** position, the Power/Ready LED will blink green.

Serial Mode

Serial mode is used when the IOLAN acts as a communications server, or anytime you are not connecting directly to the IOLAN to configure it. You can connect directly to the IOLAN in Serial mode, but the IOLAN will not display all the messages/information you will get in Console mode.

Powering Up the IOLAN

Models with Barrel Connector

To power up the IOLAN, perform the following steps:

1. Plug the external power supply into the IOLAN and then into the electrical outlet.
2. You will see the LEDs cycle for several seconds and then remain a solid green, indicating that it is ready to configure/use.

Before you start to configure the IOLAN, you should set the IOLAN jumpers if you want to terminate the line or use the power in pin feature (instead of an external power supply, if your desktop IOLAN model supports it).

In some circumstances, the setting of jumpers may be required:

- IOLAN DS models where EIA-422/485 line termination is required.
- IOLAN I/O models with Digital I/O for setting the channels as input or output.
- IOLAN I/O models with Analog I/O for setting Voltage/Current.

See [Appendix C, "Setting Jumpers"](#) to see how to set the jumpers for your IOLAN desktop model.

Models with Terminal Block Connector

To power up the unit, perform the following steps:

1. Unplug the power plugable terminal block from the back of the unit.
2. Loosen the screws and then insert your positive (+) wire into the left terminal and screw it down. Insert the negative (-) wire into the right terminal and screw it down as shown below:

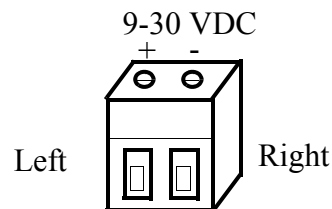

3. Plug the power terminal block back into the unit
4. Plug the power supply into the electrical outlet.
5. You will see the LEDs cycle for several seconds and then remain a solid green, indicating that it is ready to configure/use.

Before you start to configure the IOLAN, you should set the IOLAN jumpers for Digital I/O (see [Digital I/O Module](#)) or Analog Input ([Analog Input Module](#)) channels.



Configuration Methods

Introduction

This chapter provides information about the different methods you can use to configure the IOLAN. Before you can configure the IOLAN, you must assign an IP address to the IOLAN. See the [Getting Started](#) to find out how to assign an IP address to the IOLAN.

Once an IP address is assigned to the IOLAN, you can use any of the configuration methods to:

- Configure users.
- Configure IOLAN system parameters.
- Configure serial port parameters.
- Configure network parameters.
- Configure time parameters.
- Reboot the IOLAN.
- Manage I/O channels (when applicable).
- View statistics while connected to the IOLAN.

Configuration Methods Overview

Some of the IOLAN configuration methods have the capability of configuring an IP address, which is the first required configuration step for a new IOLAN. Once the IOLAN has been assigned an IP address, any of the configuration methods can be used to configure the IOLAN.

Configures an IP Address

Following is a list of methods for setting the IOLAN IP address and a short explanation of when you would want to use that method:

- **Easy Config Wizard**—The Easy Config Wizard is available from the CD ROM included with your IOLAN. You can use the Easy Config Wizard to set the IOLAN's IP address and configure serial ports. This configuration method would typically be used when:
 - All ports are to have the same configuration.
 - Only the most commonly used profiles are required.
 - Straightforward application with no advanced functionality required.
 - Easy Config is installed on a Windows[®]-based PC with local network access to the IOLAN.
- **DeviceManager**—Use this method when you can connect the IOLAN to the network and access the IOLAN from a Windows[®] PC. The DeviceManager is a Windows[®]-based application that can be used for IOLAN configuration and management. The DeviceManager can be used to assign an IP address and perform the complete configuration and management of the IOLAN.
- **Direct Connection**—Use this method when you can connect to the IOLAN from a serial terminal or from a computer running terminal emulation software over a serial port. Using this method, you will need to configure and/or manage the IOLAN using either the Menu or CLI.
- **DHCP/BOOTP**—Use this method when you have a BOOTP or DHCP server running and you can connect the IOLAN to your network. The IOLAN will automatically obtain an IP address from a local network DHCP/BOOTP server when this service is enabled (it is disabled by default). You can also configure certain IOLAN parameters that will be passed from the DHCP/BOOTP server to the IOLAN when it boots up. Other configurators such as DeviceManager, CLI, or Menu can be used to set this option, and obtain the initial IP address.
- **ARP-Ping**—Use this method when you can connect the IOLAN to the network and want to assign a temporary IP address to the IOLAN by adding an ARP entry to your PC and then pinging it.
- **IPv6 Network**—When the IOLAN is connected to an IPv6 network, its local link address is determined using stateless auto configuration.

Once an IP address has been assigned to the IOLAN, in most cases, you can continue to use the same method if it is a configurator or you can switch to any other configuration method.

Requires a Configured IP Address

The following configuration methods require that an IP address already be assigned to the IOLAN.

- **WebManager**—WebManager is a fully functional, browser-based configuration method.

Easy Config Wizard

The Easy Config Wizard is a configuration wizard that will configure all the serial ports on your IOLAN to one of the following:

- Console Management
- TruePort (Virtual COM Port)
- TCP Sockets (Raw TCP)
- Terminal
- Printer (not supported on DS1/TS2 models)
- Serial Tunneling

You can launch the Easy Config Wizard from the Perle website or from the installation CD-ROM.

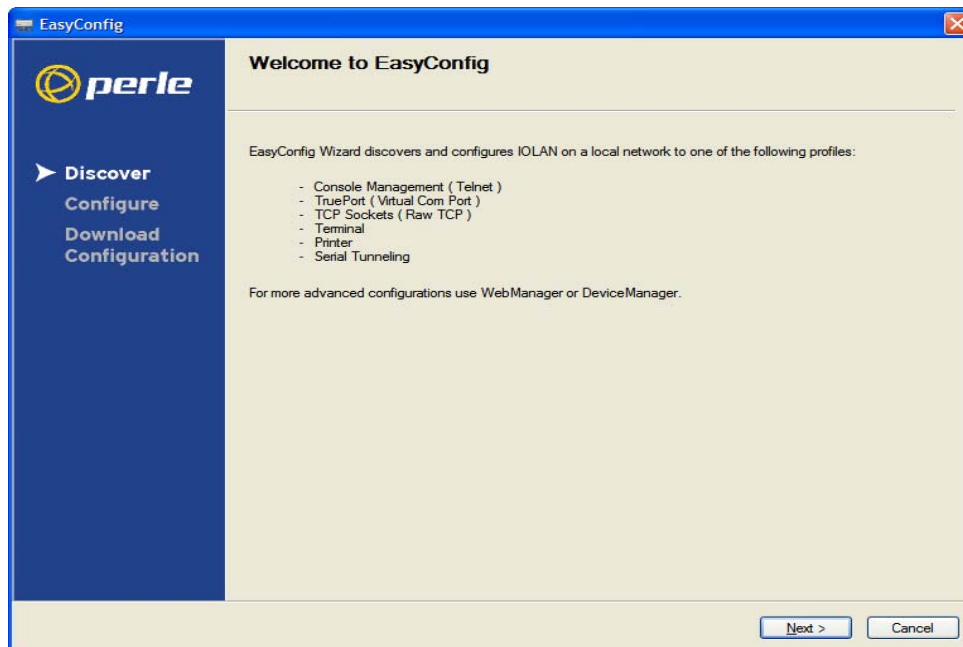

The Easy Config Wizard has been designed to walk you through the configuration process for any of the available configuration options shown on the Welcome window.

DeviceManager

Overview

The DeviceManager is a Windows[®]-based application that can be used to connect to the IOLAN to actively manage and configure it or can create new IOLAN configurations offline. See [Chapter 5, Using DeviceManager and WebManager](#) for information on configuring/managing the IOLAN with DeviceManager.

Access Platforms

The DeviceManager can be run from Windows 2000[®]/Windows Server 2003[®]/Windows Server 2003 R2[®]/Windows XP[®]/Windows Vista[®]/Windows Server 2008[®]/Windows Server 2008 R2[®]/Windows 7[®]/Windows 8[®] and Windows Server 2012[®] platforms. DeviceManager can be installed from the product CD-ROM or downloaded from the Perle website. Unless the IOLAN has already been configured with a Gateway, DeviceManager can only access IOLANs in the local subnet. The DeviceManager can be accessed by only the admin user.

Features

DeviceManager supports the following features:

- The ability to download the same configuration file to several IOLANs in one operation.
- The ability to save a configuration file locally in text format, in addition to the binary format.
- The ability to create a configuration file without being connected to the IOLAN.
- The ability to open a session to the IOLAN and download a (saved) configuration file to it.
- The ability to download custom files, such as new terminal definitions and a custom language files to the IOLAN.

Connecting to the IOLAN Using DeviceManager

Before you can use DeviceManager, you need to install it on your Windows operating system from the IOLAN CD-ROM or you can download it from the Perle website. After the DeviceManager application is installed, click **Start, All Programs, Perle, DeviceManager, DeviceManager** to start the application. When you launch the DeviceManager, it will scan the network for IOLANs:

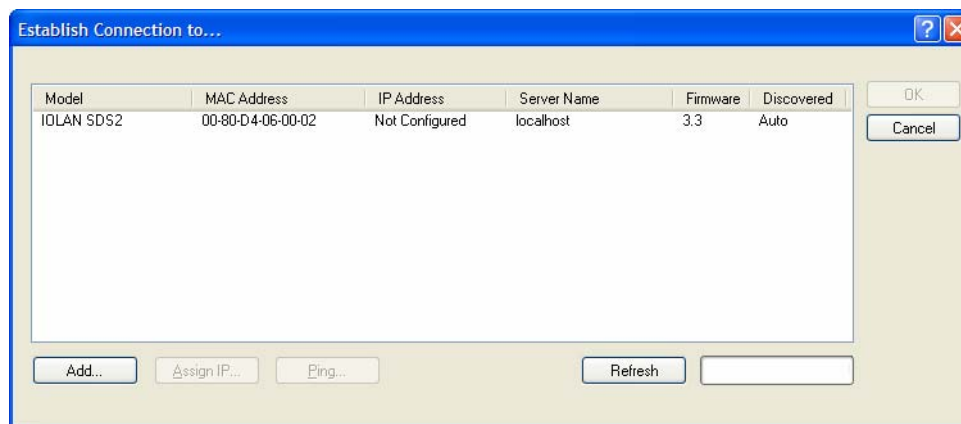

All discovered IOLAN will be displayed on the list along with their name and IP address. When a new IOLAN is discovered on the network, that has not yet been assigned an IP address, it will be displayed with an IP Address of **Not Configured**. To configure the IP address, click on the IOLAN and then click the **Assign IP** button.

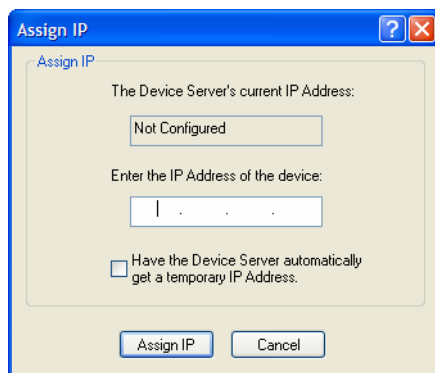

Choose the method you want to use to assign an IP address to the IOLAN:

- Type in the IP address that you want to assign to this IOLAN
- Enable the **Have the IOLAN automatically get a temporary IP Address** option. This will turn on DHCP/BOOTP, so the IOLAN will attempt to get its IP address from your DHCP/BOOTP server. If you don't have a DHCP/BOOTP server, DeviceManager will temporarily assign an IP address in the range of **169.254.0.1-169.254.255.255** that will be used only for the duration of the DeviceManager/IOLAN communication.

After you configure the IP address, click the **Assign IP** button.

The refreshed list now display the assigned IP address for the new IOLAN. To connect to the IOLAN, click the IOLAN entry and click **OK**. You will be asked to supply the Admin password (the factory default password is **superuser**).

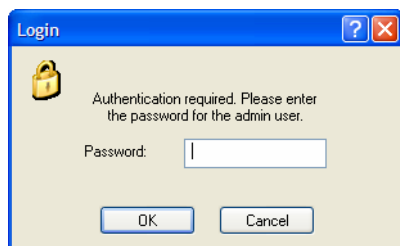

If you have a successful connection, the DeviceManager will retrieve the configuration and then display the IOLAN's System Information and you can begin configuring the IOLAN.

Note: The DeviceManager does not automatically update the IOLAN's configuration. You must download the configuration changes to the IOLAN and then reboot the IOLAN to make the configuration changes take effect

Using DeviceManager

After you have successfully connected to the IOLAN, you will see the following window:

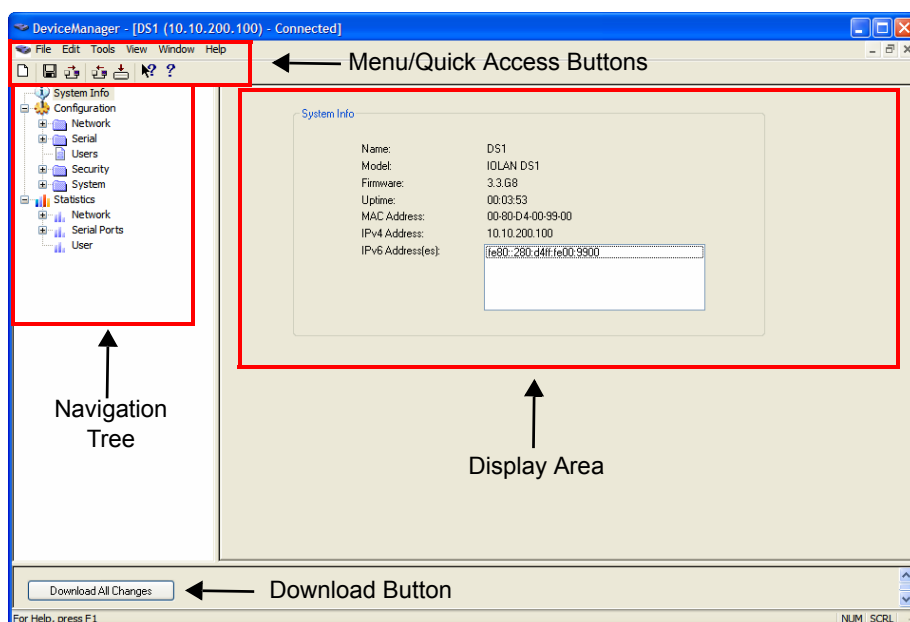

Navigating the Options

The left-hand navigation tree allows you to quickly and easily navigate the various Configuration and Statistics pages of DeviceManager. Further navigation is available in the form of buttons and tabs in the display area of DeviceManager, depending on where you are in the navigation tree, as shown in the below.

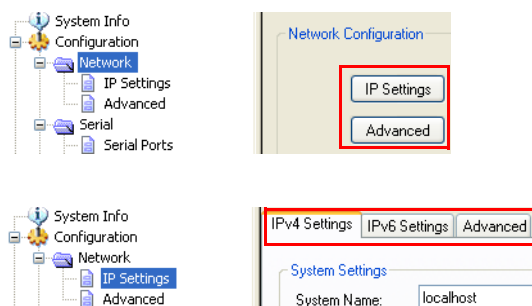

Notice that when you expand a parent node in the tree (e.g., **Serial**), the tree displays the same options that appear as buttons in the display area, as shown below. This gives you the choice of using the navigation tree or buttons to navigate the options.

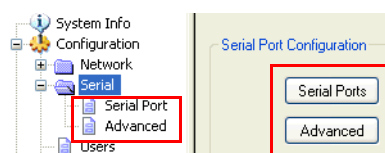

Downloading the Configuration

When you have completed all your configuration changes, click the **Download All Changes** button to download the configuration to the IOLAN. You must reboot the IOLAN for your configuration changes to take effect.

WebManager

Overview

The WebManager is a web browser-based method of configuring/managing the IOLAN. It follows the same design as the DeviceManager, so it is easy to switch between the WebManager and DeviceManager when configuring your IOLAN. See [Using DeviceManager and WebManager](#) for information on configuring/managing the IOLAN with DeviceManager.

Access Platforms

You can access the IOLAN through WebManager from any system that can run a web browser. WebManager can be accessed by the admin user or any user who has Admin Level privileges.

Features

WebManager supports the following features:

- The ability to open a session to the IOLAN and download a (saved) configuration file to it.
- The ability to save a configuration file locally in text format, in addition to the binary format.
- The ability to download/upload keys/certificates to/from the IOLAN.
- The ability to download custom files, such as new terminal definitions and a custom language files to the IOLAN.

Connecting to the IOLAN Using WebManager

Before you can connect to the IOLAN using WebManager, the IOLAN must already be configured with a known IP address; see [Setting Up the Network](#) to configure an IP address on your IOLAN.

To connect to the IOLAN through the WebManager:

1. Open your web browser and type in the IP address of the IOLAN that you want to manage/configure and press **Enter**; for example: `http://123.123.123.123`.
2. If you successfully connect to the IOLAN, a login screen will appear.

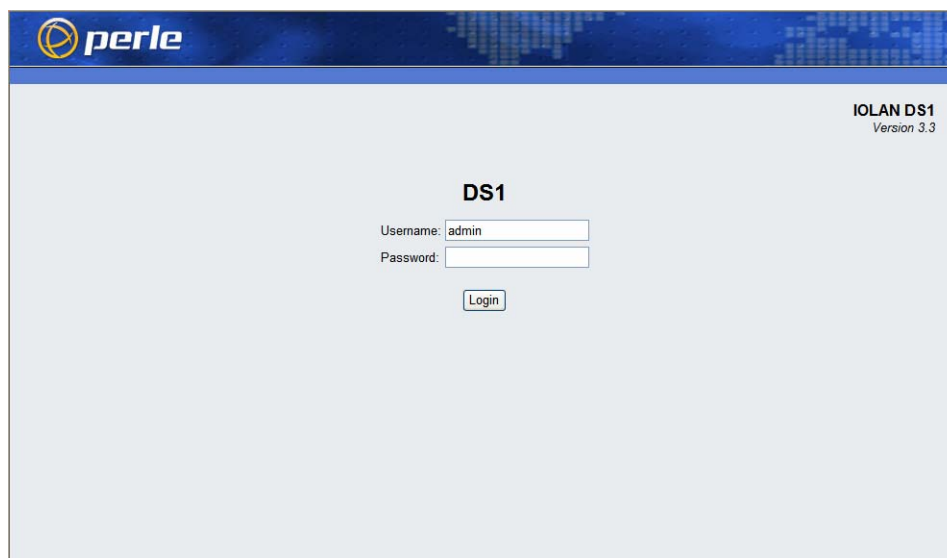

perle

IOLAN DS1
Version 3.3

DS1

Username:

Password:

3. If you are accessing the IOLAN in non-secure HTTP, just type in the admin password (the factory default password is **superuser**)

Using WebManager

After you have successfully logged into WebManager, you will see the following:

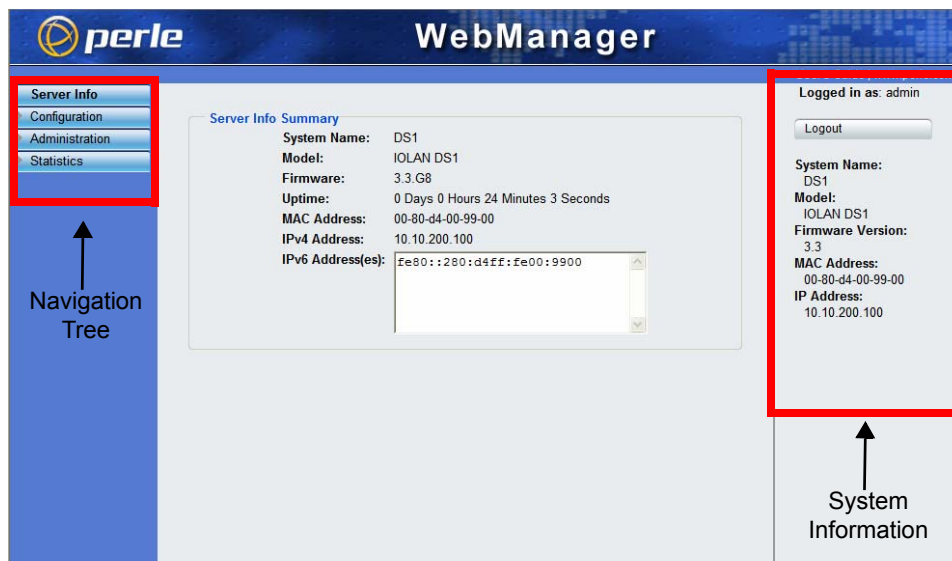

You navigate through the different configuration windows by selecting an option in the left-hand navigation tree. If you click on an option that is next to a folder, more navigation options are displayed when you click on it:

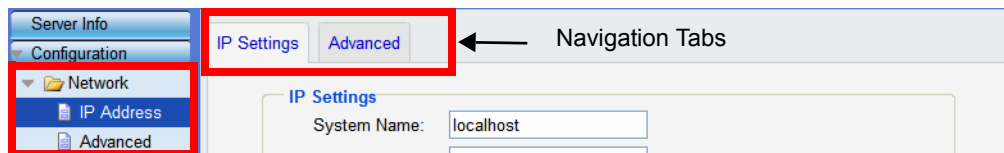

The **Network** folder contains two configuration options, **IP Address** and **Advanced**. Notice that when the **IP Address** option is selected, there are more navigation options in the form of the tabs, **IP Settings** and **Advanced**.

Remember that in the WebManager, it is necessary to press the **Apply** button to save your changes.

Command Line Interface

Overview

The Command Line Interface (CLI) is a command line option for IOLAN configuration/management. See the *Command Line Interface Reference Guide* for a full breakdown of all the CLI commands and their functionality.

Access Platforms

The CLI is accessed by any application that supports a Telnet session to the IOLAN's IP address, such as Putty, SecureCRT, or from a command prompt. You can also access the CLI from a dumb terminal or PC connected to a serial port.

Features

The CLI supports the following features:

- You can access the IOLAN from any application that supports Telnet.
- The ability to clear the ARP table (cache).
- The ability to save a configuration file locally in text format, in addition to the binary format.

Connecting to the IOLAN Using the CLI

There are two ways you can access the IOLAN, through the network (Ethernet connection) or through the serial connection. If you are accessing the IOLAN through the network, the IOLAN must already have a known IP address configured; see [Using a Direct Serial Connection to Specify an IP Address](#) getting started for information on configuring an IP address.

Through the Network

To connect to the IOLAN through the network to configure/manage it using the CLI, do the following:

1. Start a Telnet session to the IOLAN's IP address; for example:

```
telnet 10.10.201.100
```

2. You will get a **Login:** prompt. You can login as the admin user or as a user with Admin Level rights. If the login is successful, you will get a prompt that displays the IOLAN model and number of ports:

```
Login: admin  
Password:
```

```
DS1#
```

You will see a prompt that displays the model and number of the IOLAN. You are now ready to start configuring/managing your IOLAN using the CLI.

Through the Serial Port

To connect to the IOLAN through the serial port to configure/manage it using the CLI (or Menu), see [Using a Direct Serial Connection to Specify an IP Address](#) .

After you have established a connection to the IOLAN, you will get a **Login:** prompt. You can login as the admin user or as a user with Admin Level rights. If the login is successful, you will get a prompt that displays the IOLAN model and number of ports:

```
Login: admin
```

```
Password:
```

```
DS1#
```

You will see a prompt that displays the model and number of the IOLAN. You are now ready to start configuring/managing your IOLAN using the CLI

Using the CLI

After you have successfully logged in, you can start configuring/managing the IOLAN by typing in commands at the prompt. If you are not sure what commands are available, you can type a ? (question mark) at any time during a command to see your options.

See the *Command Line Interface Reference Guide* for more information about the CLI.

Menu

Overview

The Menu is a graphical representation of the CLI. You can look up Menu parameter explanations in the *Command Line Interface Reference Guide*. The only operations that the Menu does not support are the downloading and uploading of files to/from the IOLAN.

Access Platforms

The Menu is accessed by any application that supports a Telnet session to the IOLAN's IP address, such as Putty, SecureCRT, or from a command prompt. You can also access the Menu from a dumb terminal or PC connected to a serial port.

Features

The Menu supports the following features:

- You can access the IOLAN from any application that supports Telnet.
- You can access the IOLAN using a terminal emulator and a serial connection.

Connecting to the IOLAN Using the Menu

To connect the IOLAN using the Menu, follow the directions for [Connecting to the IOLAN Using the CLI](#) .

Using the Menu

After you have successfully logged in, type **screen** at the prompt and press **Enter**. You will be asked to enter a terminal type, and then you will see the following Menu:

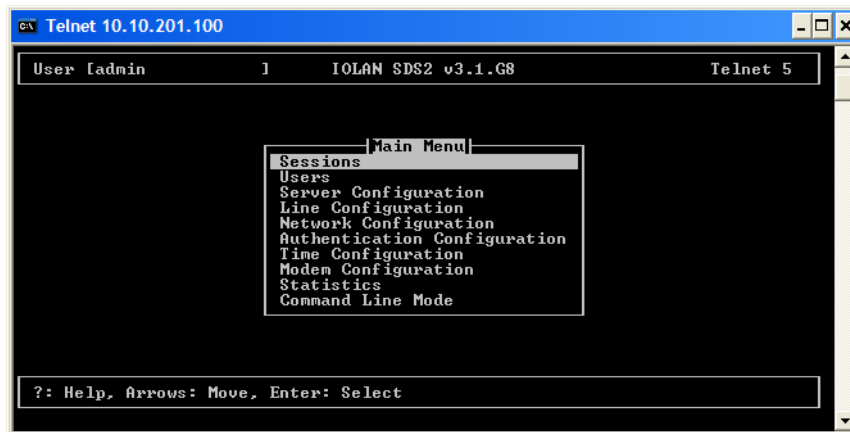

To navigate through the Menu options, do the following:

1. Highlight a Menu option by using the keyboard up and down arrows to navigate the list.
2. When the Menu item you want to access is highlighted, press the **Enter** key to either get to the next list of options or to get the configuration screen, depending on what you select.
3. When you are done configuring parameters in a screen, press the **Enter** key and then the **Enter** key again to **Accept and exit the form**.
4. If you want to discard your changes, press the **Esc** key to exit a screen, at which point you will be prompted with **Changes will be lost, proceed? (y/n)**, type **y** to discard your changes or **n** to return to the screen so you can press **Enter** to submit your changes.
5. If there are a number of predefined options available for a field, you can scroll through those items by pressing the **Space Bar** or you can type **l** (lowercase L) to get a list of options, use the up/down arrows to highlight the option you want, and then press **Enter** to select it.

DHCP/BOOTP

Overview

Several IOLAN parameters can be configured through a DHCP/BOOTP server during the IOLAN bootup. This is particularly useful for configuring multiple IOLANs.

Not all configuration parameters are supported in the DHCP/BOOTP configuration (see [DHCP/BOOTP Parameters](#) for supported configuration parameters), so you will need to use another configuration method, such as DeviceManager, WebManager or CLI, to complete the configuration.

Features

DHCP/BOOTP supports the following features:

- DHCP/BOOTP can supply the IOLAN's IP address.
- The DHCP/BOOTP server can configure certain server and user configuration parameters when the IOLAN is booted.
- The DHCP/BOOTP server can auto-configure the IOLAN with basic setup information (IP address, subnet/prefix bits, etc.).
- The DHCP/BOOTP server can download a new version of firmware when the IOLAN is rebooted.
- The DHCP/BOOTP server can download a full configuration file when the IOLAN is rebooted.

Connecting to the IOLAN Using DHCP/BOOTP

The IOLAN will automatically request an IP address from the DHCP/BOOTP server when the **Obtain IP address automatically using DHCP/BOOTP** parameter is enabled. To enable the **Obtain IP address automatically using DHCP/BOOTP** parameter, follow the directions in [Using a Direct Serial Connection to Enable BOOTP/DHCP](#).

Using DHCP/BOOTP

To use DHCP/BOOTP, edit the bootp file with IOLAN configuration parameters. You can use DHCP/BOOTP to perform the following actions on a single or multiple IOLANs on bootup:

- auto-configure with minimal information; for example, only an IP address
- auto-configure with basic setup information (IP address, subnet/prefix bits, etc.)
- download a new version of firmware
- download a full configuration file

DHCP/BOOTP is particularly useful for multiple installations: you can do all the IOLANs' configuration in one DHCP/BOOTP file, rather than configure each IOLAN manually. Another advantage of DHCP/BOOTP is that you can connect the IOLAN to the network, turn on its power and let autoconfiguration take place. All the configuration is carried out for you during the DHCP/BOOTP process.

DHCP/BOOTP Parameters

The following parameters can be set in the DHCP/BOOTP bootp file:

- **SW_FILE**—The full path, pre-fixed by hostname/IP address (IPv4 or IPv6), and file name of the firmware update.
- **CONFIG_FILE**—The full path, pre-fixed by hostname/IP address (IPv4 or IPv6), and file name of the configuration file. Note: these parameters include clear text user passwords.
- **GUI_ACCESS**—Access to the IOLAN from the HTTP WebManager. Values are **on** or **off**.
- **SECURITY**—Restricts IOLAN access to devices listed in the IOLAN's host table. Values are **yes** or **no**.
- **TFTP_RETRY**—The number of TFTP attempts before aborting. This is a numeric value, for example, 5.
- **TFTP_TMOU**—The time, in seconds, before retrying a TFTP download/upload. This is a numeric value, for example, 3.
- **CUSTOM_LANG**—The full path, pre-fixed by a hostname/IP address (IPv4 or IPv6), and file name of a translated language file. For example,
192.101.34.211 /accounting/Iolan_ds_german.txt.
- **EXTRA_TERM1**—(**EXTRA_TERM2**, **EXTRA_TERM3**) The full path, pre-fixed by a hostname/IP address (IPv4 or IPv6), and file name of a termcap file for a specific terminal type.

SNMP

Overview

The IOLAN supports configuration and management through SNMP. SNMP Management tools (SNMP client/MIB browser software) can be used to set IOLAN configuration parameters and/or view IOLAN statistics.

Before you can configure/manage the IOLAN using SNMP, although you need to set the IOLAN IP address and configure a read-write user for SNMP version 3 or a community for SNMP version 1 or 2. You can use DeviceManager, CLI, or the Menu to set the IP address and user/community (don't forget to reboot the IOLAN before connecting with the SNMP manager to make your changes take effect).

Access Platforms

You can access the IOLAN SNMP MIB from any system that runs your SNMP client/MIB browser software.

Features

SNMP supports the following features:

- You can configure SNMP traps.
- Since not all versions of SNMP support secure communication, password parameters must be set using another configuration method.

Connecting to the IOLAN Using SNMP

Before you can connect to the IOLAN through an SNMP Management tool or MIB browser, you need to set the following components through another configuration method.

1. Configure a known IP address on the IOLAN.
2. Configure a read-write user for SNMP version 3 or a community for SNMP version 1 or 2 on the IOLAN.
3. Reboot the IOLAN to make sure the changes take effect.

To connect to the IOLAN through an SNMP Management tool or MIB browser, do the following:

1. Load the **perle-ds.MIB** file from the IOLAN CD-ROM or Perle website into your SNMP manager (this MIB works for all DS1 and TS2 models).

Note: You need to have the following MIBs installed in your SNMP manager (these are usually part of the standard SNMP client/MIB browser):

- SNMPv2-SMI
- SNMPv2-TC
- IPV6-TC

2. Verify that the read-write user for SNMP version 3 or a community for SNMP version 1 or 2 match the configuration on the IOLAN.
3. Type in the IOLAN's IP address and connect to the IOLAN.

You are now ready to start configuring the IOLAN using SNMP.

Using the SNMP MIB

After you have successfully connected to the IOLAN through your SNMP Management tool or MIB browser, expand the **PERLE-IOLAN-DS-MIB** folder to see the IOLAN's parameter folders. Below is an example of the configurable parameters under the **ServicesInfo** folder.

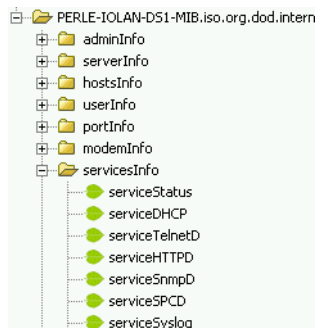

The first variable in each folder is the **Status** variable, for example, **serviceStatus**. When you perform a **GET** on this variable, one of the following values will be returned:

- **1**—Indicates that the container folder is active with no changes.
- **2**—Indicates that the container folder is active with change(s).

Once you have completed setting the variables in a folder, you will want to submit your changes to the IOLAN. To do this, set the **Status** variable to **4**. If you want to discard the changes, set the **Status** variable to **6**.

- **4**—Indicates that the changes in the container folder are to be submitted to the IOLAN.
- **6**—Indicates that the changes in the container folder are to be discarded.

If you want to save all the changes that have been submitted to the IOLAN, you need to expand the **adminInfo** container folder and **SET** the **adminFunction** to **1** to write to FLASH. To make the configuration changes take effect, **SET** the **adminFunction** to **3** to reboot the IOLAN.

4

Getting Started

Introduction

There are several different configuration methods available to configure the IOLAN [Configuration Methods Overview](#) for more information. This chapter describes the three main minimal configuration requirements for the IOLAN through either Easy Config Wizard (cannot configure users using this method), DeviceManager, or WebManager:

1. **Setting up the network**—This minimally consists of configuring an IP address or enabling DHCP/BOOTP. Once the IOLAN has an IP address, you can use any configuration method.
2. **Setting up the serial ports**—You will want to select the serial port profile that matches the serial port requirement/scenario for your serial device.
3. **Setting up users**—This is an optional step, which is only required when your implementation requires users to access the IOLAN.

Easy Configuration Wizard

The Easy Config Wizard quickly sets up the IOLAN's network configuration and all serial ports to one of the following:

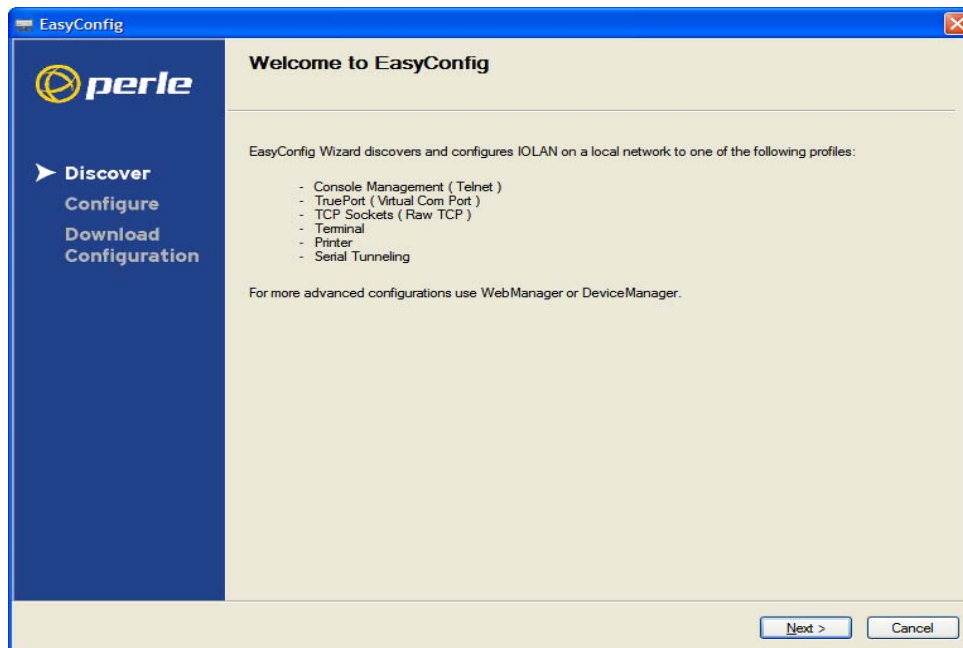

- **Console Management**—Allows users on the network to connect to a serial device that is connected to a serial port on the IOLAN.

- **TruePort (Virtual COM Port)**—Allows a networked system to communicate with your serial device through a virtual COM or TTY port, using the Perle TruePort software.
- **TCP Sockets (Raw TCP)**—Allows hosts on the network to communicate with a serial device that requires raw data throughput (such as a printer or card reader) connected to the IOLAN serial port.
- **Terminal**—Allows a terminal device to connect to a specified host on the network through a serial port on the IOLAN.
- **Printer**—(SDS/STS/SCS only) Allows hosts on the network to talk to a printer using LPD or RCP connected to the IOLAN.
- **Serial Tunneling**—Allows IOLANs on the network to establish a virtual link between their serial ports. Typically, one IOLAN's serial port is configured as a Tunnel Server and the other IOLAN's serial port is configured as a Tunnel Client.

Setting Up the Network

The most important part of setting up the network is assigning an IP address to the IOLAN, whether this is a static IP address or enabling a DHCP/BOOTP-assigned IP address. You should also assign a name to the IOLAN, to make it easier to recognize. This section deals primarily with setting the IP address.

Using DeviceManager

To use the DeviceManager, you must first install it on a Windows® operating system. The DeviceManager is able to automatically discover all IOLANs on your local network, even if they have not yet been assigned an IP address. If routers on the network have been setup to propagate multicasts, DeviceManager will also be able to discover IOLANs in other networks. The DeviceManager installation wizard can be found on the CD-ROM included in the IOLAN package.

1. Connect the IOLAN to the network.
2. Power on the IOLAN.
3. From the CD-ROM that was included in the IOLAN packaging, select the DeviceManager link.
4. Click on the link under **Location** and click **Open** to automatically start the DeviceManager installation.
5. Install the DeviceManager by following the installation wizard. On the last window, check the **Yes, I want to launch DeviceManager now.** box and click the **Finish** button.
6. When you launch the DeviceManager, it will automatically scan the local network and display any IOLANs that it can find.
7. Any IOLAN that does not have an IP address will be displayed as **Not Configured**, with the **Model** and **MAC Address** to identify the IOLAN. Highlight the IOLAN that you want to assign an IP address to and click the **Assign IP** button.
8. Choose the method you want to use to assign an IP address to the IOLAN:
 - Type in the IP address that you want to assign to this IOLAN.
 - Enable the **Have the IOLAN automatically get a temporary IP address** option. This will turn on DHCP/BOOTP, so the IOLAN will attempt to get its IP address from your DHCP/BOOTP server. If you don't have a DHCP/BOOTP server, DeviceManager will temporarily assign an IP address in the range of **169 . 254 . 0 . 1-169 . 254 . 255 . 255** that will be used only for the duration of the DeviceManager/IOLAN communication.

Click the **Assign IP** button.

9. You are now ready to configure the IOLAN. Double-click the IOLAN you just configured the IP address for to open a configuration session. Type **superuser** (the factory default Admin user password) in the Login window and click **OK**.

10. Expand the **Server Configuration** folder and select **Server**. Verify the IP address configuration. You should also enter a name in the **Server Name** field to make the IOLAN easily identifiable.
11. To make your edits take effect, you need to download the new configuration file and then reboot the IOLAN. Download the configuration file to the IOLAN by selecting **Tools, Download Configuration to Unit** or click the **Download All Changes** button.
12. Reboot the IOLAN by selecting **Tools, Reboot Server** or click the **Reboot IOLAN** button.

For more information on configuring the IOLAN using DeviceManager, see [Chapter 5 Using DeviceManager and WebManager](#).

Using WebManager

To use the WebManager as your configurator, you must first assign an IP address to the IOLAN. You can use the Easy Config Wizard to assign an IP address to the IOLAN or any of the other methods described in this section. Once the IP address is assigned to the IOLAN, simply type the IP address into the **Address** field of your web browser and press the **Enter** key.

Using a Direct Serial Connection to Specify an IP Address

You can connect to the IOLAN's serial console port using a PC with a terminal emulation package, such as HyperTerminal or a terminal.

1. Connect the IOLAN to your PC or dumb terminal. Make sure the DIP switch is in Console mode (desktop models, this sets the IOLAN serial port 1 to EIA-232). When connecting a terminal or PC directly (without modems), the EIA-232 signals need to be crossed over ('null modem' cable). See [EIA-232 Cabling Diagrams](#) for cabling diagrams.
2. Using a PC emulation application, such as HyperTerminal, or from a dumb terminal, set the Port settings to 9600 Baud, 8 Data bits, No Parity, 1 Stop Bits, and No Hardware Flow control to connect to the IOLAN.
3. When prompted, type **admin** for the User and **superuser** for the Password. You should now see the a prompt that displays the model type and port number; for example, **DS1#**.
4. You are now logged into the IOLAN and can set the IP address by typing from the command line using the Command Line Interface (CLI).

Type:

```
set server internet <ipv4address>
```

Where *ipv4address* is the IP Address being assigned to the IOLAN.

5. Type the following command:

```
save
```

6. If you are going to use another configuration method, such as WebManager or DeviceManager, unplug a desktop IOLAN. On a desktop IOLAN, change the DIP switch to Off Serial (DIP switch in the up position) and connect it to your serial device. Plug the IOLAN back in, automatically rebooting the IOLAN in the process.
7. If you want to complete the configuration using a direct connection, see [Command Line Interface](#) and/or [Menu](#). After you complete configuring the IOLAN, unplug the IOLAN. If this is a desktop model, change the IOLAN DIP switch to Off Serial (DIP switch in the up position) and connect it to your serial device. Plug the IOLAN back in, automatically rebooting the IOLAN in the process.

Using a Direct Serial Connection to Enable BOOTP/DHCP

If you are using BOOTP, you need to add an entry in the BOOTP server for the IOLAN that associates the MAC address (found on the back of the IOLAN) and the IP address that you want to assign to the IOLAN. After you have made the MAC address/IP address association for BOOTP, use the following directions for BOOTP or DHCP.

You can connect to the IOLAN using a PC with a terminal emulation package, such as HyperTerminal or a dumb terminal.

1. Connect the IOLAN to your PC or dumb terminal. Make sure the DIP switch is in Console mode (desktop models, this sets the IOLAN serial port to EIA-232). When connecting a terminal or PC directly (without modems), the EIA-232 signals need to be crossed over ('null modem' cable). See [EIA-232 Cabling Diagrams](#) for cabling diagrams.
2. Using a PC emulation application, such as HyperTerminal, or from a dumb terminal, set the Port settings to 9600 Baud, 8 Data bits, No Parity, 1 Stop Bits, and No Hardware Flow control to connect to the IOLAN.
3. When prompted, type **admin** for the User and **superuser** for the Password. You should now see the a prompt that displays the model type and port number; for example, **DS1#**.
4. You are now logged into the IOLAN and can set the IP address by typing from the command line using the Command Line Interface (CLI). Type the following command:

```
set server internet dhcp/bootp on
```

5. Type the following command:

```
save
```

6. Type the following command:

```
reboot
```

7. When the IOLAN reboots, it will automatically poll for an IP address from the DHCP/BOOTP server.

8. To view the DHCP/BOOTP assigned IP address, type the following command:

```
show interface ethernet
```

If for some reason it cannot obtain an IP address from your DHCP/BOOTP server, you will have to either reconnect to the IOLAN on the console port and reboot it or push the Reset to Factory button to access the IOLAN.

You are now ready to configure the IOLAN. See [Configuration Methods Overview](#) for information on the different IOLAN configuration methods.

Using ARP-Ping

You can use the ARP-Ping (Address Resolution Protocol) method to temporarily assign an IP address and connect to your IOLAN to assign a permanent IP address. To use ARP-Ping to temporarily assign an IP address:

1. From a local UNIX/Linux host, type the following at the system command shell prompt:

```
arp -s a.b.c.d aa:bb:cc:dd:ee:ff
```

On a Windows[®] 2000 or newer system, type the following at the command prompt:

```
arp -s a.b.c.d aa-bb-cc-dd-ee-ff
```

(where **a.b.c.d** is the IPv4 address you want to temporarily assign to the IOLAN, and **aa:bb:cc:dd:ee:ff** is the Ethernet (MAC) address of IOLAN (found on the back of the unit).

2. Whether you use UNIX or Windows[®], you are now ready to ping to the IOLAN. Here is a UNIX example of the sequence to use:

```
arp -s 192.168.209.8 00:80:d4:00:33:4e
ping 192.168.209.8
```

From the ping command issued in step 2, the IOLAN will pickup and use the IP address entered into the ARP table in step 1. You are now ready to configure the IOLAN. See [Configuration Methods Overview](#) for information on the different IOLAN configuration methods.

For an IPv6 Network

The IOLAN has a factory default link local IPv6 address that takes the following format:

IOLAN MAC Address: 00-80-D4-AB-CD-EF

Link Local Address: fe80::0280:D4ff:feAB:CDEF

The IOLAN will also listen for IPv6 router advertisements to learn a global address. You do not need to configure an IPv4 address for IOLANs residing in an IPv6 network.

You are now ready to configure the IOLAN. See [Configuration Methods Overview](#) for information on the different IOLAN configuration methods.

Setting Up the Serial Port(s)

The DeviceManager and WebManager have the following serial port profiles that will simplify serial port setup:

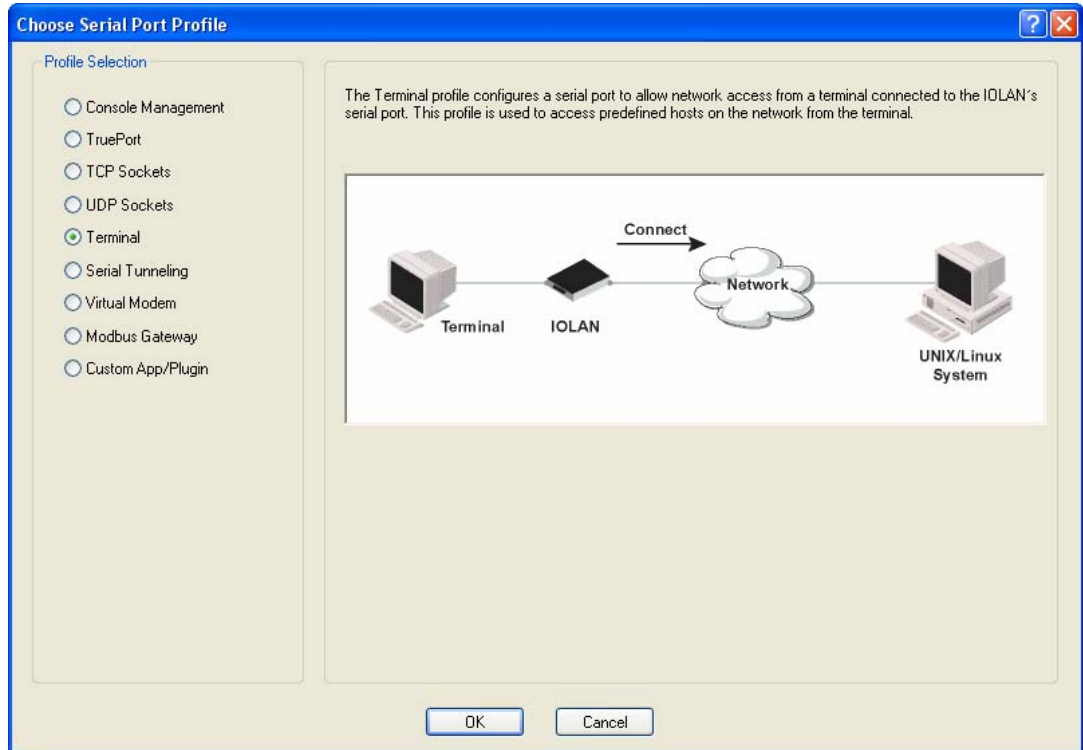

- **Console Management**—The Console Management profile configures a serial port to provide network access to a console or administrative port. This profile sets up a serial port to support a TCP socket that listens for a Telnet connection from the network.
- **TruePort**—The TruePort profile configures a serial port to connect network servers or workstations running the TruePort software to a serial device as a virtual COM port. This profile is ideal for connecting multiple serial ports to a network system or server.
- **TCP Sockets**—The TCP Sockets profile configures a serial port to allow a serial device to communicate over a TCP network. The TCP connection can be configured to be initiated from the network, a serial device connected to the serial port, or both. This is sometimes referred to as a raw connection or a TCP raw connection.
- **UDP Sockets**—The UDP Sockets profile configures a serial port to allow communication between the network and serial devices connected to the IOLAN using the UDP protocol.
- **Terminal**—The Terminal profile configures a serial port to allow network access from a terminal connected to the IOLAN's serial port. This profile is used to access predefined hosts on the network from the terminal.
- **Serial Tunneling**—The Serial Tunneling profile configures a serial port to establish a virtual link over the network to a serial port on another IOLAN. Both IOLAN serial ports must be configured for Serial Tunneling (typically one serial port is configured as a Tunnel Server and the other serial port as a Tunnel Client).
- **Virtual Modem**—The Virtual Modem (Vmodem) profile configures a serial port to simulate a modem. When the serial device connected to the IOLAN initiates a modem connection, the IOLAN starts up a TCP connection to another IOLAN configured with a Virtual Modem serial port or to a host running a TCP application.

- **Control Signal I/O**—The Control Signal I/O profile enables the use of the EIA-232 serial port signal pins to be used as assigned Digital Inputs or Digital Outputs.
- **Modbus Gateway**—The Modbus Gateway profile configures a serial port to act as a Modbus Master Gateway or a Modbus Slave Gateway.
- **Custom Application/Plugin**—The Custom Application/Plugin profile configures a serial port to run a custom application or IOLAN plugin. After you download the custom application files and specify the application name and any parameters you want to pass to it, the IOLAN will execute the application when the serial port is started.

Each serial port profile contains all the parameters that are required to completely configure the serial port scenario represented by the profile.

To select a serial port profile in the DeviceManager, connect through the DeviceManager to the IOLAN you are configuring and select **Serial, Serial Ports** in the navigation pane. Highlight the serial port you want to configure and then click **Edit**.

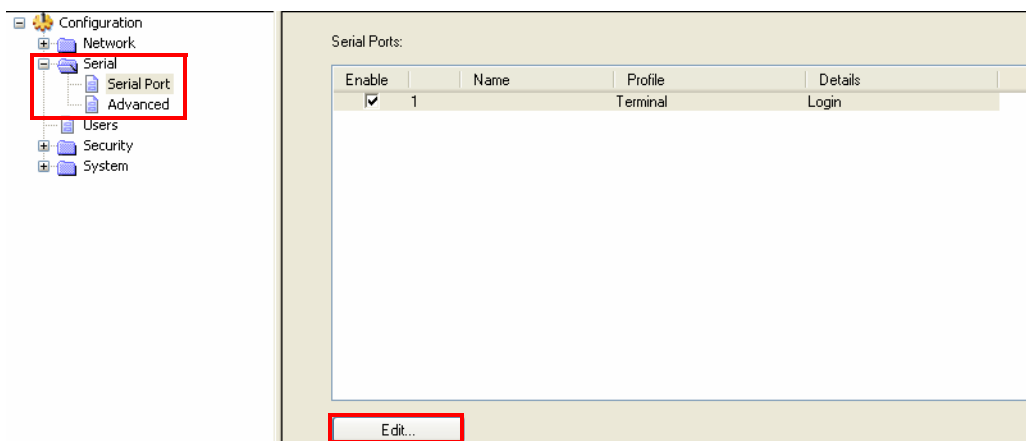

When the default serial port profile Terminal displays, click the **Change Profile** button and select the appropriate profile for the serial port. See [Chapter 6, *Configuring Serial Ports*](#) for more information on the serial port profiles and their configuration parameters.

Setting Up Users

When you have a user who is accessing a device connected to a serial port from the network or who is accessing the network from a device connected to a serial port through the IOLAN, you can create a user account and configure the user's access privileges. Notice that there is a Default user; the Default user's parameters are inherited by users accessing a serial port configured for the **Terminal** profile with the **Connect to remote system** option enabled.

To add a user account, click on the **Users** page in the navigation pane.

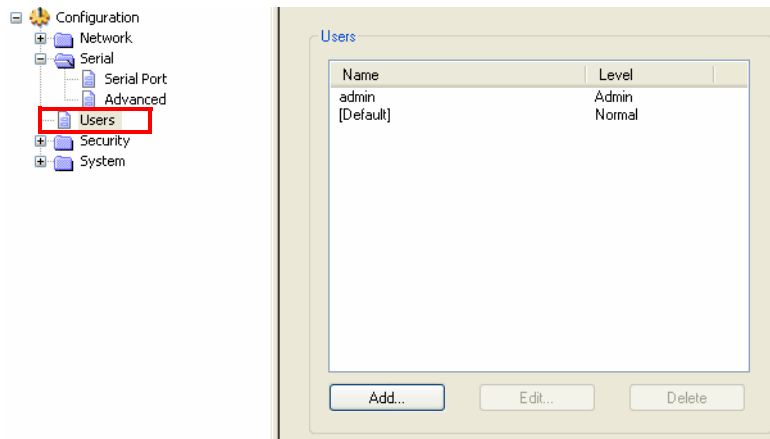

Click the **Add** button to create a user account.

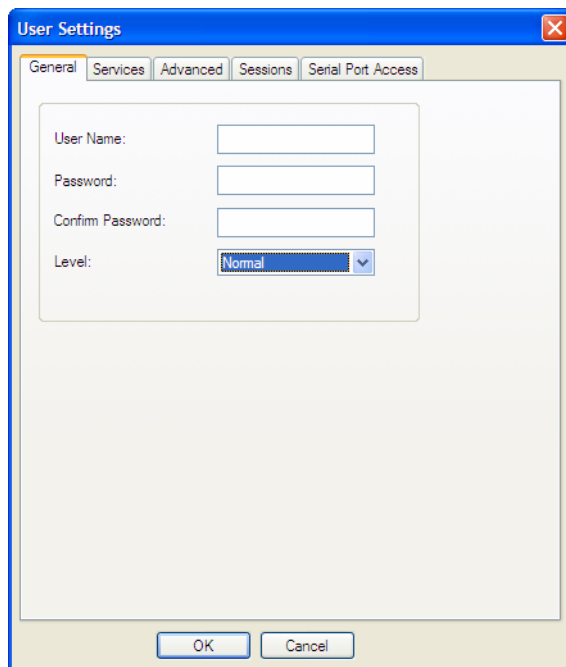

To quickly add a user, fill out the field in the **General** tab and click **OK**.

See [Chapter 8, Configuring Users](#) for more information about the other user parameters you can configure.



Using DeviceManager and WebManager

Introduction

The DeviceManager and WebManager IOLAN managers have been designed to be very similar to use. DeviceManager is a Windows[®]-based application and WebManager is a browser-based application. Both options use the IOLAN's IP address to access the IOLAN; the DeviceManager can be used to assign an IP address to a new IOLAN and the WebManager requires that the IOLAN already have an IP address before it can be used to configure the IOLAN.

When using WebManager, you are required to click the **Apply** button each time you make a change to a configuration window/tab. In DeviceManager, you must download your configuration changes to the IOLAN either periodically or after you are done with the configuration changes. From both managers you must reboot the IOLAN in order for you configuration changes to take effect.

Navigating DeviceManager/WebManager

The DeviceManager and WebManager have very similar navigation methods. The left-hand side of the manager is the navigation tree and the center is the configuration area. The DeviceManager has menu and quick access buttons, whereas the WebManager has system information and some navigation options on the far right-hand side.

DeviceManager

The DeviceManager has a navigation tree that you can use to access the available Configuration and Statistics pages in the display area. When you select an option in the navigation tree, you can often navigate the tabs or buttons in the display area to access the various configuration and statistics options. See [Using DeviceManager](#) for more information on how to navigate the pages of DeviceManager.

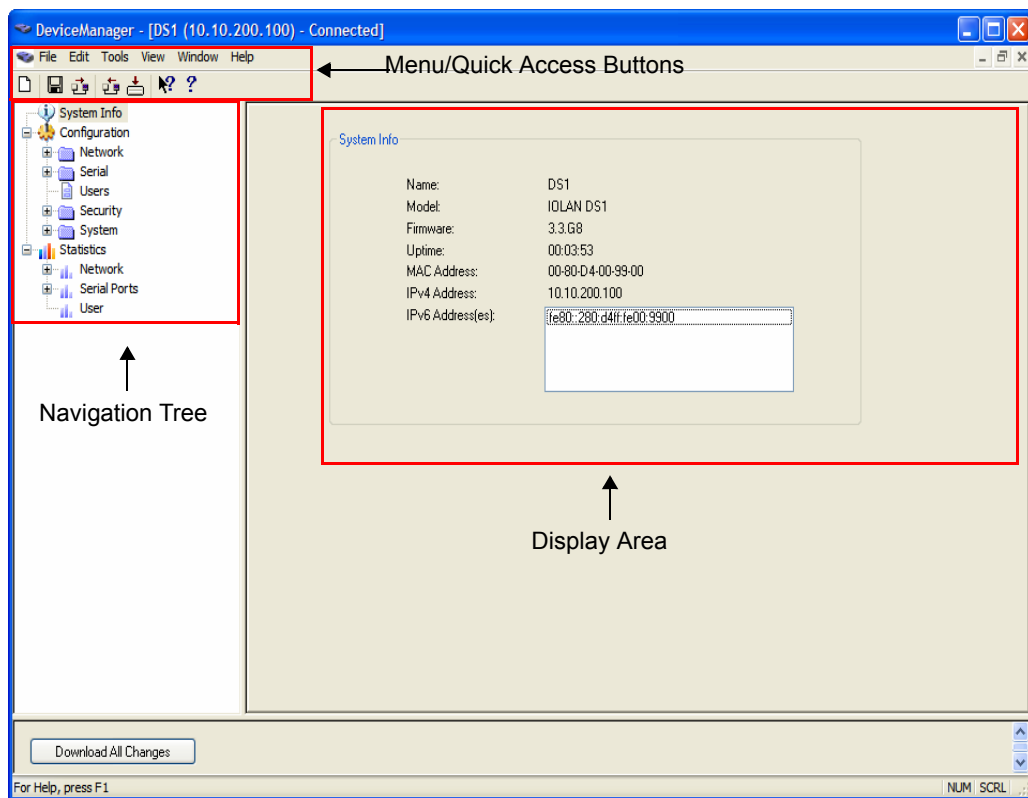

WebManager

The WebManager uses an expandable/collapsible buttons with folders and pages for the navigation tree. You can expand the buttons to view the folders and pages to see the available configuration options. When you access a configuration page, you can often navigate the tabs in the configuration area to access all of the configuration options.

The screenshot displays the Perle WebManager interface. At the top, the Perle logo and 'WebManager' title are visible. The interface is divided into several sections:

- Navigation Tree (Left):** A vertical blue sidebar containing a list of menu items: 'Server Info', 'Configuration', 'Administration', and 'Statistics'. An upward-pointing arrow labeled 'Navigation Tree' is positioned below this sidebar.
- Configuration Area (Center):** A large light gray area containing a 'Server Info Summary' box. This box lists system details:
 - System Name: DS1
 - Model: IOLAN DS1
 - Firmware: 3.3.G8
 - Uptime: 0 Days 0 Hours 24 Minutes 3 Seconds
 - MAC Address: 00-80-d4-00-99-00
 - IPv4 Address: 10.10.200.100
 - IPv6 Address(es): fe80::280:d4ff:fe00:9900
 An upward-pointing arrow labeled 'Configuration Area' is positioned below this section.
- System Info/Navigation (Right):** A vertical light gray sidebar containing:
 - Links for 'User's Guide | www.perle.com' and 'Logged in as: admin'.
 - A 'Logout' button.
 - A summary of system information: System Name: DS1, Model: IOLAN DS1, Firmware Version: 3.3, MAC Address: 00-80-d4-00-99-00, and IP Address: 10.10.200.100.
 An upward-pointing arrow labeled 'System Info/Navigation' is positioned below this sidebar.

Using DeviceManager to Connect to the IOLAN

DeviceManager can connect to existing IOLANs or assign an IP address to a new IOLAN. Whenever you connect to the IOLAN through the DeviceManager, you connect as the Admin user and must supply the password for the Admin user.

Starting a New Session

To start a new session and connect to the IOLAN using the DeviceManager:

1. Start the DeviceManager by selecting **Start, All Programs, Perle, DeviceManager, DeviceManager**.
2. When the DeviceManager starts, it searches the network for IOLANs.

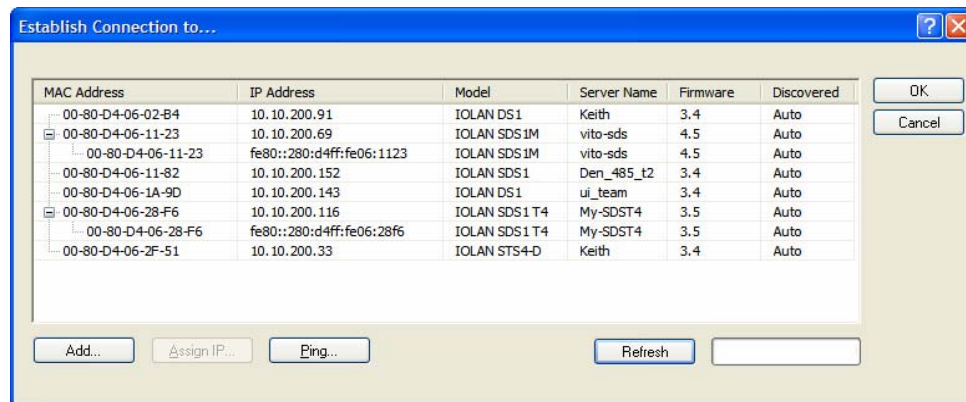

Note: If you are not seeing IPv6 addresses in the list (you must expand the entry), see [IPv6 Issues](#) to find out how to install IPv6 support.

If your IOLAN is not in the local network and you do not have a multicast enabled router in your network and therefore is not displayed in the selectable list, but can be pinged from your PC, you can add it to the selectable list by clicking the **Add** button.

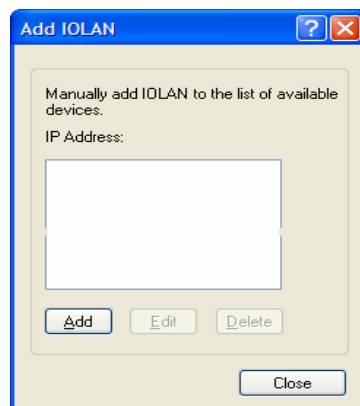

Click the **Add** button and type in the IOLAN's IP address; this field supports IPv4 and IPv6 addresses. Click the **Close** button when you have completed adding all the manual entries. Select the manually added server to connect to it.

Assigning a Temporary IP Address to a New IOLAN

You can temporarily assign an IP address to the IOLAN that is connected to your local network segment, for the purpose of connecting to it and downloading a configuration file (containing a permanent IP address). To temporarily assign an IP address to the IOLAN, do the following:

1. Click the **Refresh** button. The IOLAN will be displayed in the **IP Address** column as **Not Configured**.
2. Select the new IOLAN and click the **Assign IP** button. The following window is displayed:

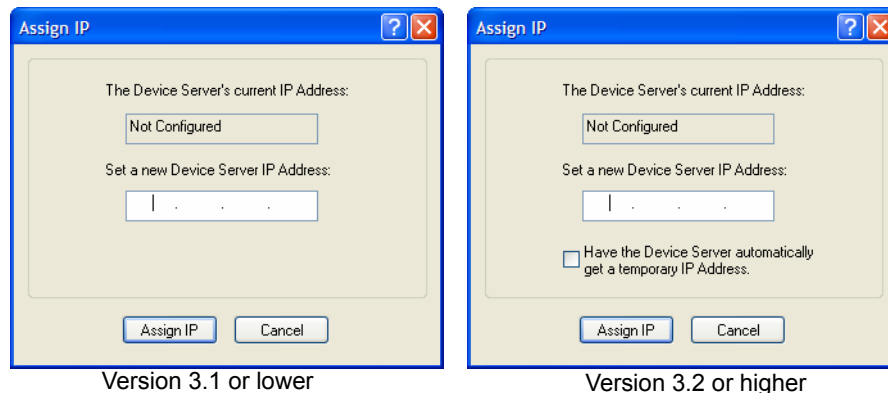

3. Type a valid temporary IP address into the address field or, in version 3.2 or higher, enable the **Have the IOLAN automatically get a temporary IP address**. If you enable the temporary IP address, the IOLAN will enable DHCP/BOOTP on your IOLAN and attempt to get an IP address from the DHCP/BOOTP server (this will permanently enable DHCP/BOOTP in your IOLAN's configuration, until you change it). If your network does not have a DHCP/BOOTP server, the IOLAN will temporarily assign an IP address in the range of **169.254.0.1-169.254.255.255** (this IP address is only assigned for the duration of the DeviceManager/IOLAN connection).
4. Click the **Assign IP** button.
5. Double-click the IOLAN in the **IOLAN List**. If this is the first time you are accessing the IOLAN, type in the factory default Admin password, **superuser**, and click **OK**. The DeviceManager will display a window indicating that it is trying to authenticate and connect you on the IOLAN.
6. If the authentication and connection are successful, the Server Info window is displayed. You are now ready to configure the IOLAN. If authentication was unsuccessful, try to connect to the IOLAN again; you probably mistyped the password for the Admin user.

For more information about managing the IOLAN, see [Configuration Files](#).

Adding/Deleting IOLANs Manually

To permanently add/delete IOLANs to/from the IOLAN **List**, click the **Add** button. The following window is displayed:

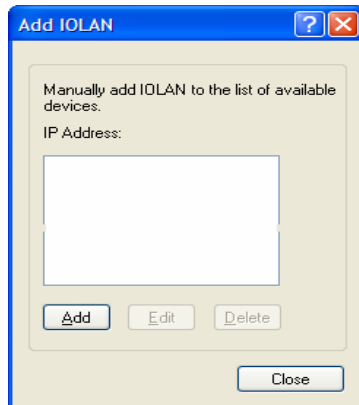

To permanently add the IOLAN to the IOLAN list, type in the IP address of the IOLAN and click the **Add** button and enter the IPv4 or IPv6 address. To permanently delete the IOLAN from the IOLAN list, select the IOLAN's IP address and click the **Delete** button.

Logging in to the IOLAN

To log in to the IOLAN, double-click on the IOLAN in the **Device Server List**. You will be prompted for the Admin Password (the default is **superuser**).



If the authentication and connection are successful, the IOLAN's **Server Info** window is displayed.

If you cannot connect to the IOLAN, you can highlight the IOLAN and click the **Ping** button to verify that the DeviceManager can communicate with the IOLAN's IP Address. If the ping times out, then you might need to set up a Gateway in your IOLAN or verify that your network is communicating correctly.

Using WebManager to Connect to the IOLAN

WebManager can only connect to IOLANs that already have an assigned IP address. To connect to the IOLAN, type the IP address of the IOLAN into the **Address** field as such:

http://10.10.234.34.

You will see the login screen.

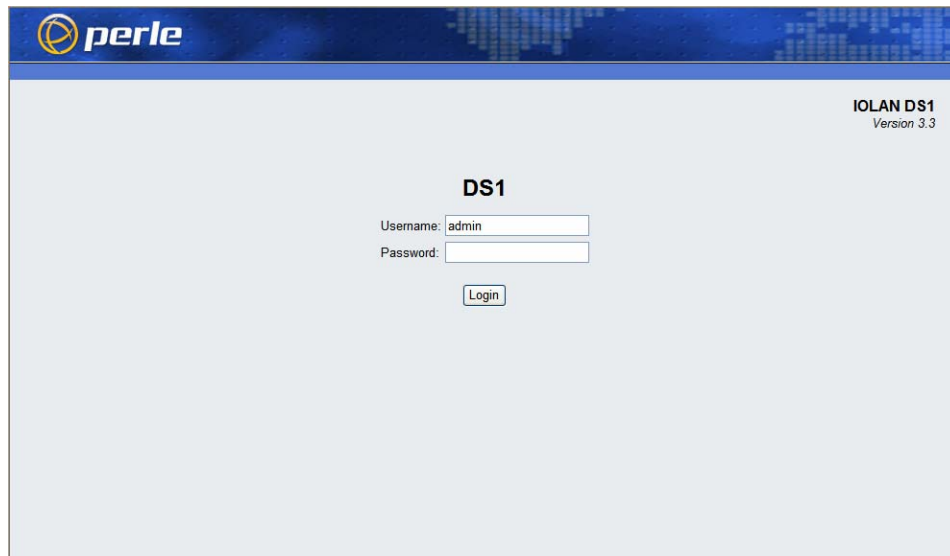

Logging into the IOLAN

Type in the admin password in the **Password** field and click the **Login** button.

Configuration Files

Creating a New IOLAN Configuration in DeviceManager

In DeviceManager, when you select **File, New**, the New Configuration window is displayed.

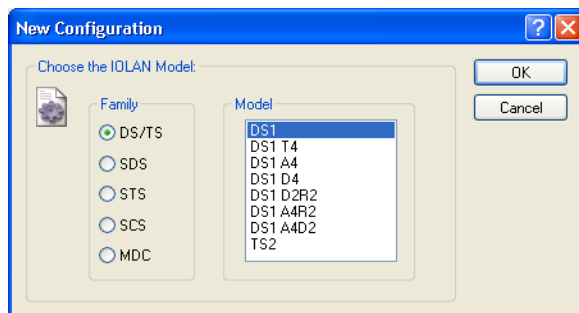

Select the IOLAN model for which you want to create a new configuration file. Any configuration file created in this manner can only be save locally. To download a created configuration file, you must first connect to the IOLAN, import the created configuration file into DeviceManager (this is not available in WebManager), and then download the configuration file to the IOLAN and reboot it.

Opening an Existing Configuration File

If you select the **File, Open**, a browse window is opened so you can select the configuration file you want to edit. IOLAN configuration files saved in the DeviceManager can be in the IOLAN-native binary format (**.dme**) or as a text file (**.txt**), which can be edited with a text editor. Either configuration version can be imported into the DeviceManager. IOLAN configuration files saved from WebManager can also be opened into DeviceManager.

Importing an Existing Configuration File

If you have a local, saved configuration file that you want to download to the IOLAN, you must first connect to the IOLAN that you want to download the configuration file to. Once you have successfully logged into the IOLAN, in DeviceManager select **Tools, Import Configuration from a File** and in WebManager select **Administration, Restore/Backup**. You need to download the file in DeviceManager and in both managers you need to reboot the IOLAN.

Managing the IOLAN

Most of the management tasks, such as setting the time/date, downloading keys/certificates, downloading firmware, downloading custom files, resetting serial ports, etc., are found under the **Tools** menu option in the DeviceManager and under **Administration** in WebManager.

6

Configuring Serial Ports

Introduction

The Serial section is used to configure the serial ports on your IOLAN. The following configuration windows are available:

- **Serial Ports**—This window sets up the type of connection that the serial port is being used for. This is accomplished by selecting a connection profile and then configuring the applicable parameters for that profile. See [Serial Ports](#) for more information.
- **Advanced**—This window configures those parameters that are applicable to specific environments. You will find modem and TruePort configuration options, in addition to others, here.

See [Advanced](#) for more information.

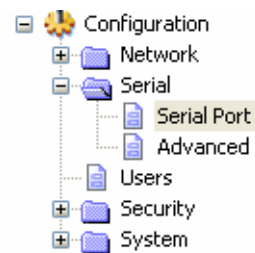

Serial Ports

Overview

Each IOLAN serial port can be connected to serial device. Each serial port can then be configured according to a serial port profile that coincides with the serial device attached to that serial port and how the serial device is accessed/used.

Functionality

When you select the **Serial Ports** navigation option, you will see a list with the number of serial ports on your IOLAN. As you configure the serial ports, the information for each serial port is displayed.

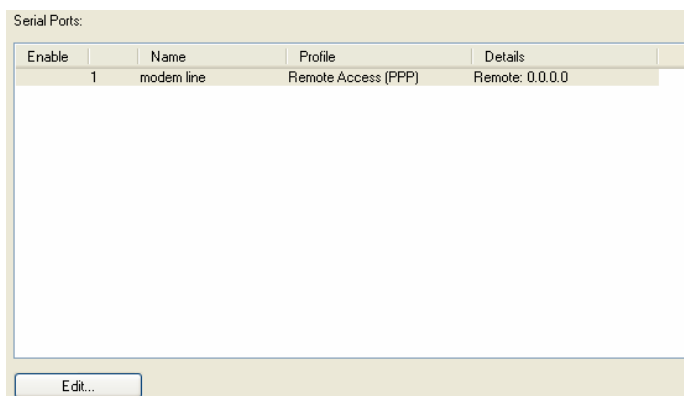

To configure/change a serial port, click the **Edit** button.

Editing a Serial Port

In the **Serial Port Settings** window, click on a serial port and then click the **Edit** button, the following window is displayed:

The screenshot shows the "Serial Port 1 Settings" dialog box. At the top, the profile is set to "Terminal" with a "Change Profile..." button. Below this is a "Name:" text field. The dialog has five tabs: "General", "Advanced", "Hardware", "Email Alert", and "Packet Forwarding". The "General" tab is active, showing "Terminal Settings". Under "Terminal Type", a dropdown menu is set to "Dumb". The "Require Login" radio button is selected, with a "User Service Settings..." button below it. The "Connect to remote system:" radio button is unselected. Under this option, there are three fields: "Protocol" (set to "Telnet" with a "Settings..." button), "Host name" (set to "None"), and "TCP Port" (set to "0"). At the bottom of the "Terminal Settings" section, there are three options for "Initiate Connection": "Automatically" (selected), "When any data is received", and "When 0d <CR> is received". At the bottom of the dialog box are "OK" and "Cancel" buttons.

Click the **Change Profile** button to select a different serial port profile if you don't want the displayed profile:

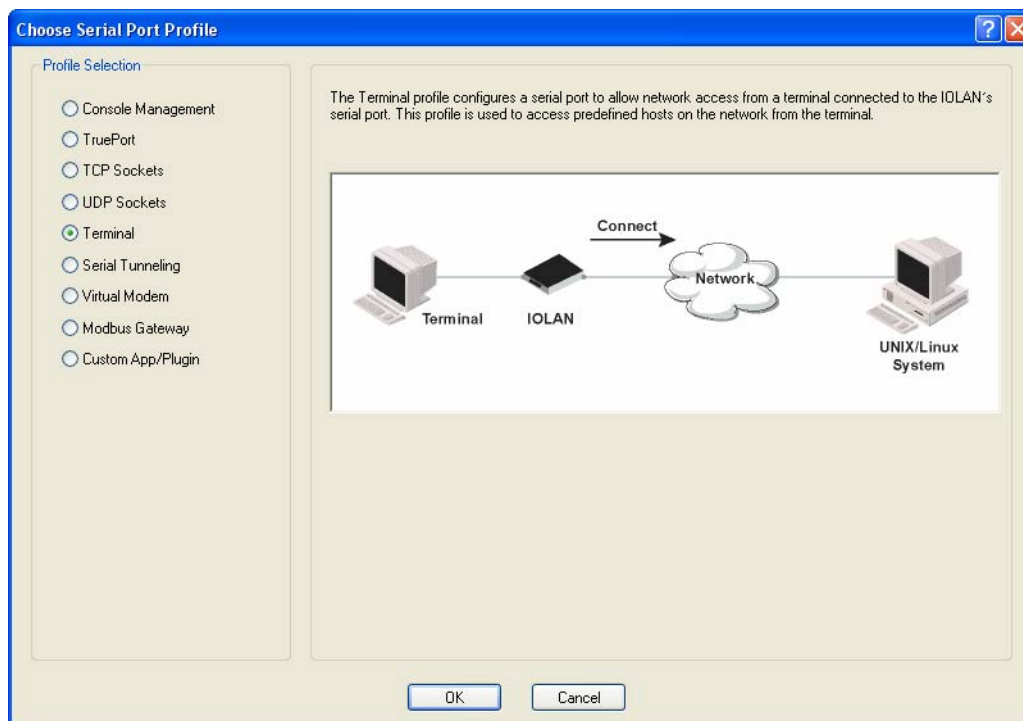

As you select the different serial port profiles, a short description and a picture representing a typical application of the profile is displayed. When you have selected the appropriate profile for the serial port, click **OK** and those serial port profile configuration options will be displayed.

Resetting a Serial Port

When you change a serial port's configuration, you can download the configuration file to the IOLAN and then reset a specific serial port(s) to see how you change affects the serial port's behavior. To reset a serial port, select **Tools, Reset, Serial Port(s)**.

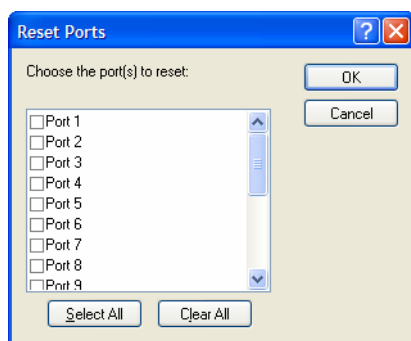

Serial Port Profiles

Common Tabs

Overview

There are several functions that are common to more than one profile. These functions are:

- **Hardware**—Configure the physical serial line parameters. See [Hardware Tab Field Descriptions](#).
- **Packet Forwarding**—Configure data packet parameters. See [Packet Forwarding Tab Field Descriptions](#).

Hardware Tab Field Descriptions

The **Hardware** tab configures all the serial port hardware connection information.

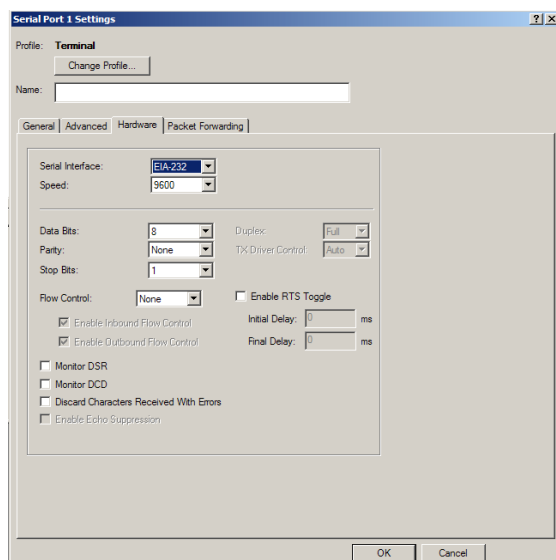

Configure the following parameters:

- Serial Interface** Specifies the type of serial line that is being used with the IOLAN.
Data Options: EIA-232, EIA-422, or EIA-485. TS2 models support only EIA-232.
Default: EIA-232
- Speed** Specifies the baud rate of the serial line; keep in mind that speed is affected by the length of the cable. You can also specify a custom baud rate. When you enter a custom baud rate, the IOLAN will calculate the closest baud rate available to the hardware. The exact baud rate calculated can be viewed in the **Serial Ports** statistics.
Range: 50-230400, custom supports 50-1843200
Default: 9600
- Data Bits** Specifies the number of bits in a transmitted character.
Default: 8

Parity	<p>Specifies the type of parity being used for the data communication on the serial port. If you want to force a parity type, you can specify Mark for 1 or Space for 0.</p> <p>Data Options: Even, Odd, Mark, Space, None</p> <p>Default: None</p>
Stop Bits	<p>Specifies the number of stop bits that follow a byte.</p> <p>Data Options: 1, 1.5, 2</p> <p>Default: 1</p>
Duplex	<p>Used with a EIA-485 serial interface, specify whether the serial port is Full Duplex (communication both ways at the same time) or Half Duplex (communication in one direction at a time).</p> <p>Default: Full</p>
TX Driver Control	<p>Used with a EIA-485 serial interface, if your application supports RTS (Request To Send), select this option. Otherwise, select Auto.</p> <p>Default: Auto</p>
Flow Control	<p>Defines whether the data flow is handled by the software (Soft), hardware (Hard), Both, or None.</p> <p>Data Options: Soft, Hard, Both, None</p> <p>Default: None</p>
EnableToggle RTS	<p>Configure the Toggle RTS Feature if your application needs for RTS to be raised during character transmission.</p> <p>Initial Delay: configure the time in (ms) between the time the RTS signal is raised and the start of character transmission. This delay only applies if this port is not running hardware flow control. If hardware flow control is used, the transmission will occur as soon as CTS is raised by the modem.</p> <p>Final Delay: configure the time (in ms) between the time of character transmission and when RTS is dropped.</p> <p>Initial delay range: 1-1000 ms</p> <p>Final delay range: 1-1000 ms</p> <p>Default: Off</p>
Enable Inbound Flow Control	<p>Determines if input flow control is to be used.</p> <p>Default: Enabled</p>
Enable Outbound Flow Control	<p>Determines if output flow control is to be used.</p> <p>Default: Enabled</p>
Monitor DSR	<p>Specifies whether the EIA-232 signal DSR (Data Set Ready) should be monitored. This is used with modems or any device that sends a DSR signal. When it is monitored and the IOLAN detects a DSR signal, the line profile is started. If both Monitor DCD and Monitor DSR are enabled, both signals must be detected before the line profile is started.</p> <p>Default: Disabled</p>
Monitor DCD	<p>Specifies whether the EIA-232 signal DCD (Data Carrier Detect) should be monitored. This is used with modems or any other device that sends a DCD signal. When it is monitored and the IOLAN detects a DCD signal, the line profile is started. If both Monitor DCD and Monitor DSR are enabled, both signals must be detected before the line profile is started.</p> <p>Default: Disabled</p>

- Enable Echo Suppression** This parameter applies only to **EIA-485 Half Duplex** mode. All characters will be echoed to the user and transmitted across the serial ports. Some EIA-485 applications require local echo to be enabled in order to monitor the loopback data to determine that line contention has occurred. If your application cannot handle loopback data, echo suppression should be enabled.
Default: Disabled
- Discard Characters Received with Line Errors** When enabled, the IOLAN will discard received characters with parity or framing errors.
Default: Disabled

Packet Forwarding Tab Field Descriptions

The **Packet Forwarding** tab can be used to control/define how and when data packets are sent from the IOLAN.

The screenshot shows the 'Packet Forwarding' configuration window. At the top, there are tabs for 'General', 'Advanced', 'Hardware', 'Email Alert', and 'Packet Forwarding'. The main text reads: 'Define the conditions under which data received on the serial port will be forwarded to the network.' There are three radio button options: 'Minimize Latency' (selected), 'Optimize Network Throughput', and 'Prevent Message Fragmentation'. Below these is a text input field for 'Delay Between Messages' with the value '250' and 'ms' to its right. Underneath is a section for 'Custom Packet Forwarding' with two sub-sections: 'Packet Definition' and 'Frame Definition'. 'Packet Definition' has five fields: 'Packet Size' (0), 'Idle Time' (0), 'Force Transmit Timer' (0), 'End Trigger1 Character' (0), and 'End Trigger2 Character' (0). 'Frame Definition' has five fields: 'SOF1 Character' (0), 'SOF2 Character' (0), 'Transmit SOF Character(s)' (checked), 'EOF1 Character' (0), and 'EOF2 Character' (0). At the bottom, there is a 'Trigger Forwarding Rule' dropdown menu set to 'Trigger'.

Configure the following parameters:

Minimize Latency This option ensures that all application data is immediately forwarded to the serial device and that every character received from the device is immediately sent on the network. Select this option for timing-sensitive applications.

Default: Enabled

Optimize Network Throughput This option provides optimal network usage while ensuring that the application performance is not compromised. Select this option when you want to minimize overall packet count, such as when the connection is over a WAN.

Default: Disabled

Prevent Message Fragmentation This option detects the message, packet, or data blocking characteristics of the serial data and preserves it throughout the communication. Select this option for message-based applications or serial devices that are sensitive to inter-character delays within these messages.

Default: Disabled

Delay Between Messages The minimum time, in milliseconds, between messages that must pass before the data is forwarded by the IOLAN.

Range: 0-65535

Default: 250 ms

Custom Packet Forwarding This option allows you to define the packet forwarding rules based on the packet definition or the frame definition.

Default: Disabled

Packet Definition	<p>When enabled, this group of parameters allows you to set a variety of packet definition options. The first criteria that is met causes the packet to be transmitted. For example, if you set a Force Transmit Timer of 1000 ms and a Packet Size of 100 bytes, whichever criteria is met first is what will cause the packet to be transmitted.</p> <p>Default: Enabled</p>
Packet Size	<p>The number of bytes that must be received from the serial port before the packet is transmitted to the network. A value of zero (0) ignores this parameter.</p> <p>Range: 0-1024 bytes</p> <p>Default: 0</p>
Idle Time	<p>The amount of time, in milliseconds, that must elapse between characters before the packet is transmitted to the network. A value of zero (0) ignores this parameter.</p> <p>Range: 0-65535 ms</p> <p>Default: 0</p>
Enable Trigger1 Character	<p>When enabled, specifies the character that when received will define when the packet is ready for transmission. The actual transmission of the packet is based on the Trigger Forwarding Rule.</p> <p>Range: Hex 0-FF</p> <p>Default: 0</p>
Enable Trigger2 Character	<p>When enabled, creates a sequence of characters that must be received to specify when the packet is ready for transmission (if the End Trigger1 character is not immediately followed by the End Trigger2 character, the IOLAN waits for another End Trigger1 character to start the End Trigger1/End Trigger2 character sequence). The actual transmission of the packet is based on the Trigger Forwarding Rule.</p> <p>Range: Hex 0-FF</p> <p>Default: 0</p>
Frame Definition	<p>When enabled, this group of parameters allows you to control the frame that is transmitted by defining the start and end of frame character(s). If the internal buffer (1024 bytes) is full before the EOF character(s) are received, the packet will be transmitted and the EOF character(s) search will continue.</p> <p>Default: Disabled</p>
SOF1 Character	<p>When enabled, the Start of Frame character defines the first character of the frame, any character(s) received before the Start of Frame character is ignored.</p> <p>Range: Hex 0-FF</p> <p>Default: 0</p>
SOF2 Character	<p>When enabled, creates a sequence of characters that must be received to create the start of the frame (if the SOF1 character is not immediately followed by the SOF2 character, the IOLAN waits for another SOF1 character to start the SOF1/SOF2 character sequence).</p> <p>Range: Hex 0-FF</p> <p>Default: 0</p>
Transmit SOF Character(s)	<p>When enabled, the SOF1 or SOF1/SOF2 characters will be transmitted with the frame. If not enabled, the SOF1 or SOF1/SOF2 characters will be stripped from the transmission.</p> <p>Default: Disabled</p>

- EOF1 Character** Specifies the End of Frame character, which defines when the frame is ready to be transmitted. The actual transmission of the frame is based on the Trigger Forwarding Rule.
Range: Hex 0-FF
Default: 0
- EOF2 Character** When enabled, creates a sequence of characters that must be received to define the end of the frame (if the EOF1 character is not immediately followed by the EOF2 character, the IOLAN waits for another EOF1 character to start the EOF1/EOF2 character sequence), which defines when the frame is ready to be transmitted. The actual transmission of the frame is based on the Trigger Forwarding Rule.
Range: Hex 0-FF
Default: 0
- Trigger Forwarding Rule** Determines what is included in the Frame (based on the EOF1 or EOF1/EOF2) or Packet (based on Trigger1 or Trigger1/Trigger2). Choose one of the following options:
- **Strip-Trigger**—Strips out the EOF1, EOF1/EOF2, Trigger1, or Trigger1/Trigger2, depending on your settings.
 - **Trigger**—Includes the EOF1, EOF1/EOF2, Trigger1, or Trigger1/Trigger2, depending on your settings.
 - **Trigger+1**—Includes the EOF1, EOF1/EOF2, Trigger1, or Trigger1/Trigger2, depending on your settings, plus the first byte that follows the trigger.
 - **Trigger+2**—Includes the EOF1, EOF1/EOF2, Trigger1, or Trigger1/Trigger2, depending on your settings, plus the next two bytes received after the trigger.
- Default:** Trigger

Console Management Profile

Overview

The Console Management profile provides access through the network to a console or administrative port of a server or router attached to the IOLAN's serial port. This profile configures the IOLAN's serial port to set up a TCP socket that will listen for a Telnet connection from the network.

Functionality

Use the Console Management profile when you are configuring users who need to access a serial console port from the network.

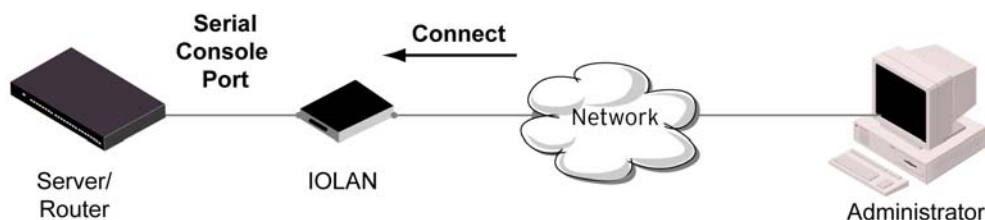

General Tab Field Descriptions

The **Console Management General** tab configures how the serial port will be accessed by the user through the network.

Configure the following parameters:

- | | |
|---|---|
| Protocol | Specify the connection method that users will use to communicate with a serial device connected to the IOLAN through the network.
Default: Telnet |
| Listen for Connections on TCP Port | The port number that the IOLAN will listen on for incoming TCP connections.
Default: 10001, depending on the serial port number |
| Enable IP Aliasing | Enables/disables the ability to access a serial device connected to the serial port by an IP address (or host name that can be resolved to the Internet IP Address in a DNS network) The IOLAN can also be accessed by an IP address and port number.
Default: Disabled |
| IP Address | Users can access serial devices connected to the IOLAN through the network by the specified Internet Address (or host name that can be resolved to the Internet Address in a DNS network).
Data Options: IPv4 Address |

Advanced Tab Field Descriptions

The **Console Management Advanced** tab configures serial port options that may be required by certain applications.

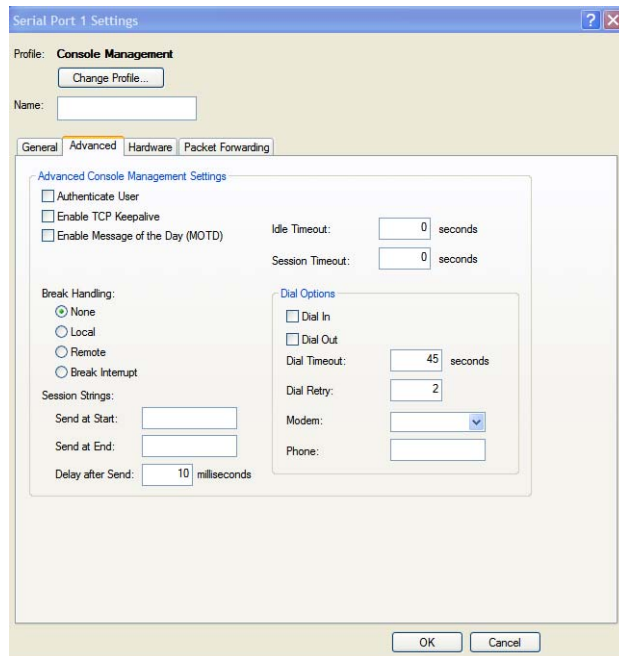

Configure the following parameters:

Authenticate User Enables/disables login/password authentication for users connecting from the network.

Default: Disabled

Enable TCP Keepalive

Enables a per-connection TCP keepalive feature. After the configured number of seconds, the connection will send a gratuitous ACK to the network peer, thus either ensuring the connection stays active OR causing a dropped connection condition to be recognized.

This parameter needs to be used in conjunction with **Monitor Connection Status Interval** parameter found in the **Serial, Advanced, Advanced Settings** tab. The interval determines how long the IOLAN will wait during inactivity before "testing" the connection. It should be noted that if a network connection is accidentally dropped, it can take as long as the specified interval before anyone can reconnect to the serial port.

Default: Disabled

Enable Message of the Day (MOTD) Enables/disables the display of the message of the day.

Default: Disabled

Idle Timeout

Use this timer to close a connection because of inactivity. When the **Idle Timeout** expires, the IOLAN will end the connection.

Default: 0 seconds so the port will never timeout

Range: 0-4294967 seconds (about 49 days)

Session Timeout	<p>Use this timer to forcibly close the session/connection when the Session Timeout expires.</p> <p>Default: 0 seconds so the port will never timeout</p> <p>Range: 0-4294967 seconds (about 49 days)</p>
Break Handling	<p>Specifies how a break is interpreted.</p> <p>Data Range:</p> <ul style="list-style-type: none">● None—The IOLAN ignores the break key completely and it is not passed through to the host.● Local—The IOLAN deals with the break locally. If the user is in a session, the break key has the same effect as a hot key.● Remote—When the break key is pressed, the IOLAN translates this into a telnet break signal which it sends to the host machine.● Break Interrupt—On some systems such as SunOS, XENIX, and AIX, a break received from the peripheral is not passed to the client properly. If the client wishes to make the break act like an interrupt key (for example, when the stty options -ignbrk and brkintr are set). <p>Default: None</p>
Session Strings	<p>Controls the sending of ASCII strings to serial devices at session start and session termination as follows;</p> <ul style="list-style-type: none">● Send at Start—If configured, this string will be sent to the serial device on power-up of the IOLAN or when a kill line command is issued on this serial port. If the "monitor DSR" or "monitor DCD" options are set the string will also be sent when the monitored signal is raised.● Range: 0-127 alpha-numeric characters. Non printable ascii characters must be entered in this format <027>. The decimal numbers within the brackets must be 3 digits long (example 003 not 3).● Send at End—If configured, this string will be sent to the serial device when the TCP session on the LAN is terminated. If multihost is configured, this string will only be sent to the serial device when the profile is configured as a listen mode connection and after all multihost connections are terminated. <p>Range: 0-127 alpha-numeric characters. Non printable ascii characters must be entered in this format <027>. The decimal numbers within the brackets must be 3 digits long (example 003 not 3).</p> <ul style="list-style-type: none">● Delay after Send—If configured, a delay time is sent to the device. This delay can be used to provide the serial device with time to process the string before the session is initiated. <p>Range: 0-65535 ms</p> <p>Default: 10 ms</p>
Dial In	<p>If the console port is remote and will be dialing in via modem or ISDN TA, enable this parameter.</p> <p>Default: Disabled</p>
Dial Out	<p>If you want the modem to dial a number when the serial port is started, enable this parameter.</p> <p>Default: Disabled</p>

Dial Timeout	The number of seconds the IOLAN will wait to establish a connection to a remote modem. Range: 1-99 Default: 45 seconds
Dial Retry	The number of times the IOLAN will attempt to re-establish a connection with a remote modem. Range: 0-99 Default: 2
Modem	The name of the predefined modem that is used on this line.
Phone	The phone number to use when Dial Out is enabled.

TruePort Profile

Overview

TruePort is COM Port redirector that is supplied with the IOLAN. TruePort can be installed as a client on a Workstation or Server and supports a variety of operating systems. It, in conjunction with the IOLAN, emulates a local serial port (COM port), to the application, to provide connectivity to a remote serial device over the network. The TruePort profile operates in conjunction with the TruePort software.

Functionality

TruePort is a COM port redirector utility for the IOLAN. It can be run in two modes (these modes will be set on the client software when it is configured):

- **TruePort Full mode**—This mode allows complete device control and operates as if the device was directly connected to the Workstation/Server's local serial port. It provides a complete COM port interface between the attached serial device and the network. All serial controls, baud rate control, etc., are sent to the IOLAN and replicated on its associated serial port.
- **TruePort Lite mode**—This mode provides a simple raw data interface between the application and the remote serial port. Although the port will still operate as a COM port, control signals are ignored. In this mode, the serial communications parameters must be configured on the IOLAN.

See the *TruePort User's Guide* for more details about the TruePort client software.

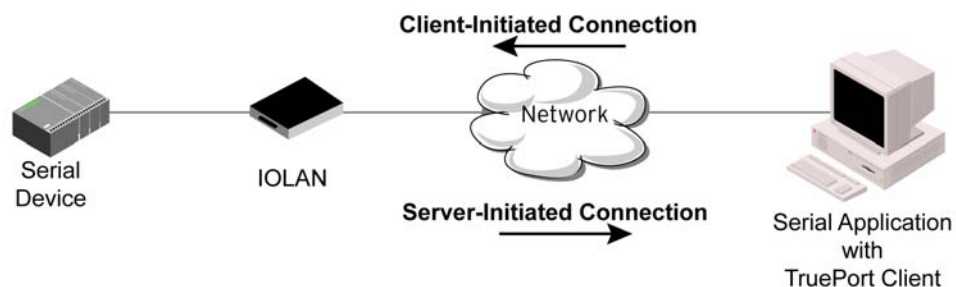

General Tab Field Descriptions

The **TruePort General** tab determines how the TruePort connection is initiated and then sets up the appropriate connection parameters.

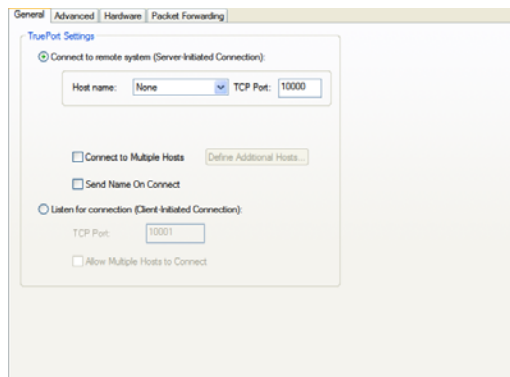

Configure the following parameters:

- Connect to remote system** When enabled, the IOLAN initiates communication to the TruePort client.
Default: Enabled
- Host Name** The configured host that the IOLAN will connect to (must be running TruePort).
Default: None
- TCP Port** The TCP Port that the IOLAN will use to communicate through to the TruePort client.
Default: 10001 for serial port 1, then increments by one for each serial port
- Connect to Multiple Hosts** When enabled, the IOLAN will establish a connection to multiple clients (Hosts). When using the multiple hosts feature, all TruePort clients must be running in Lite mode.
Default: Disabled
- Send Name on Connect** When enabled, the port name will be sent to the host upon session initiation.
Default: Disabled
- Define Additional Hosts Button** Click this button to define the hosts that this serial port will connect to. This button is also used to define the Primary/Backup host functionality.
See [Adding/Editing Additional TruePort Hosts](#) for more information.
- Listen for Connection** When enabled, the IOLAN will wait for connections to be initiated by the TruePort Client.
Default: Disabled
- TCP Port** The TCP Port that the IOLAN will use to communicate through to the TruePort client.
Default: 10001 for serial port 1, then increments by one for each serial port
- Allow Multiple Hosts to Connect** When this option is enabled, multiple hosts can connect to a serial device that is connected to this serial port. Note: These multiple clients (Hosts) need to be running TruePort in Lite mode.
Default: Disabled

Adding/Editing Additional TruePort Hosts

You can define a list of hosts that the serial device will communicate to through TruePort Lite or a primary/backup host.

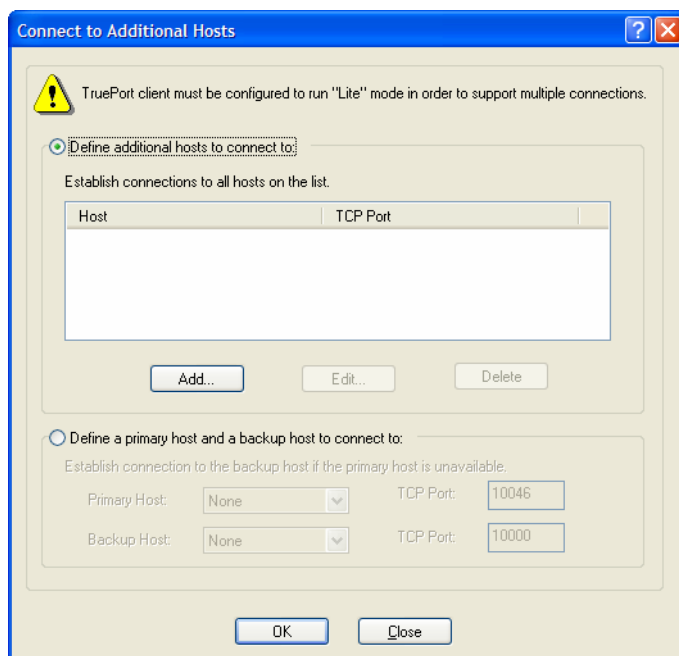

Configure the following parameters:

Define additional hosts to connect to When this option is enabled, you can define up to 49 hosts that the serial device connected to this serial port will attempt communicate to. With this mode of operation, the IOLAN will connect to multiple hosts simultaneously.

Default: Enabled

Add Button Click the **Add** button to add a host to the list of hosts that will be receiving communication from the serial device connected to the IOLAN.

See [Adding/Editing a Multihost Entry](#) for more information.

Edit Button Highlight an existing host and click the **Edit** button to edit a host in the list of hosts that will be receiving communication from the serial device connected to the IOLAN.

Delete Button Highlight an existing host and click the **Edit** button to edit a host in the list of hosts that will be receiving communication from the serial device connected to the IOLAN.

Define a primary host and backup... When this option is enabled, you need to define a primary host that the serial device connected to this serial port will communicate to and a backup host, in the event that the IOLAN loses communication to the primary host. The IOLAN will first establish a connection to the primary host. Should the connection to the primary host be lost (or never established), the IOLAN will establish a connection the backup host. Once connected to the backup, the IOLAN will attempt to re-establish a connection to the Primary host, once this is successfully done, it gracefully shuts down the backup connection.

Default: Disabled

Primary Host	Specify a preconfigured host that the serial device will communicate to through the IOLAN. Default: None
TCP Port	Specify the TCP port that the IOLAN will use to communicate to the Primary Host . Default: 0
Backup Host	Specify a preconfigured host that the serial device will communicate to through the IOLAN if the IOLAN cannot communicate with the Primary Host . Default: None
TCP Port	Specify the TCP port that the IOLAN will use to communicate to the Backup Host . Default: 10000

Adding/Editing a Multihost Entry

When you click the **Add** or **Edit** button, the Host Entry window appears. The hosts in the multihost list must already be defined. If you add a host that was defined with its fully qualified domain name (FQDN), it must be resolvable by your configured DNS server.

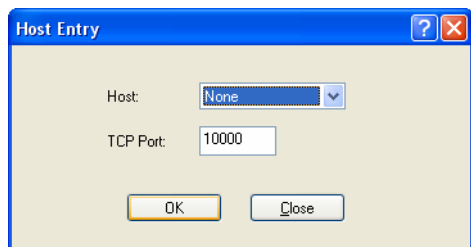

Configure the following parameters:

Host Name	Specify the preconfigured host that will be in the multihost list. Default: None
TCP Port	Specify the TCP port that the IOLAN will use to communicate to the Primary Host . Default: 10000 + serial port number - 1 (so serial port 2 defaults to 10001)

Advanced Tab Field Descriptions

The **TruePort Advanced** tab determines how the TruePort connection is initiated and then sets up the appropriate connection parameters.

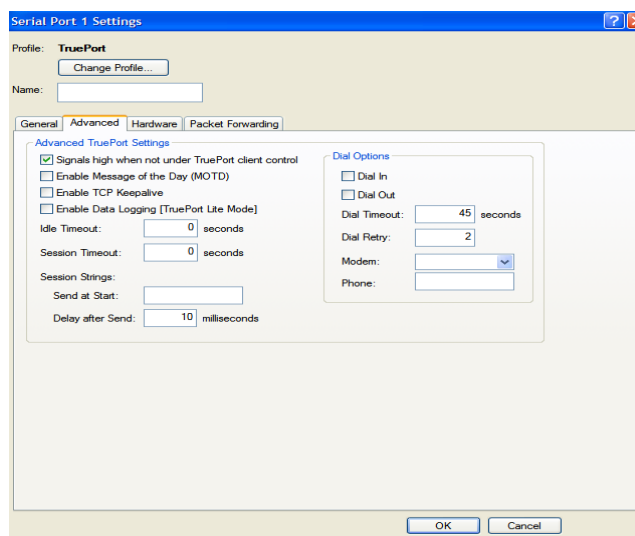

Configure the following parameters:

Signals high when...

This option has the following impact based on the state of the TruePort connection:

- **TruePort Lite Mode**—When enabled, the EIA-232 signals remain active before, during, and after the TruePort connection is established. When disabled, the EIA-232 signals remain inactive during and after the Trueport connection is established.
- **TruePort Full Mode**—When enabled, the EIA-232 signals remain active before and after the TruePort connection and the TruePort client will control the state of the signals during the established TruePort connection. When disabled, the EIA-232 signals remain inactive before and after the TruePort connection and the TruePort client will control the state of the signals during the established TruePort connection.

Default: Enabled

Enable Message of the Day (MOTD)

Enables/disables the display of the message of the day.

Default: Disabled

Enable TCP Keepalive

Enables a per-connection TCP keepalive feature. After the configured number of seconds, the connection will send a gratuitous ACK to the network peer, thus either ensuring the connection stays active OR causing a dropped connection condition to be recognized.

This parameter needs to be used in conjunction with **Monitor Connection Status Interval** parameter found in the **Serial, Advanced, Advanced Settings** tab. The interval determines how long the IOLAN will wait during inactivity before "testing" the connection. It should be noted that if a network connection is accidentally dropped, it can take as long as the specified interval before anyone can reconnect to the serial port.

Default: Disabled

Enable Data Logging [Trueport Lite Mode]	<p>When enabled, serial data will be buffered if the TCP connection is lost. When the TCP connection is re-established, the buffered serial data will be sent to its destination. Only valid in Trueport LITE mode. Not valid when using Trueport in Full Mode.</p> <p>The minimum data buffer size for all models is 1 KB. The maximum data buffer is 2000 KB for the DS1/TS2/STS8D, all other models are 4000 KB. If the data buffer is filled, incoming serial data will overwrite the oldest data.</p> <p>Note: A kill line or a reboot of the IOLAN causes all buffered data to be lost</p> <p>Values: 1-2000 KB (DS1/TS2/STS8D) - default is 4 KB Values: 1-4000 KB (all other models) - default is 256 KB</p> <p>Some profile features are not compatible Data Logging. See Data Logging for the complete list.</p> <p>To change the default buffer size see Advanced Serial Settings Tab.</p>
Idle Timeout	<p>Use this timer to close a connection because of inactivity. When the Idle Timeout expires, the IOLAN will end the connection.</p> <p>Default: 0 seconds so the port will never timeout Range: 0-4294967 seconds (about 49 days)</p>
Session Timeout	<p>Use this timer to forcibly close the session/connection when the Session Timeout expires.</p> <p>Default: 0 seconds so the port will never timeout Range: 0-4294967 seconds (about 49 days)</p>
Session Strings	<p>Controls the sending of ASCII strings to serial devices at session start as follows;</p> <ul style="list-style-type: none"> ● Send at Start—If configured, this string will be sent to the serial device on power-up of the IOLAN or when a kill line command is issued on this serial port. If the "monitor DSR" or "monitor DCD" options are set, the string will also be sent when the monitored signal is raised. Range: 0-127 alpha-numeric characters Range: Hexadecimal 0-FF ● Delay after Send—If configured, will inset a delay after the string is sent to the device. This delay can be used to provide the serial device with time to process the string before the session is initiated or terminated. Default: 10 ms
Dial In	<p>If the device is remote and will be dialing in via modem or ISDN TA, enable this parameter. Default: Disabled</p>
Dial Out	<p>If you want the modem to dial a number when the serial port is started, enable this parameter. Default: Disabled</p>
Dial Timeout	<p>The number of seconds the IOLAN will wait to establish a connection to a remote modem. Range: 1-99 Default: 45 seconds</p>

Dial Retry	The number of times the IOLAN will attempt to re-establish a connection with a remote modem. Range: 0-99 Default: 2
Modem	The name of the predefined modem that is used on this line.
Phone	The phone number to use when Dial Out is enabled.

TCP Sockets Profile

Overview

The TCP Socket profile allows for a serial device to communicate over a TCP network. The TCP connection can be initiated from a host on the network and/or a serial device. This is typically used with an application on a Workstation or Server that communicates to a device using a specific TCP socket. This is often referred to as a RAW connection.

Functionality

The **TCP Sockets** profile permits a raw connection to be established in either direction, meaning that the connection can be initiated by either the Workstation/Server or the IOLAN.

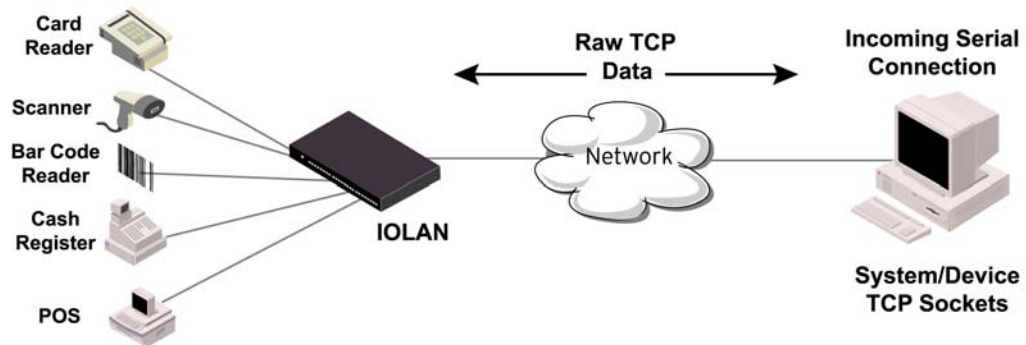

General Tab Field Descriptions

Serial Port 10 Settings

Profile: **TCP Sockets**

Name:

General | Advanced | Hardware | Email Alert | Packet Forwarding | SSL/TLS

TCP Socket Settings

Listen for connection:

TCP Port:

Allow Multiple Hosts to Connect

Enable IP Aliasing

IP Address:

Connect to:

Host name: TCP Port:

HTTP Tunnel:

Connect to Multiple Hosts

Initiate Connector:

Automatically

When any data is received

When is received

Send Name On Connect

Permit Connections in Both Directions

Configure the following parameters:

Listen for Connection

When enabled, the IOLAN listens for a connection to be established by the Workstation/Server on the network.

Default: Enabled

TCP Port	The TCP port that the IOLAN will use to listen for incoming connections. Default: 10000 plus the serial port number, so serial port 2 would have a default of 10002
Allow Multiple Hosts to Connect	When this option is enabled, multiple hosts can connect to the serial device that is connected to this serial port. Default: Disabled
Enable IP Aliasing	Enables/disables the ability to access a serial device connected to the serial port by an IP address (or host name that can be resolved to the Internet IP Address in a DNS network) The IOLAN can also be accessed by an IP address and port number. Default: Disabled
Connect To	When enabled, the IOLAN initiates communication to the Workstation/Server. Default: Disabled
Host Name	The configured host that the IOLAN will connect to.
TCP Port	The TCP Port that the IOLAN will use to communicate to the client. Default: 0
Connect to Multiple Hosts	When enabled, allows a serial device connected to this serial port to communicate to multiple hosts. Default: Disabled
Define Additional Hosts Button	Click this button to define the hosts that this serial port will connect to. This button is also used to define the Primary/Backup host functionality.
Initiate Connection Automatically	If the serial port hardware parameters have been setup to monitor DSR or DCD, the host session will be started once the signals are detected. If no hardware signals are being monitored, the IOLAN will initiate the session immediately after being powered up. Default: Enabled
Initiate Connection When any data is received	Initiates a connection to the specified host when any data is received on the serial port. Default: Disabled
Initiate Connection When <hex value> is received	Initiates a connection to the specified host only when the specified character is received on the serial port. Default: Disabled
Send Name on Connect	When enabled, the port name will be sent to the host upon session initiation. This will be done before any other data is sent or received to/from the host Default: Disabled
Permit Connections in Both Directions	When this option is enabled, you can select both checkbox options "listen for connection" and "connect to". Default: Disabled

Adding/Editing Additional Hosts

You can define a list of hosts that the serial device will communicate to or a primary/backup host.

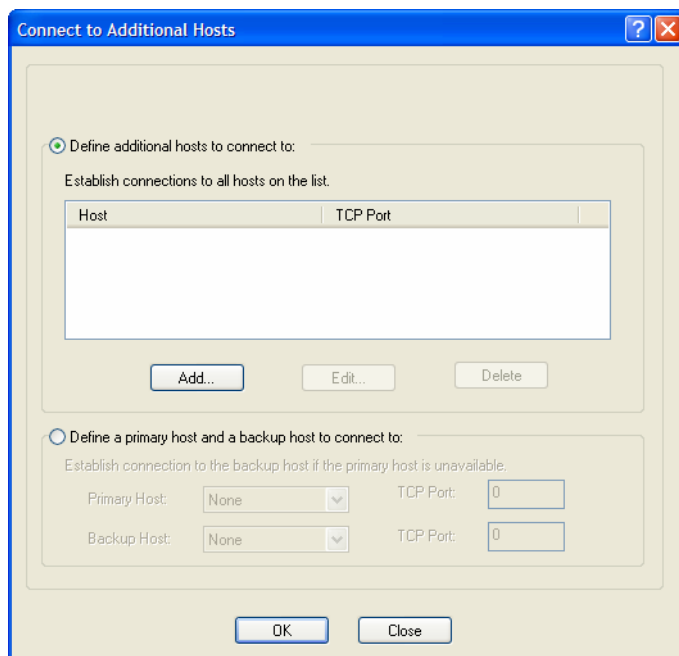

Configure the following parameters:

Define additional hosts to connect to When this option is enabled, you can define up to 49 hosts that the serial device connected to this serial port will attempt communicate to. With this mode of operation, the IOLAN will connect to multiple hosts simultaneously.

Default: Enabled

Add Button Click the **Add** button to add a host to the list of hosts that will be receiving communication from the serial device connected to the IOLAN.

Edit Button Highlight an existing host and click the **Edit** button to edit a host in the list of hosts that will be receiving communication from the serial device connected to the IOLAN.

Delete Button Click the **Delete** button to delete a host to the list of hosts that will be receiving communication from the serial device connected to the IOLAN.

Define a primary host and backup... When this option is enabled, you need to define a primary host that the serial device connected to this serial port will communicate to and a backup host, in the event that the IOLAN loses communication to the primary host. The IOLAN will first establish a connection to the primary host. Should the connection to the primary host be lost (or never established), the IOLAN will establish a connection the backup host. Once connected to the backup, the IOLAN will attempt to re-establish a connection to the Primary host, once this is successfully done, it gracefully shuts down the backup connection.

Default: Disabled

Primary Host Specify a preconfigured host that the serial device will communicate to through the IOLAN.

Default: None

TCP Port	Specify the TCP port that the IOLAN will use to communicate to the Primary Host . Default: 0
Backup Host	Specify a preconfigured host that the serial device will communicate to through the IOLAN if the IOLAN cannot communicate with the Primary Host . Default: None
TCP Port	Specify the TCP port that the IOLAN will use to communicate to the Backup Host . Default: 10000

Adding/Editing a Multihost Entry

When you click the **Add** or **Edit** button, the Host Entry window appears. The hosts in the multihost list must already be defined (see [Host Table](#) to learn how to create a host). If you add a host that was defined with its fully qualified domain name (FQDN), it must be resolvable by your configured DNS server.

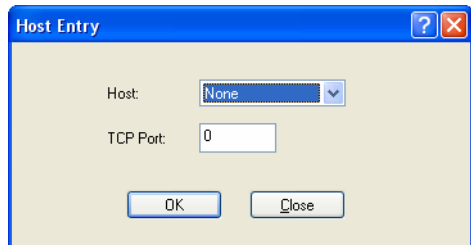

Configure the following parameters:

Host Name	Specify the preconfigured host that will be in the multihost list. Default: None
TCP Port	Specify the TCP port that the IOLAN will use to communicate to the Host . Default: 0

Advanced Tab Field Descriptions

Configure the following parameters:

Authenticate User Enables/disables login/password authentication for users connecting from the network.

Default: Disabled

Enable TCP Keepalive Enables a per-connection TCP keepalive feature. After the configured number of seconds, the connection will send a gratuitous ACK to the network peer, thus either ensuring the connection stays active OR causing a dropped connection condition to be recognized.

This parameter needs to be used in conjunction with **Monitor Connection Status Interval** parameter found in the **Serial, Advanced, Advanced Settings** tab. The interval determines how long the IOLAN will wait during inactivity before "testing" the connection. It should be noted that if a network connection is accidentally dropped, it can take as long as the specified interval before anyone can reconnect to the serial port.

Default: Disabled

Enable Message of the Day (MOTD) Enables/disables the display of the message of the day.

Default: Disabled

Enable Data Logging When enabled, serial data will be buffered if the TCP connection is lost. When the TCP connection is re-established, the buffered serial data will be sent to its destination. The minimum data buffer size for all models is 1 KB. The maximum data buffer is 2000 KB for the DS1/TS2/STS8D, all other models are 4000 KB. If the data buffer is filled, incoming serial data will overwrite the oldest data.

Note: A kill line or a reboot of the IOLAN causes all buffered data to be lost

Values: 1-2000 KB (DS1/TS2/STS8D) - default is 4 KB

Values: 1-4000 KB (all other models) - default is 256 KB

Some profile features are not compatible with Data Logging. See [Data Logging](#) for the complete list.

To change the default buffer size see [Advanced Serial Settings Tab](#).

Idle Timeout	<p>Use this timer to close a connection because of inactivity. When the Idle Timeout expires, the IOLAN will end the connection.</p> <p>Default: 0 seconds so the port will never timeout</p> <p>Range: 0-4294967 seconds (about 49 days)</p>
Session Timeout	<p>Use this timer to forcibly close the session/connection when the Session Timeout expires.</p> <p>Default: 0 seconds so the port will never timeout</p> <p>Range: 0-4294967 seconds (about 49 days)</p>
Sessions Strings	<p>Controls the sending of ASCII strings to serial devices at session start and session termination as follows;</p> <ul style="list-style-type: none">● Send at Start—If configured, this string will be sent to the serial device on power-up of the IOLAN or when a kill line command is issued on this serial port. If the "monitor DSR" or "monitor DCD" options are set the string will also be sent when the monitored signal is raised.● Range: 0-127 alpha-numeric characters. Non printable ascii characters must be entered in this format <027>. The decimal numbers within the brackets must be 3 digits long (example 003 not 3).● Send at End—If configured, this string will be sent to the serial device when the TCP session on the LAN is terminated. If multihost is configured, this string will only be sent to the serial device when the profile is configured as a listen mode connection and after all multihost connections are terminated. <p>Range: 0-127 alpha-numeric characters. Non printable ascii characters must be entered in this format <027>. The decimal numbers within the brackets must be 3 digits long (example 003 not 3).</p> <ul style="list-style-type: none">● Delay after Send—If configured, a delay time is sent to the device. This delay can be used to provide the serial device with time to process the string before the session is initiated. <p>Range: 0-65535 ms</p> <p>Default: 10 ms</p>
Dial In	<p>If the device is remote and will be dialing in via modem or ISDN TA, enable this parameter.</p> <p>Default: Disabled</p>
Dial Out	<p>If you want the modem to dial a number when the serial port is started, enable this parameter.</p> <p>Default: Disabled</p>
Dial Timeout	<p>The number of seconds the IOLAN will wait to establish a connection to a remote modem.</p> <p>Range: 1-99</p> <p>Default: 45 seconds</p>
Dial Retry	<p>The number of times the IOLAN will attempt to re-establish a connection with a remote modem.</p> <p>Range: 0-99</p> <p>Default: 2</p>
Modem	<p>The name of the predefined modem that is used on this line.</p>
Phone	<p>The phone number to use when Dial Out is enabled.</p>

UDP Sockets Profile

Overview

The UDP profile configures a serial port to send or receive data to/from the LAN using the UDP protocol.

Functionality

You can use UDP profile in the following two basic modes. The first is to send data coming from the serial device to one or more UDP listeners on the LAN. The second is to accept UDP datagrams coming from one or more UDP senders on the LAN and forward this data to the serial device. You can also configure a combination of both which will allow you to send and receive UDP data to/from the LAN.

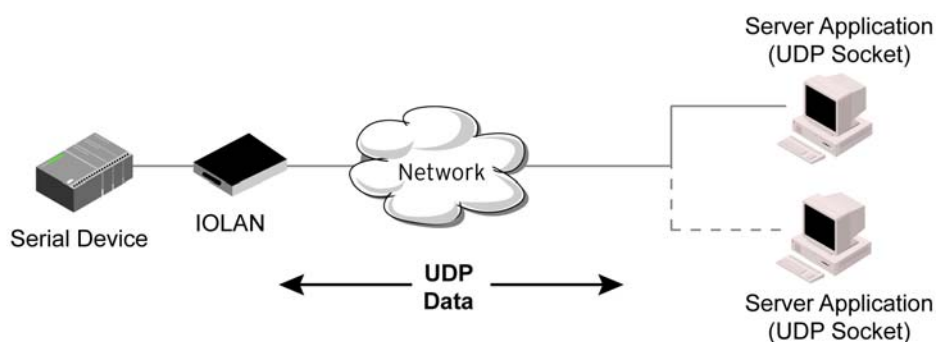

Sample **UDP Sockets** configuration screen

UDP Socket Settings

Listen for connections on UDP port:

Host Range

	Direction	Start IP Address	End IP Address	UDP Port
1	Both	0.0.0.0	0.0.0.0	Auto Learn
2	Disabled	0.0.0.0	0.0.0.0	Auto Learn
3	Disabled	0.0.0.0	0.0.0.0	Auto Learn
4	Disabled	0.0.0.0	0.0.0.0	Auto Learn

Four individual entries are provided to allow you greater flexibility to specify how data will be forwarded to/from the serial device. All four entries support the same configuration parameters. You can configure one or more of the entries as needed.

The first thing you need to configure for an entry is the “**Direction**” of the data flow. The following options are available;

- **Disabled** - UDP service not enabled.
- **LAN to Serial** - This setting will allow UDP data to be received from one or more hosts on the LAN and forwarded to the serial device attached to this serial port.
- **Serial to LAN** - This setting will allow data originating from the serial device attached to this serial port to be sent to one or more hosts on the LAN using UDP datagrams.

- **Both** - Allows for data to flow from the serial device to the LAN and from the LAN to the serial device.

The role of each of the configurable parameters in an entry depends on the “**Direction**” selected.

When the direction is "**LAN to Serial**" the role of the additional parameters is as follow;

- **Start IP Address** - This is the IP address of the host from which the UDP data will originate. If the data will originate from a number of hosts, this becomes the starting IP address of a range.
- **End IP Address** - If you wish to receive data only from the single host defined by "Start IP address", leave this entry as is (0.0.0.0). If you wish to accept data from a number of hosts, this address will represent the upper end of a range starting from "Start IP Address". Only data originating from this range will be forwarded to the serial port.
- **UDP port** - This is the UDP port from which the data will originate. There are three options for this parameter.
 - **Auto Learn** - The first UDP message received will be used to define which UDP port we are going to accept UDP data from. Once learned, only data from this UDP port will be accepted. The data must also originate from a host which is in the IP range defined for this entry.
 - **Any Port** - Any UDP port will be accepted as long as the data originates from a host in the IP range defined for this entry.
 - **Port** - Only data originating from the UDP port configured here as well as originating from a host in the IP range defined for this entry will be accepted.

When the direction is "**Serial to LAN**" the role of the additional parameters is as follow;

- **Start IP Address** - This is the IP address of the host to which the serial data will be sent using UDP datagrams. If the serial data is to be sent to more than one host, this becomes the starting IP address of a range.
- **End IP Address** - If you wish to send serial data to a single host, leave this entry as is (0.0.0.0). If you wish to send the serial data to a number of hosts, this address will represent the upper end of a range starting from "Start IP Address".
- **UDP port** - This is the UDP port to which the serial data will be forwarded. For a direction of "Serial to LAN", you must specify the port to be used.

When the direction is "**Both**" the role of the additional parameters is as follow;

- **Start IP Address** - This is the IP address of the host to which the serial data will be sent using UDP datagrams. It is also the IP address of the host from which UDP data coming from the LAN will be accepted from. If the data is to be sent to or received from more than one host, this becomes the starting IP address of a range.
- **End IP Address** - If you wish to send serial data to a single host and only receive data from the single UDP host, leave this entry as is (0.0.0.0). If the data is to be sent to or received from more than one host, this address will represent the upper end of a range starting from "Start IP Address". Only data originating from this range will be forwarded to the serial port.
- **UDP Port** - This is the UDP port to which the serial data will be forwarded as well as the UDP port from which data originating on the LAN will be accepted from. For a direction of "Both", there are two valid option for the UDP Port as follows;
 - **Auto Learn** - The first UDP message received will be used to define which port we are going to accept UDP data from. Once learned, only data from this UDP port will be accepted and serial data being forwarded to the LAN will be sent to this UDP port. Until the port is learned, data from the serial port intended to be sent to the LAN will be discarded.

- **Port** - Serial data being forwarded to the LAN from the serial device will sent to this UDP port. Only data originating from the UDP port configured here (as well as originating from a host in the IP range defined for this entry) will be forwarded to the serial device.

Special values for "Start IP address"

- **0.0.0.0** - This is the "auto learn IP address" value which is valid only in conjunction with the "LAN to Serial" setting. The first UDP packet received for this serial port will set the IP address from which we will accept future UDP packets to be forwarded to the serial port. For this setting, leave the "End IP Address" as 0.0.0.0.
- **255.255.255.255** - This selection is only valid in conjunction with the "LAN to Serial" setting. It will accept all UDP packets received for this serial port regardless of the originating IP address. For this setting, leave the "End IP Address" as 0.0.0.0.
- **Subnet directed broadcast** - You can use the "Start IP Address" field to enter a subnet directed broadcast address. This is done by specifying the subnet address with the host portion filled with 1s. For example, if you are on the subnet 172.16.x.x with a subnet mask of 255.255.254.0 than you would specify an IP address of 172.16.1.255 (all ones for host portion). For this setting, leave the "End IP Address" as 0.0.0.0. For any "LAN to Serial" ranges you have defined for this serial port, you must ensure that IP address of this IOLAN is not included in the range. If your IP address is within the range, you will receive the data you send via the subnet directed broadcasts as data coming in from the LAN.

An example UDP configuration is described based on the following window.

Direction	Start IP Address	End IP Address	UDP Port
1 LAN to Serial	172.16.1.25	172.16.1.50	Port 33010
2 Serial to LAN	172.16.1.75	172.16.1.80	Port 33009
3 Both	172.16.1.1	172.16.1.20	Port 33001
4 Disabled	0.0.0.0	0.0.0.0	Auto Learn 0

The UDP configuration window, taken from the DeviceManager, is configured to:

- **UDP Entry 1**
All UDP data received from hosts that have an IP address that falls within the range of **172.16.1.25** to **172.16.1.50** and source UDP **Port** of **33010** will be sent to the serial device. The IOLAN will not send any data received on its serial port to the host range defined by this entry.
- **UDP Entry 2**
All hosts that have an IP Address that falls within the range of **172.16.1.75** to **172.16.1.80** and who listen to UDP **Port 33009** will receive UDP data from the serial device. No UDP data originating from the hosts defined by this entry will be forwarded to the serial device.
- **UDP Entry 3**
All hosts that have an IP address that falls within the range of **172.16.1.1** to **172.16.1.20** and listen to **Port 33001** will be sent the data from the serial device in UDP format. The serial device will only receive UDP data from the hosts in that range with a source UDP **Port** of **33001**. The IOLAN will listen for data on the port value configured in the **Listen for connections on UDP port** parameter. (10001 in above example)
- **UDP Entry 4**

This entry is disabled since **Direction** is set to **Disabled**.

General Tab Field Descriptions

Host Range	Direction	Start IP Address	End IP Address	UDP Port
1	Both	0.0.0.0	0.0.0.0	Auto Learn
2	Disabled	0.0.0.0	0.0.0.0	Auto Learn
3	Disabled	0.0.0.0	0.0.0.0	Auto Learn
4	Disabled	0.0.0.0	0.0.0.0	Auto Learn

Configure the following parameters:

Listen for connections on UDP port

The IOLAN will listen for UDP packets on the specified port.

Default: 1000+<port-number> (for example, 10001 for serial port 1)

Direction

The direction in which information is received or relayed:

The direction in which information is received or relayed:

- **Disabled**—UDP service not enabled.
- **LAN to Serial**—**UDP Port** can be set to **Auto Learn** or **Port**. The IOLAN will listen on port value configured in the **Listen for connections on UDP port** parameter for messages coming from the learned or configured port.
- **Serial to LAN**—**UDP Port** can be set to **Port** only. The IOLAN will listen on the port value configured in the **Listen for connections on UDP port** parameter and will send to the configured port.
- **Both**—Messages are relayed in both directions. **UDP Port** can be set to **Auto Learn** or **Port**. For messages coming from the LAN to the serial device, IOLAN will listen on port value configured in the **Listen for connections on UDP port** parameter for messages coming from the learned or configured port. For messages going from the serial device to the LAN, the IOLAN will listen on the port value configured in the **Listen for connections on UDP port** parameter and will send to the configured or learned (if **Auto Learn** is enabled, the IOLAN must receive a UDP message before it can send one, since the port must first be ('learned') port.
- **Default:** Both for UDP 1 and Disabled for all other UDP ranges

Start IP Address

The first host IP address in the range of IP addresses (for IPv4 or IPv6) that the IOLAN will listen for messages from and/or send messages to.

Field Format: IPv4 or IPv6 address

End IP Address

The last host IP address in the range of IP addresses (for IPv4, not supported for IPv6) that the IOLAN will listen for messages from and/or send messages to.

Field Format: IPv4 address

UDP Port	<p>Determines how the IOLAN's UDP port that will send/receive UDP messages is defined:</p> <ul style="list-style-type: none"> ● Auto Learn—The IOLAN will only listen to the first port that it receives a UDP packet from. Applicable when Direction is set to LAN to Serial or Both. ● Any Port—The IOLAN will receive messages from any port sending UDP packets. Applicable when Direction is set to LAN to Serial. ● Port—The port that the IOLAN will use to relay messages to servers/hosts. This option works with any Direction except Disabled. The IOLAN will listen for UDP packets on the port configured by the Listen for connections on UDP port parameter. <p>Default: Auto Learn</p>
Port	<p>The UDP port to use.</p> <p>Default: 0 (zero)</p>

Advanced Tab Field Descriptions

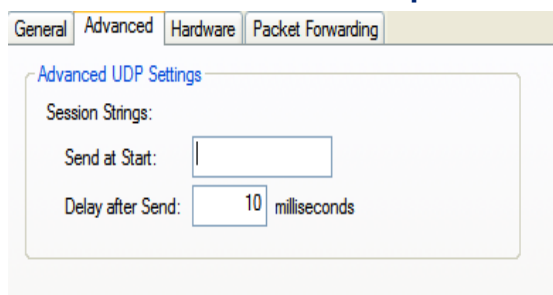

Configure the following parameters:

Session Strings	<p>Controls the sending of ASCII strings to serial devices at session start as follows;</p> <ul style="list-style-type: none"> ● Send at Start—If configured, this string will be sent to the serial device on power-up of the IOLAN or when a kill line command is issued on the serial port. If the "monitor DSR" or "monitor DCD" options are set, the string will also be sent when the monitored signal is raised. <ul style="list-style-type: none"> Range: 0-127 alpha-numeric characters Range: Hexadecimal 0-FF ● Delay after Send—If configured, will inset a delay after the string is sent to the device. This delay can be used to provide the serial device with time to process the string before the session is initiated or terminated. <ul style="list-style-type: none"> Default: 10 ms
------------------------	--

Terminal Profile

Overview

The Terminal profile allows network access from a terminal connected to the IOLAN's serial port. This profile is used to access pre-defined hosts on the network from the terminal.

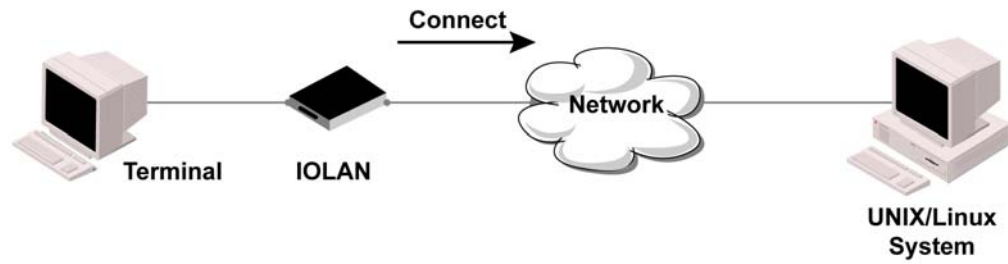

Functionality

This profile can be setup in two ways:

1. The user can be required to log into the IOLAN and then a connection to a host can be established.
2. The user connecting to the serial port will be directly connected a host.

General Tab Field Descriptions

The screenshot shows a configuration window with four tabs: General, Advanced, Hardware, and Packet Forwarding. The 'General' tab is selected. Under 'Terminal Settings', the 'Terminal Type' is set to 'Dumb'. The 'Require Login' radio button is selected, with a 'User Service Settings...' button below it. The 'Connect to remote system:' radio button is unselected. Under this section, 'Protocol' is set to 'Telnet' with a 'Settings...' button, 'Host name' is set to 'None', and 'TCP Port' is set to '0'. The 'Initiate Connection:' section has three options: 'Automatically' (selected), 'When any data is received', and 'When 0d <CR> is received'.

Configure the following parameters:

Terminal Type	<p>Specifies the type of terminal connected to the line.</p> <p>Data Options:</p> <ul style="list-style-type: none"> ● Dumb ● WYSE60 ● VT100 ● ANSI ● TVI925 ● IBM3151TE ● VT320 (specifically supporting VT320-7) ● HP700 (specifically supporting HP700/44) ● Term1, Term2, Term3 (user-defined terminals) <p>Default: Dumb</p>
Require Login	<p>When users access the IOLAN through the serial port, they must be authenticated using the local user database.</p> <p>Default: Enabled</p>
User Service Settings Button	<p>After a user has been successfully authenticated, the IOLAN will connect to the specified host using the specified protocol according to:</p> <ul style="list-style-type: none"> ● the User Service parameter for locally configured users ● the Default User Service parameter for users who are externally authenticated <p>See User Service Settings for field descriptions of the various User Service Settings.</p>
Connect to Remote System	<p>When the serial port is started, the IOLAN will initiate a connection to the specified host using the specified protocol. With this option, user authentication will not be performed by the IOLAN.</p> <p>Default: Disabled</p>
Protocol	<p>Specify the protocol that will be used to connect to the specified host.</p> <p>Default: Telnet</p>
Settings Button	<p>Click this button to define the settings for the protocol that will be used to connect the user to the specified host.</p>
Host Name	<p>The configured host that the IOLAN will connect to.</p>
TCP Port	<p>The TCP Port that the IOLAN will use to connect to the host.</p> <p>Default: 23</p>
Automatically	<p>If the serial port hardware parameters have been setup to monitor DSR or DCD, the host session will be started once the signals are detected. If no hardware signals are being monitored, the IOLAN will initiate the session immediately after being powered up.</p> <p>Default: Enabled</p>
When any data is received	<p>Initiates a connection to the specified host when any data is received on the serial port.</p> <p>Default: Disabled</p>

When <hex value> is received Initiates a connection to the specified host only when the specified character is received on the serial port.

Default: Disabled

Advanced Tab Field Descriptions

Configure the following parameters:

Enable Message of the Day (MOTD) Enables/disables the display of the message of the day.

Default: Disabled

Reset Terminal on disconnect When enabled, resets the terminal definition connected to the serial port when a user logs out.

Default: Disabled

Allow Port Locking When enabled, the user can lock his terminal with a password using the **Hotkey Prefix** (default Ctrl-a) **^a l** (lowercase L). The IOLAN prompts the user for a password and a confirmation.

Default: Disabled

Hotkey Prefix	<p>The prefix that a user types to lock a serial port or redraw the Menu.</p> <p>Data Range:</p> <ul style="list-style-type: none"> ● ^a l—(Lowercase L) Locks the serial port until the user unlocks it. The user is prompted for a password (any password, excluding spaces) and locks the serial port. Next, the user must retype the password to unlock the serial port. ● ^r—When you switch from a session back to the Menu, the screen may not be redrawn correctly. If this happens, use this command to redraw it properly. This is always Ctrl R, regardless of the Hotkey Prefix. <p>You can use the Hotkey Prefix key to lock a serial port only when the Allow Port Locking parameter is enabled.</p> <p>Default: Hex 01 (Ctrl-a, ^a)</p>
Idle Timeout	<p>Use this timer to close a connection because of inactivity. When the Idle Timeout expires, the IOLAN will end the connection.</p> <p>Default: 0 seconds so the port will never timeout</p> <p>Range: 0-4294967 seconds (about 49 days)</p>
Session Timeout	<p>Use this timer to forcibly close the session/connection when the Session Timeout expires.</p> <p>Default: 0 seconds so the port will never timeout</p> <p>Range: 0-4294967 seconds (about 49 days)</p>
Session Strings	<p>Controls the sending of ASCII strings to serial devices at session start as follows;</p> <ul style="list-style-type: none"> ● Send at Start—If configured, this string will be sent to the serial device on power-up of the IOLAN or when a kill line command is issued on this serial port. If the "monitor DSR" or "monitor DCD" options are set, the string will also be sent when the monitored signal is raised. <ul style="list-style-type: none"> Range: 0-127 alpha-numeric characters Range: Hexadecimal 0-FF ● Delay after Send—If configured, will inset a delay after the string is sent to the device. This delay can be used to provide the serial device with time to process the string before the session is initiated or terminated. <ul style="list-style-type: none"> Default: 10 ms
Dial Timeout	<p>The number of seconds the IOLAN will wait to establish a connection to a remote modem.</p> <p>Range: 1-99</p> <p>Default: 45 seconds</p>
Dial Retry	<p>The number of times the IOLAN will attempt to re-establish a connection with a remote modem.</p> <p>Range: 0-99</p> <p>Default: 2</p>
Dial In	<p>If the device is remote and will be dialing in via modem or ISDN TA, enable this parameter.</p> <p>Default: Disabled</p>
Dial Out	<p>If you want the modem to dial a number when the serial port is started, enable this parameter.</p> <p>Default: Disabled</p>

User Service Settings

Login Settings

These settings apply to users who are accessing the network from a terminal connected to the IOLAN's serial port. The Telnet settings take effect when the connection method is defined in the user's profile.

Configure the following parameters:

- | | |
|---------------------------------|--|
| Limit Connection to User | Makes the serial port dedicated to the specified user. The user won't need to enter their login name - just their password. |
| Initial Mode | Specifies the initial interface a user navigates when logging into the serial port.
Data Options: Menu, Command Line
Default: Command Line |
| Terminal Pages | The number of video pages the terminal supports.
Range: 1-7
Default: 5 pages |

Telnet Settings

The Telnet settings apply when the **User Service** is set to **Telnet** or the Terminal profile specifies a **Telnet** connection to a host.

Configure the following parameters:

- Terminal Type** Type of terminal attached to this serial port; for example, ANSI or WYSE60.
- Enable Local Echo** Toggles between local echo of entered characters and suppressing local echo. Local echo is used for normal processing, while suppressing the echo is convenient for entering text that should not be displayed on the screen, such as passwords. This parameter can be used only when **Enable Line Mode** is enabled.
Default: Disabled
- Enable Line Mode** When enabled, keyboard input is not sent to the remote host until **Enter** is pressed, otherwise input is sent every time a key is pressed.
Default: Disabled
- Map CR to CRLF** When enabled, maps carriage returns (CR) to carriage return line feed (CRLF).
Default: Disabled
- Interrupt** Defines the interrupt character. Typing the interrupt character interrupts the current process. This value is in hexadecimal.
Default: 3 (ASCII value **^C**)
- Quit** Defines the quit character. Typing the quit character closes and exits the current telnet session. This value is in hexadecimal.
Default: 1c (ASCII value **FS**)
- EOF** Defines the end-of-file character. When **Enable Line Mode** is enabled, entering the EOF character as the first character on a line sends the character to the remote host. This value is in hexadecimal.
Default: 4 (ASCII value **^D**)
- Erase** Defines the erase character. When **Line Mode** is **Off**, typing the erase character erases one character. This value is in hexadecimal.
Default: 8 (ASCII value **^H**)
- Echo** Defines the echo character. When **Line Mode** is **On**, typing the echo character echoes the text locally and sends only completed lines to the host. This value is in hexadecimal.
Default: 5 (ASCII value **^E**)

Escape	Defines the escape character. Returns you to the command line mode. This value is in hexadecimal. Default: 1d (ASCII value GS)
---------------	--

Serial Tunneling Profile

Overview

The Serial Tunneling profile allows two IOLANs to be connected back-to-back over the network to establish a virtual link between two serial ports based on RFC 2217.

Functionality

The serial device that initiates the connection is the **Tunnel Client** and the destination is the **Tunnel Server**, although once the serial communication tunnel has been successfully established, communication can go both ways.



A more detailed implementation of the Serial Tunneling profile is as follows:

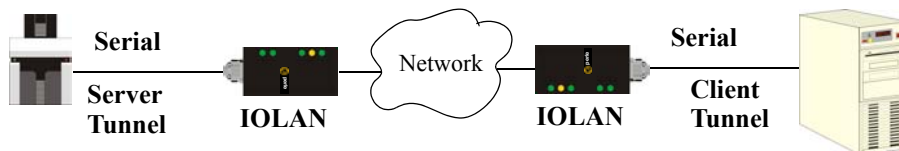

The **Server Tunnel** will also support Telnet Com Port Control protocol as detailed in RFC 2217.

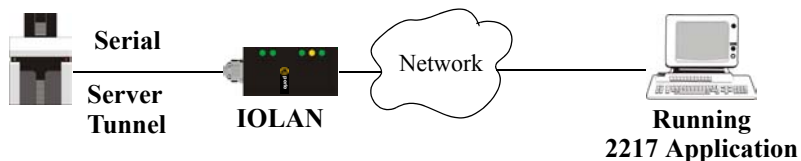

The IOLAN serial port signals will also follow the signals on the other serial port. If one serial port receives DSR then it will raise DTR on the other serial port. If one serial port receives CTS then it will raise RTS on the other serial port. The CD signal is ignored.

General Tab Field Descriptions

Configure the following parameters:

Act As Tunnel Server	The IOLAN will listen for an incoming connection request on the specified Internet Address on the specified TCP Port . Default: Enabled
TCP Port	The TCP port that the IOLAN will listen for incoming connection on. Default: 10000+serial port number; so serial port 2 is 10002.
Enable TCP Keepalive	Enables a per-connection TCP keepalive feature. After the configured number of seconds, the connection will send a gratuitous ACK to the network peer, thus either ensuring the connection stays active OR causing a dropped connection condition to be recognized. This parameter needs to be used in conjunction with Monitor Connection Status Interval parameter found in the Serial, Advanced, Advanced Settings tab. The interval determines how long the IOLAN will wait during inactivity before "testing" the connection. It should be noted that if a network connection is accidentally dropped, it can take as long as the specified interval before anyone can reconnect to the serial port. Default: Disabled
Act as Tunnel Client	The IOLAN will initiate the connection the Tunnel Server. Default: Disabled
Host Name	A preconfigured host name that is associated with the IP address of the Tunnel Server.
TCP Port	The TCP port that the IOLAN will use to connect to the Tunnel Server. Default: 10000+serial port number; so serial port 5 is 10005.

Advanced Tab Field Descriptions

The screenshot shows a configuration window with several tabs: General, Advanced (selected), Hardware, Email Alert, Packet Forwarding, and SSL/TLS. The 'Advanced Serial Tunneling Settings' section contains the following fields:

- Break Length: milliseconds
- Delay After Break: milliseconds
- Session Strings:
 - Send at Start:
 - Send at End:
- Delay after Send: milliseconds

Configure the following parameters:

- Break Length** When the IOLAN receives a command from its peer to issue a break signal, this parameter defines the length of time the break condition will be asserted on the serial port
Default: 1000ms (1 second)
- Delay After Break** This parameter defines the delay between the termination of a break condition and the time data will be sent out the serial port.
Default: 0ms (no delay).
- Session Strings** Controls the sending of ASCII strings to serial devices at session start and session termination as follows;
- **Send at Start**—If configured, this string will be sent to the serial device on power-up of the IOLAN or when a kill line command is issued on this serial port. If the "monitor DSR" or "monitor DCD" options are set, the string will also be sent when the monitored signal is raised.
Range: 0-127 alpha-numeric characters
Range: 0-FF hexadecimal
 - **Send at End**—If configured, this string will be sent to the serial device when the TCP session on the LAN is terminated. If multihost is configured, this string will only be sent to the serial device when the profile is configured as a listen mode connection and after all multihost connections are terminated.
Range: 0-127 alpha-numeric characters
Range: 0-FF hexadecimal
 - **Delay after Send**—If configured, will insert a delay after the string is sent to the device. This delay can be used to provide the serial device with time to process the string before the session is initiated or terminated.
Default: 10 ms

Virtual Modem Profile

Overview

Virtual Modem (Vmodem) is a feature of the IOLAN that provides a modem interface to a serial device. It will respond to AT commands and provide signals in the same way that a serially attached modem would. This feature is typically used when you are replacing dial-up modems with the IOLAN in order to provide Ethernet network connectivity.

Functionality

The serial port will behave in exactly the same fashion as it would if it were connected to a modem. Using AT commands, it can configure the modem and the issue a dial-out request (ATDT). The IOLAN will then translate the dial request into a TCP connection and data will begin to flow in both directions. The connection can be terminated by 'hanging' up the phone line.

You can also manually start a connection by typing **ATD<ip_address>,<port_number>** and end the connection by typing **+++ATH**. The **ip_address** can be in IPv4 or IPv6 formats and is the IP address of the receiver. For example, **ATD123.34.23.43,10001** or you can use **ATD12303402304310001**, without any punctuation (although you do need to add zeros where there are not three digits present, so that the IP address is 12 digits long).

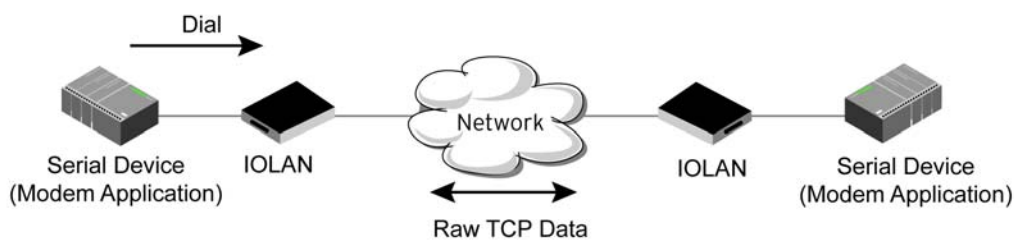

General Tab Field Descriptions

The screenshot shows the 'General' tab of the 'Virtual Modem Settings' dialog. It is divided into two main sections: 'Session Connection' and 'Connection Status'. In the 'Session Connection' section, 'Listen on TCP Port' is 10001, 'Connect Automatically At Startup' is selected, 'Host Name' is 'None', and 'TCP Port' is 0. In the 'Connection Status' section, 'Send Connection Status as:' is checked, 'Verbose String' is selected, 'Success String' is 'CONNECT', and 'Failure String' is 'NO CARRIER'. There is also a 'Numerical Code' option which is not selected.

Configure the following parameters:

- Listen on TCP Port** The IOLAN TCP port that the IOLAN will listen on.
Default: 10000 + serial port number (for example, serial port 12 defaults to 10012)
- Connect Automatically At Startup** When enabled, automatically establishes the virtual modem connection when the serial port becomes active.
Default: Enabled
- Host Name** The preconfigured target host name.
- TCP Port** The port number the target host is listening on for messages.
Default: 0 (zero)
- Connect Manually Via AT Command** When enabled, the virtual modem requires an AT command before it establishes a connection. Specify this option when your modem application sends a phone number or other AT command to a modem. The serial device can supply an IP address directly or it can provide a phone number that will be translated into an IP address by the IOLAN using the mapping table.
Default: Disabled
- Phone Number to Host Mapping Button** When your modem application provides a phone number in an AT command string, you can map that phone number to the destination host.
 See [Phone Number to Host Mapping](#) for information about the window that appears when you click this button.
- Send Connection Status As** When enabled, the connection success/failure indication strings are sent to the connected device, otherwise these indications are suppressed. This option also determines the format of the connection status results that are generated by the virtual modem.
Default: Enabled
- Verbose String** When enabled, the connection status is sent by text strings to the connected device.
Default: Disabled

- Success String** String that is sent to the serial device when a connection succeeds.
Default: CONNECT <speed>, for example, **CONNECT 9600**
- Failure String** String that is sent to the serial device when a connection fails.
Default: NO CARRIER
- Numeric Codes** When enabled, the connection status is sent to the connected device using the following numeric codes:
- 1 Successfully Connected
 - 2 Failed to Connect
 - 4 Error
- Default:** Enabled

Advanced Tab Field Descriptions

The screenshot shows the 'Advanced Virtual Modem Settings' dialog box. It is divided into two main sections: 'Modem Setup' and 'Virtual Modem Features'.
 In the 'Modem Setup' section:
 - 'Echo characters in command mode' is checked.
 - Under 'Hardware Signal Assignment', there are two columns: 'DTR Signal' and 'RTS Signal'. Each has three radio button options: 'Always On' (selected), 'Acts as DCD', and 'Acts as RI'.
 - Under 'DCD Signal', there are two radio button options: 'Always On' (selected) and 'On when host connection established'.
 - There is a text field for 'Additional modem initialization:'.
 In the 'Virtual Modem Features' section:
 - 'Enable Message of the Day (MOTD)' and 'Enable TCP Keepalive' are unchecked.
 - 'AT Command Response Delay' is set to 250 milliseconds.
 - 'Session Strings' section has a text field for 'Send at Start:' and a 'Delay after Send:' of 10 milliseconds.

Configure the following parameters:

- Echo characters in command mode** When enabled, echoes back characters that are typed in (equivalent to ATE0/ATE1 commands).
Default: Disabled
- DTR Signal Always On** Specify this option to make the DTR signal always act as a DTR signal.
Default: Enabled
- DTR Signal Acts as DCD** Specify this option to make the DTR signal always act as a DCD signal.
Default: Disabled
- DTR Signal Acts as RI** Specify this option to make the DTR signal always act as a RI signal.
Default: Disabled
- RTS Signal Always On** Specify this option to make the RTS signal always act as a RTS signal.
Default: Enabled

RTS Signal Acts as DCD	Specify this option to make the RTS signal always act as a DCD signal. Default: Disabled
RTS Signal Acts as RI	Specify this option to make the RTS signal always act as a RI signal. Default: Disabled
DCD Signal Always On	When you configure the DTR or RTS signal pin to act as a DCD signal, enable this option to make the DCD signal always stay on. Default: Enabled
DCD Signal On when host connection established	When you configure the DTR or RTS signal pin to act as a DCD signal, enable this option to make the DCD signal active only during active communication. Default: Disabled
Additional modem initialization	You can specify additional virtual modem commands that will affect how virtual modem starts. The following commands are supported: ATQn, ATVn, ATEn, +++ATH, ATA, ATIO, ATI3, ATSO, AT&Z1, AT&Sn, AT&Rn, AT&Cn, AT&F, ATS2, ATS12, ATO (ATD with no phone number), and ATDS1. See Virtual Modem AT Commands for a more detailed explanation of the support initialization commands.
Enable Message of the Day (MOTD)	When enabled, displays the Message of the Day (MOTD) when a successful virtual modem connection is made. Default: Disabled
Enable TCP Keepalive	Enables a per-connection TCP keepalive feature. After the configured number of seconds, the connection will send a gratuitous ACK to the network peer, thus either ensuring the connection stays active OR causing a dropped connection condition to be recognized. This parameter needs to be used in conjunction with Monitor Connection Status Interval parameter found in the Serial, Advanced, Advanced Settings tab. The interval determines how long the IOLAN will wait during inactivity before "testing" the connection. It should be noted that if a network connection is accidentally dropped, it can take as long as the specified interval before anyone can reconnect to the serial port. Default: Disabled
AT Command Response Delay	The amount of time, in milliseconds, before an AT response is sent to the requesting device. Default: 250 ms
Session Strings	Controls the sending of ASCII strings to serial devices at session start as follows; <ul style="list-style-type: none"> ● Send at Start—If configured, this string will be sent to the serial device on power-up of the IOLAN or when a kill line command is issued on the serial port. If the "monitor DSR" or "monitor DCD" options are set, the string will also be sent when the monitored signal is raised. Range: 0-127 alpha-numeric characters Range: Hexadecimal 0-FF ● Delay after Send—If configured, will inset a delay after the string is sent to the device. This delay can be used to provide the serial device with time to process the string before the session is initiated or terminated. Default: 10 ms

Phone Number to Host Mapping

If your modem application dials using a phone number, you can add an entry in the Phone Number to Host Mapping window that can be accessed by all serial ports configured as Virtual Modem. You need to enter the phone number sent by your modem application and the IOLAN IP address and TCP Port that will be receiving the 'call.' The DS1 supports up to 4 entries and the TS2 supports up to 8 entries.

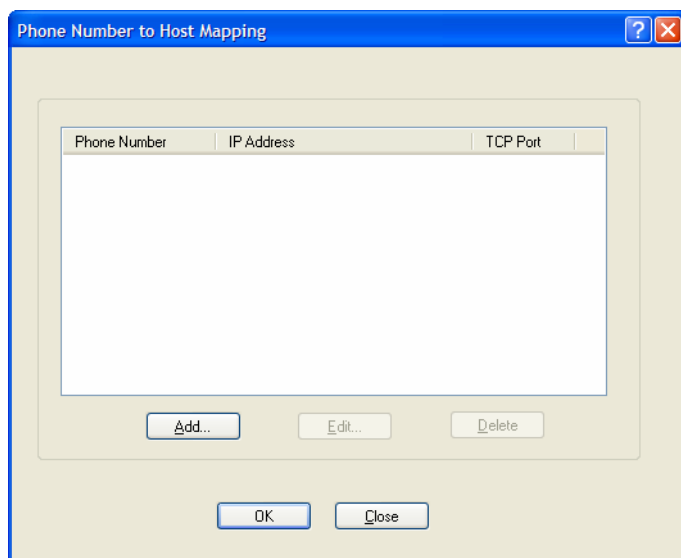

The following buttons are available:

- Add Button** Click the **Add** button to display a window that allows you to configure the phone number or AT command your modem application sends and the IOLAN's IP address and TCP port number that is receiving the call.
- Edit Button** Click on a phone number entry and click the **Edit** button to change any values configured for the phone number.
- Delete Button** Click on a phone number entry and click the **Delete** button to remove it from the phone number list.

VModem Phone Number Entry

Create an entry in the Phone Number to Host Mapping window.

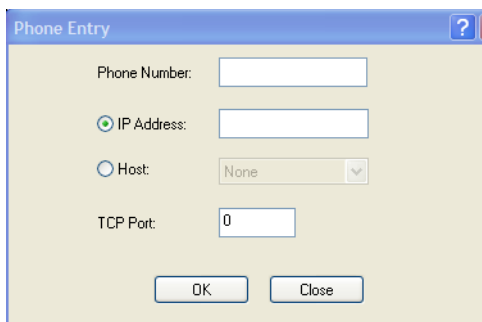

Configure the following parameters:

Phone Number	Specify the phone number your modem application sends to the modem. Note: The IOLAN does not validate the phone number, so it must be entered in the exact way the application will send it. For example, if you enter 555-1212 in this table and the application sends 5551212, the IOLAN will not match the two numbers. Spaces will be ignored.
Host IP Address	Select the host name (from the host table) of the IOLAN that is receiving the virtual modem connection.
Host Name	Select the host name (from the host table) of the IOLAN that is receiving the virtual modem connection.
Host IP Address	Specify the IP address of the IOLAN that is receiving the virtual modem connection.

Control Signal I/O Profile

Overview

The **Control Signal I/O** profile is only available on IOLAN I/O models. When you configure a serial port for **Control Signal I/O**, you are using the DSR, DCD, CTS, DTR, and RTS serial pins for I/O channel Digital Input (DSR, DCD, and CTS) or Digital Output (DTR and RTS).

Functionality

The Control Signal I/O profile enables the use of the EIA-232 serial port pins to be used as assigned Digital Inputs or Digital Outputs.

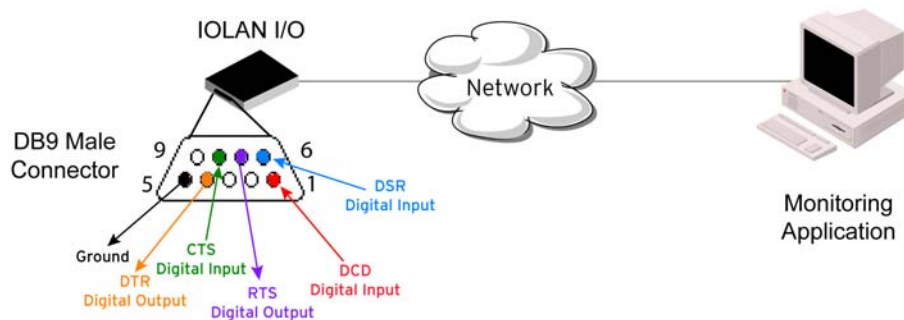

General Tab Field Descriptions

The **General** tab displays the signal pins. This window is also used to enable/disable the signal pins.

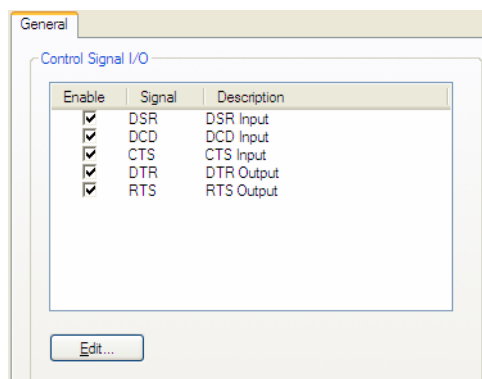

Highlight a signal and then click the **Edit** button to configure the signal pin's parameters.

Input Signal Field Descriptions

See [Digital I/O Extension](#) for information about the **I/O Extension** tab.

Configure the following parameters:

- | | |
|------------------------|--|
| Description | Provide a description of the channel, making it easier to identify.
Data Options: Maximum 20 characters, including spaces |
| Latch | Latches (remembers) the activity transition (active to inactive or inactive to active).
Data Options: None, Inactive-to-Active, Active-to-Inactive
Default: None |
| Invert Signal | When enabled, inverts the actual condition of the I/O signal in the status; therefore, an inactive status will be displayed as active.
Default: Disabled |
| Trigger | When the trigger condition is met, triggers the specified alarm action.
Data Options: <ul style="list-style-type: none"> ● Disabled—No alarm settings. This is the default. ● Inactive—When the expected Digital input is active, going inactive will trigger an alarm. ● Active—When the expected Digital input is inactive, going active will trigger an alarm. Default: Disabled |
| Auto Clear Mode | When enabled, automatically clears the alarm when the trigger condition changes; for example, if the Trigger is Inactive and the alarm is triggered, once the input becomes active again, the alarm will automatically be cleared
Default: Enabled |

Manual Clear Mode	When enabled, a triggered alarm must be manually cleared. Default: Disabled
Syslog	When enabled, sends a message to syslog when an alarm is triggered or cleared. The syslog entry includes the severity level and the value that caused the alarm to trigger or clear. The syslog message is associated with Level Critical . Default: Disabled
SNMP	When enabled, sends an SNMP trap when an alarm is triggered or cleared. The trap consists of the severity level and whether the alarm was triggered or cleared. Default: Disabled

Output Signal Field Descriptions

See [Digital I/O Extension](#) for information about the **I/O Extension** tab.

The screenshot shows a configuration window with two tabs: 'General' and 'I/O Extension'. The 'I/O Extension' tab is active. Under the heading 'Digital Output - DTR', there is a 'Description:' label followed by an empty text input field. Below this is a section titled 'Digital Output Settings' which contains a 'Failsafe Action:' label and a dropdown menu currently set to 'None'.

Configure the following parameters:

Description	Provide a description of the channel, making it easier to identify. Data Options: Maximum 20 characters, including spaces
Failsafe Action	When there has been no I/O activity within the specified time (set in the I/O Interfaces, Settings on the Failsafe Timer tab) and the Failsafe Timer is triggered. Data Options: <ul style="list-style-type: none"> ● None—The state of the Digital/Relay output remains the same, no change. ● Activate Output—Activates the channel. ● Deactivate Output—Deactivates the channel. Default: None

Modbus Gateway Profile

Overview

Each serial port can be configured as either a Modbus Master gateway or a Modbus Slave gateway, depending on your configuration and requirements. If your model supports I/O, see [Modbus I/O Access](#) for more information on using the Modbus protocol to access I/O data.

Functionality

The Modbus Gateway profile configures a serial port to act as a Modbus Master Gateway or a Modbus Slave Gateway.

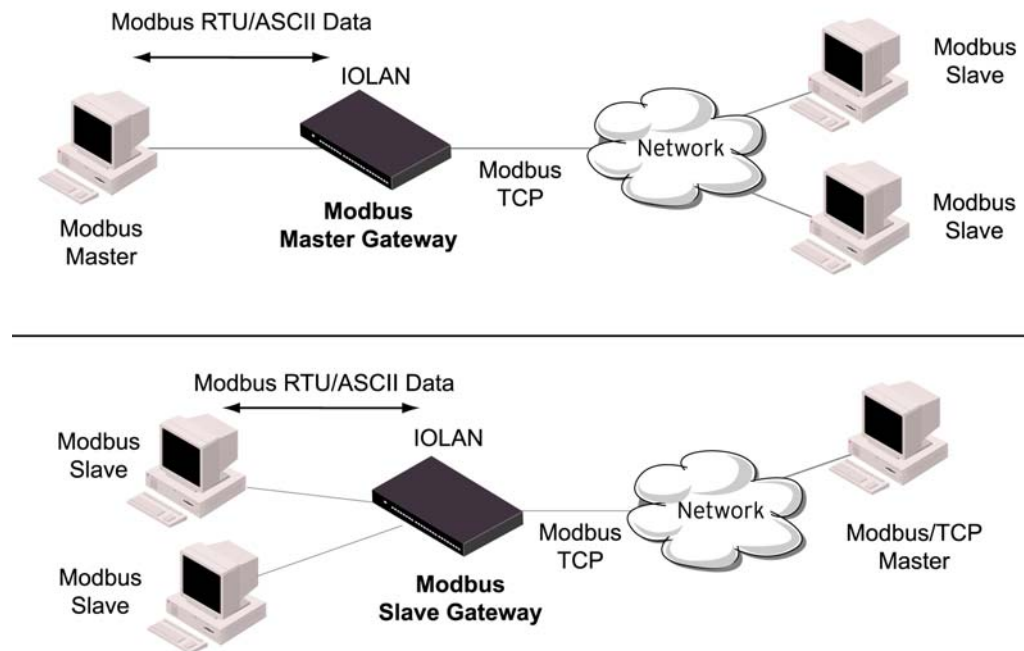

General Tab Field Descriptions

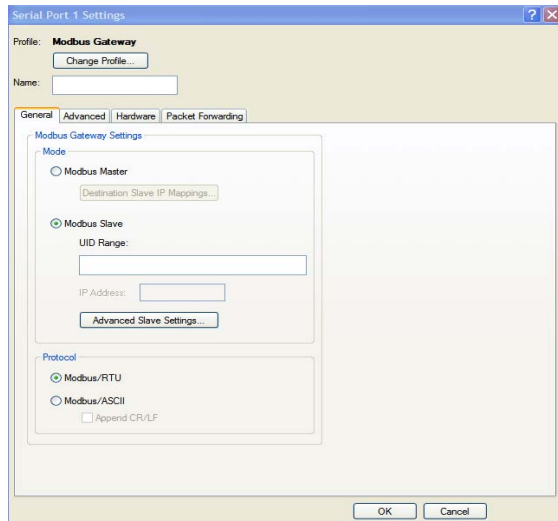

Configure the following parameters:

- Mode** Specify how the Modbus Gateway is defined on the serial port.
Data Options:
- **Modbus Master**—Typically, the Modbus Master is connected to the Serial Port and is communicating to Modbus Slaves on the network.
 - **Modbus Slave**—Typically, the Modbus Master is accessing the IOLAN through the network to communicated to Modbus Slaves connected to the IOLAN's Serial Ports.
- Default:** Modbus Master Gateway
- Destination Slave IP Mappings Button** Click this button to launch the Destination Slave IP Settings window, where you can configure the TCP/Ethernet Modbus Slaves that the Modbus Master on the Serial Port will communicate with.
- UID Range** You can specify a range of UIDs (1-247), in addition to individual UIDs.
Field Format: Comma delimited; for example, 2-35, 50, 100-103
- IP address** Set the IP Address to be used for this serial port when using the IP Aliasing feature.
See [Enable IP Aliasing](#) for details about how to enable this feature.
- Advanced Slave Settings Button** Click this button to configure global Modbus Slave settings.
- Modbus/RTU** Select this option when the Modbus/RTU protocol is being used for communication between the Modbus Master and Slave.
Default: Enabled
- Modbus/ASCII** Select this option when Modbus/ASCII protocol is being used for communication between the Modbus Master and Slave.
Default: Disabled
- Append CR/LF** When **Modbus/ASCII** is selected, adds a CR/LF to the end of the transmission; most Modbus devices require this option.
Default: Enabled

Advanced Field Descriptions

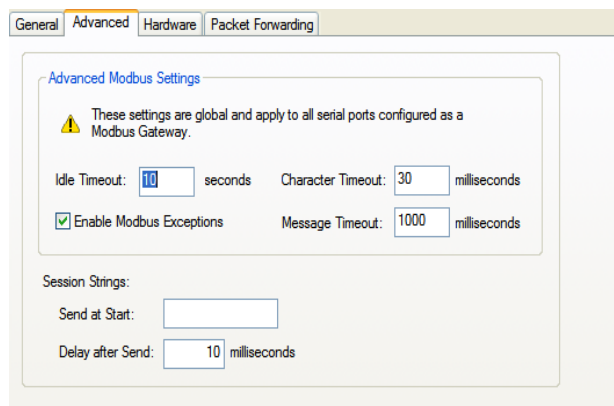

General **Advanced** Hardware Packet Forwarding

Advanced Modbus Settings

⚠ These settings are global and apply to all serial ports configured as a Modbus Gateway.

Idle Timeout: seconds Character Timeout: milliseconds

Enable Modbus Exceptions Message Timeout: milliseconds

Session Strings:

Send at Start:

Delay after Send: milliseconds

Configure the following parameters:

- Idle Timeout** Use this timer to close a connection because of inactivity. When the **Idle Timeout** expires, the IOLAN will end the connection.
Range: 0-4294967 seconds (about 49 days)
Default: 0 (zero), which does not timeout, so the connection is permanently open.
- Enable Modbus Exceptions** When enabled, an exception message is generated and sent to the initiating Modbus device when any of the following conditions are encountered: there is an invalid UID, the UID is not configured in the Gateway, there is no free network connection, there is an invalid message, or the target device is not answering the connection attempt.
Default: Enabled
- Character Timeout** Used in conjunction with the Modbus RTU protocol, specifies how long to wait, in milliseconds, after a character to determine the end of frame.
Range: 10-10000
Default: 30 ms
- Message Timeout** Time to wait, in milliseconds, for a response message from a Modbus TCP or serial slave (depending if the Modbus Gateway is a Master Gateway or Slave Gateway, respectively) before sending a Modbus exception.
Range: 10-10000
Default: 1000 ms
- Session Strings** Controls the sending of ASCII strings to serial devices at session start as follows;
- **Send at Start**—If configured, this string will be sent to the serial device on power-up of the IOLAN or when a kill line command is issued on the serial port. If the "monitor DSR" or "monitor DCD" options are set, the string will also be sent when the monitored signal is raised.
Range: 0-127 alpha-numeric characters
Range: Hexadecimal 0-FF
 - **Delay after Send**—If configured, will inset a delay after the string is sent to the device. This delay can be used to provide the serial device with time to process the string before the session is initiated or terminated.
Default: 10 ms

Modbus Slave IP Settings Field Descriptions

This window is used to configure the Modbus Slaves.

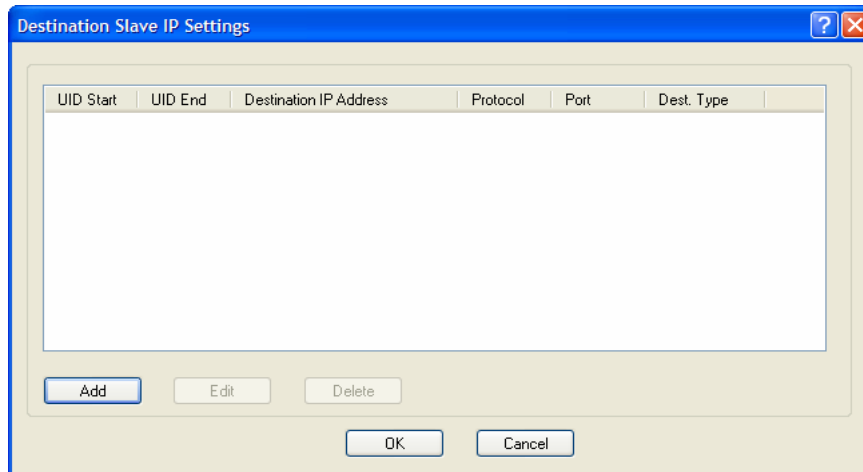

The following buttons are available:

- Add Button** Adds an entry into the Modbus Destination Slave IP Settings table.
- Edit Button** Edits an entry in the Modbus Destination Slave IP Settings table.
- Delete Button** Deletes an entry from the Modbus Destination Slave IP Settings table.

Adding/Editing Modbus Slave IP Settings

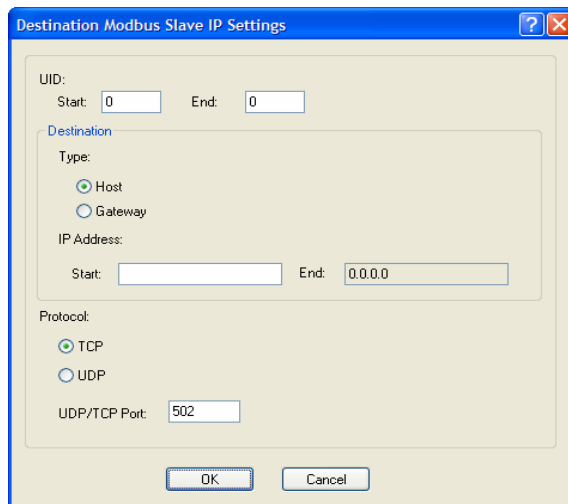

Configure the following parameters:

- UID Start** When **Destination** is set to **Host** and you have sequential Modbus Slave IP addresses (for example, 10.10.10.1, 10.10.10.2, 10.10.10.3, etc.), you can specify a UID range and the IOLAN will automatically increment the last digit of the configured IP address. Therefore, you can specify a UID range of 1-100, and the IOLAN will route Master Modbus messages to all Modbus Slaves with IP addresses of 10.10.10.1 - 10.10.10.100.
Range: 1-247
Default: 0 (zero)

UID End	<p>When Destination is set to Host and you have sequential Modbus Slave IP addresses (for example, 10.10.10.1, 10.10.10.2, 10.10.10.3, etc.), you can specify a UID range and the IOLAN will automatically increment the last digit of the configured IP address. Therefore, you can specify a UID range of 1-100, and the IOLAN will route Master Modbus messages to all Modbus Slaves with IP addresses of 10.10.10.1 - 10.10.10.100.</p> <p>Range: 1-247 Default: 0 (zero)</p>
Type	<p>Specify the configuration of the Modbus Slaves on the network.</p> <p>Data Options:</p> <ul style="list-style-type: none">● Host—The IP address is used for the first UID specified in the range. The last octet in the IPv4 address is then incremented for subsequent UID's in that range. The Host option is not applicable for IPv6 addresses.● Gateway—The Modbus Master Gateway will use the same IP address when connecting to all the remote Modbus slaves in the specified UID range. <p>Default: Host</p>
Start IP Address	<p>The IP address of the TCP/Ethernet Modbus Slave.</p> <p>Field Format: IPv4 or IPv6 (IPv6 format not supported for Destination Host)</p>
End IP Address	<p>Displays the ending IP address of the TCP/Ethernet Modbus Slaves, based on the Start IP address and the UID range.</p>
Protocol	<p>Specify the protocol that is used between the Modbus Master and Modbus Slave(s).</p> <p>Data Options: TCP or UDP Default: TCP</p>
UDP/TCP Port	<p>The destination port of the remote Modbus TCP Slave that the IOLAN will connect to.</p> <p>Range: 0-65535 Default: 502</p>

Modbus Slave Advanced Settings Field Descriptions

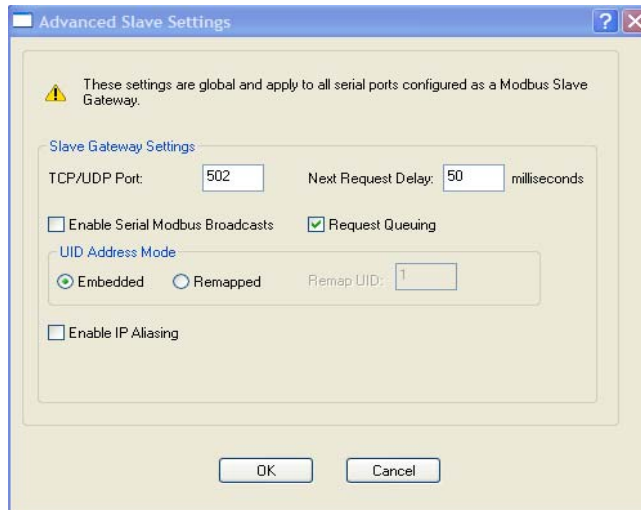

Configure the following parameters:

- TCP/UDP Port** The network port number that the Slave Gateway will listen on for both TCP and UDP messages.
Default: 502
- Next Request Delay** A delay, in milliseconds, to allow serial slave(s) to re-enable receivers before issuing next Modbus Master request.
Range: 0-1000
Default: 50 ms
- Enable Serial Modbus Broadcasts** When enabled, a UID of 0 (zero) indicates that the message will be broadcast to all Modbus Slaves.
Default: Disabled
- Request Queuing** When enabled, allows multiple, simultaneous messages to be queued and processed in order of reception.
Default: Enabled
- Embedded** When this option is selected, the address of the slave Modbus device is embedded in the message header.
Default: Enabled
- Remapped** Used for single device/port operation. Older Modbus devices may not include a UID in their transmission header. When this option is selected, you can specify the UID that will be inserted into the message header for the Modbus slave device. This feature supersedes the Broadcast feature.
Default: Disabled
- Remap UID** Specify the UID that will be inserted into the message header for the Slave Modbus serial device.
Range: 1-247
Default: 1

Enable IP Aliasing When enabled, allows for multiple requests to serial slaves (from an Ethernet Master/s) to be processed simultaneously.

Default: Off

See [IP address](#) for details about setting the IP address to be used with this serial port.

Custom Application Profile

Overview

The **Custom App/Plugin** profile is used in conjunction with custom applications created for the IOLAN by using the Perle SDK. See the *SDK Programmer's Guide* (the SDK and guide are accessible via a request form located on the Perle website at www.perle.com/supportfiles/SDK_Request.shtml) for information about the functions that are supported. You must download the program and any auxiliary files to the IOLAN and set the serial port to the **Custom App/Plugin** profile to actually run a custom application. You must also specify the program executable and any parameters you want to pass to the program in the **Command Line** field.

General Tab Field Description

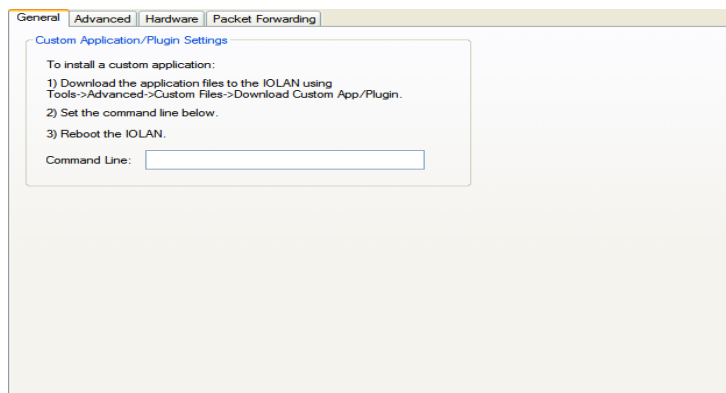

Configure the following parameter:

Command Line The name of the SDK program executable that has been already been downloaded to the IOLAN, plus any parameters you want to pass to the program. Use the **shell** CLI command as described in the *SDK Programmer's Guide* to manage the files that you have downloaded to the IOLAN. For example, using sample outraw program, you would type:

```
outraw 192.168.2.1:10001 Acct:10001
```

if you were starting the application on a serial port.

Field Format: Maximum of 80 characters

Advanced

Advanced Serial Settings Tab

Overview

Advanced serial port settings apply to all serial ports.

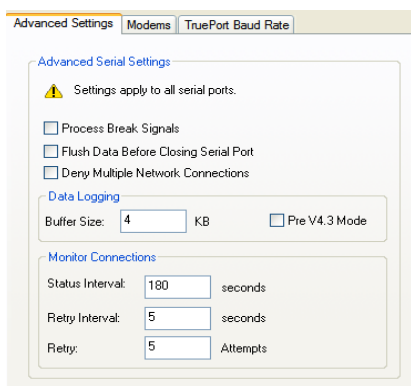

Field Descriptions

Configure the following parameters:

Process Break Signals	Enables/disables the Telnet break signal and the out-of-band break signals for TruePort. Default: Disabled
Flush Data Before Closing Serial Port	When enabled, deletes any pending data when a port is closed. Default: Disabled
Deny Multiple Network Connections	Allows only one network connection at a time per a serial port. Application accessing a serial port device across a network will get a connection (socket) refused until: <ul style="list-style-type: none"> • All data from previous connections on that serial port has drained • There are no other connections • Up to a 1 second interconnection poll timer has expired Enabling this feature automatically enables a TCP keepalive mechanism which is used to detect when a session has abnormally terminated. The keepalive is sent after 3 minutes of network connection idle time. Applications using this feature need to be aware that there can be some considerable delay between a network disconnection and the port being available for the next connection attempt, allowing any data sent on prior connections to be transmitted out of the serial port. Application network retry logic needs to accommodate this feature. Default: Disabled

Data Logging Buffer Size	<p>The minimum data buffer size for all models is 1 KB. The maximum data buffer is 2000 KB for the DS1/TS2/STS8D, all other models are 4000 KB. If the data buffer is filled, incoming serial data will overwrite the oldest data.</p> <p>Note: A kill line or a reboot of the IOLAN causes all buffered data to be lost</p> <p>Values: 1-2000 KB (DS1/TS2/STS8D) - default is 4 KB</p> <p>Values: 1-4000 KB (all other models) - default is 256 KB</p> <p>The Data logging feature is a valid option for the <i>TruePort Profile</i> and <i>TCP Sockets Profile</i>.</p>
Pre V4.3G Data Logging Mode	<p>Enable the data logging feature previous to V4.3G firmware.</p> <p>Default: Disabled</p>
Monitor Connection Interval Status	<p>Specify how often, in seconds, the IOLAN will send a TCP Keepalive to services that support TCP Keepalive.</p> <p>Default: 180 seconds</p>
Retry Interval	<p>Sets the maximum time to wait for a response after sending a TCP keepalive message.</p> <p>Values: 1-32767 seconds</p> <p>Default: 5 seconds</p>
Retry Attempts	<p>The number of TCP keepalive retries before the connection is closed.</p> <p>Values: 1-32767</p> <p>Default: 5</p>

Modems Tab

Overview

You need to configure a modem if there is a modem connected to the IOLAN.

When you click on the **Modems** tab, you will see the following:

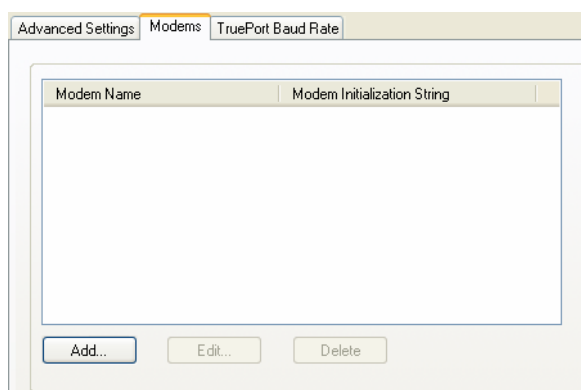

If any modems have been configured, they will be displayed.

Adding/Editing a Modem

You can add new modems or edit existing modems through the following window:

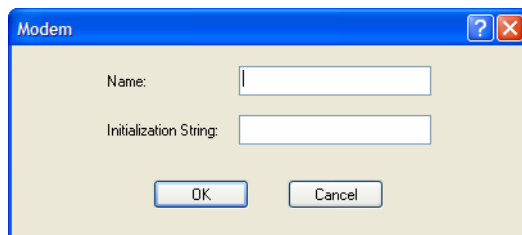

Configure the following parameters:

Name The name of the modem.
Restrictions: Do not use spaces.

Initialization String The initialization string of the modem; see your modem's documentation.

TruePort Baud Rate Tab

Overview

The TruePort utility acts as a COM port redirector that allows applications to talk to serial devices across a network as though the serial devices were directly attached to the server. For IOLAN I/O models, you can also monitor and control I/O through the TruePort client.

Functionality

Since some older applications may not support the higher baud rates that the IOLAN is capable of achieving, the baud rate can be mapped to a different value on the IOLAN. Through TruePort, you can map the baud rate of the host COM port to a higher baud rate for the serial line that connects the serial device and the IOLAN. See [TruePort](#) for more information about the TruePort utility.

Field Definitions

TruePort	Actual Baud Rate
50	57600
75	75
110	115200
134	230400
150	150
200	200
300	300
600	600
1200	1200
1800	1800
2400	2400
4800	4800
9600	9600
19200	19200
38400	38400

Configure the following parameter:

Actual Baud Rate The actual baud rate that runs between the IOLAN and the connected serial device.

Range: 50-230400, you can also specify a custom baud rate



Network Settings

Introduction

The Network section is used to configure the parameters that identify the IOLAN within the network and how the IOLAN accesses hosts on the network. The following configuration windows are available:

- **IP Settings**—This window sets up IOLAN’s name, IPv4 address, IPv6 address, and Ethernet information. See [IP Settings](#) for more information.
- **Advanced**—This window configures hosts that the IOLAN will be communicating with and routes. See [Advanced](#) for more information on these options.

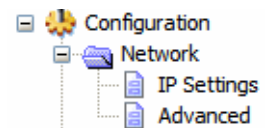

IP Settings

IPv4 Settings

Overview

The parameters in IPv4 settings are used to access the IOLAN and are how the IOLAN accesses the network.

Field Descriptions

Configure the following parameters:

- System Name** The **System Name** is used for informational purposes by such tools as the DeviceManager and is also used in conjunction with the Domain field to construct a fully qualified domain name (FQDN).
Default: IOLAN-xxxxxx (where xxxxxx is the last 6 digits of the IOLAN's MAC address)
- Domain** This field is combined with the **System Name** to construct the fully qualified domain name (FQDN). For example, if the domain is **mycompany.com** and the **Server Name** is set to **accounting**, the FQDN would be **accounting.mycompany.com**.
- Obtain IP Address automatically using DHCP/BOOTP** When enabled, the IOLAN will request an IP address from the DHCP/BOOTP server. By default, when this option is enabled, the IOLAN will also attempt to retrieve the DNS server, WINS server, and default gateway from the DHCP/BOOTP server.
Default: Disabled
- Use the following IP Address** Assign a specific IP address to the IOLAN.
- IP Address** The IOLAN's unique IPv4 network IP address. If you are using the IOLAN in an IPv6 network, this field can be left blank.
Field Options: IPv4 address

Subnet Mask	The network subnet mask. For example, 255.255.0.0.
Default Gateway	Specify the gateway IP address that will provide general access beyond the local network. Field Options: IPv4 address
Default Gateway Obtain Automatically	When DHCP/BOOTP is enabled, you can enable this option to have the IOLAN receive the Default Gateway IP address from the DHCP/BOOTP server. Default: Enabled

IPv6 Settings

Overview

The parameters in IPv6 settings are used to access the IOLAN and are how the IOLAN accesses the network.

Field Descriptions

Configure the following parameters:

Obtain IPv6 Address(es) using	When enabled, you can configure the IOLAN to obtain the IPv6 address(es) using IPv6 Autoconfiguration or a DHCPv6 server. Default: Enabled
IPv6 Autoconfiguration	When enabled, the IOLAN will send out a Router Solicitation message. If a Router Advertisement message is received, the IOLAN will configure the IPv6 address(es) and configuration parameters based on the information contained in the advertisement. If no Router Advertisement message is received, the IOLAN will attempt to connect to a DHCPv6 server to obtain IPv6 addresses and other configuration parameters. Default: Enabled
DHCPv6	When enabled, requests IPv6 address(es) and configuration information from the DHCPv6 server. Default: Disabled

Custom IPv6 List	Displays the list of custom configured IPv6 addresses.
Add Button	Adds a custom IPv6 address.
Edit Button	Edits an existing IPv6 address.
Delete Button	Deletes an IPv6 address from the Custom IPv6 address list.
Default Gateway	Specify the gateway IP address that will provide general access beyond the local network. Field Format: IPv6 address
DHCPv6 Settings IPv6 Address(es)	When enabled, the IOLAN will accept IPv6 address(es) from the DHCPv6 server. Default: Disabled
DHCPv6 Settings Network Prefix	When enabled, the IOLAN will accept the network prefix from the DHCPv6 server. Default: Disabled

Adding/Editing a Custom IPv6 Address

You can manually add one of the following:

- The IPv6 network prefix (and the IOLAN will determine an IPv6 address based on the network prefix and the IOLAN MAC address).
- The complete IPv6 address.

Field Descriptions

Configure the following parameters:

Create a unique IPv6 address on the network	When enabled, the IOLAN will derive an IPv6 address from the entered network prefix and the IOLAN's MAC address. Default: Enabled
Network Prefix	Specify the IPv6 network prefix. The IOLAN will derive the complete IPv6 address from the entered network prefix and the IOLAN's MAC address. Default: Enabled
Network Prefix IPv6 Prefix Bits	Specify the network prefix bits for the IPv6 address. Range: 0-64 Default: 64

Use the following IPv6 address	Enable this option when you want to enter a specific IPv6 address. Default: Disabled
IPv6 Address	Specify the complete IPv6 address. Field Format: IPv6 address
IPv6 Address IPv6 Prefix Bits	Specify the network prefix bits for the IPv6 address. Range: 0-128 Default: 64

Advanced

Overview

The **Advanced** tab configures the Ethernet interface hardware speed and duplex.

Field Descriptions

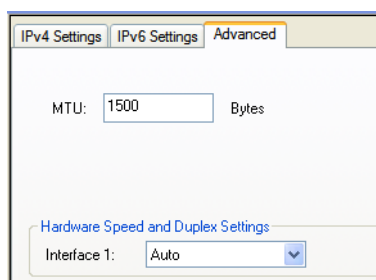

Configure the following parameter:

Interface1	Define the Ethernet connection speed. Data Options: <ul style="list-style-type: none"> ● Auto—automatically detects the Ethernet interface speed and duplex ● 10 Mbps Half Duplex ● 10 Mbps Full Duplex ● 100 Mbps Half Duplex ● 100 Mbps Full Duplex Default: Auto
Maximum Transmission Unit	The Maximum Transmission Unit (MTU) size of an IP frame that will be sent over the network. Only one MTU size can be set for both IPV4 or IPV6 frames. Default IPV4: 68-1500 bytes Default IPV6: 68-1500 bytes

Advanced

Host Table

Overview

The Host table contains the list of hosts that will be accessed by an IP address from the IOLAN. This table will contain a symbolic name for the host as well as its IP address. When a host entry is required elsewhere in the configuration, the symbolic name will be used.

Functionality

You can configure up to 50 hosts using IPv4 or IPv6 internet addresses on desktop IOLAN models.

Field Descriptions

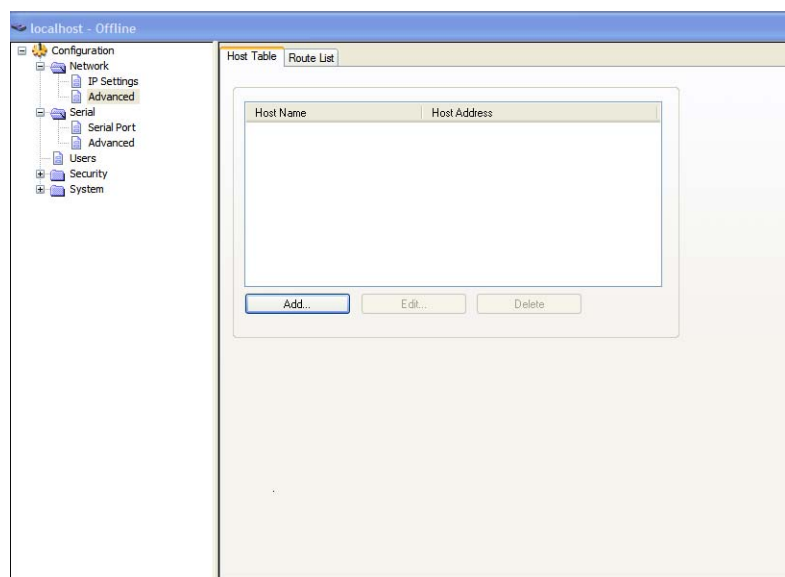

Configure the appropriate parameters:

- Add Button** Adds a host to the host table.
- Edit Button** Changes a host that already exists in the host table.
- Delete Button** Deletes a host from the host table.

Adding/Editing a Host

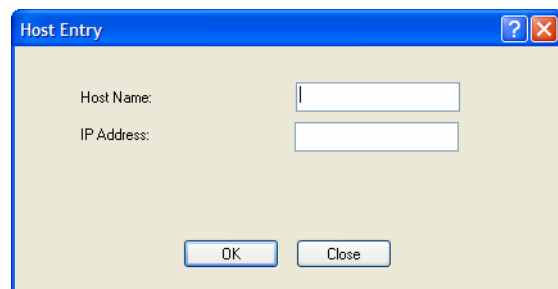

Configure the appropriate parameters:

Host Name	The name of the host. This is used only for the IOLAN configuration. Text Characteristics: Up to 14 characters, no spaces.
IP Address	The host's IP address. Text Characteristics: IPv4 or IPv6 Address

Route List

Overview

Entering routes in the routing list enables the identification of gateways to be used for accessing specific hosts or external networks from the IOLAN's local network.

Functionality

There are three types of routes:

- **Default**—A route that provides general access beyond your local network.
- **Host**—A route defined for accessing a specific host external to your local network.
- **Network**—A route defined for accessing a specific network external to your local network.

You can specify up to 20 routes on desktop IOLAN models.

Field Descriptions

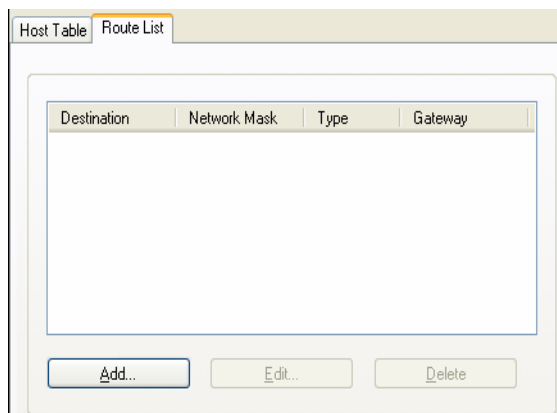

The following buttons are available:

Add Button	Adds a route to the Route List.
Edit Button	Changes an existing route in the Route List.
Delete Button	Deletes a route from the Route List.

Adding/Editing Routes

From the **Route List** tab, if you click the **Add** or **Edit** button, you will be able to add a new or edit an existing route.

The screenshot shows a 'Route' dialog box with the following configuration:

- Destination:**
 - Type: Host, Network, Default
 - IP Address: [Empty text box]
 - IPv4 Subnet Mask: 255 . 255 . 255 . 255
 - IPv6 Prefix Bits: 0
- Gateway:**
 - Host: None (dropdown menu)

Buttons: OK, Cancel

Configure the appropriate parameters:

- Type** Specify the type of route you want to configure.
- Data Options:**
- **Host**—A route defined for accessing a specific host external to your local network.
 - **Network**—A route defined for accessing a specific network external to your local network.
 - **Default**—A route which provides general access beyond your local network.
- Default:** Default
- IP Address** When the route **Type** is defined as **Host**, this field will contain the IP address of the host. If the route **Type** is defined as **Network**, the network portion of the IP address must be specified and the Host port of the address will be set to 0. Example: to access network 10.10.20, the address 10.10.20.0 would be specified in this field.
Format: IPv4 or IPv6 Address
- IPv4 Subnet Mask** When the route is a **Network** route, you must specify the network's subnet mask.
- IPv6 Prefix Bits** If the IP address is IPv6, then you must specify the network's prefix bits.
Range: 0-128
- Host** The host that is being used at the route gateway.



Configuring Users

Introduction

You can configure up to four users in the IOLAN's local user database, in addition to the admin user. A user can even represent a device, like a barcode reader or a card swipe device, that you want to be authenticated.

When users are connecting to the IOLAN via serial ports, the user database can be used to:

- Have the user authenticated prior to establishing a connection to a network host.
- Establish a different connection type to the host specific to each user.
- Create a profile different from the Default user profile.

When users are connecting to the IOLAN from a network connection, the user database can be used to:

- Authenticate users prior to providing access to a serially attached console port (such as a Unix server or router).

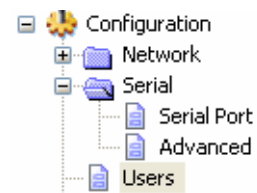

User Settings

Overview

The Users window allows you to add, edit, and delete users from the IOLAN.

Functionality

The Users window displays the users who have been configured. You can add users, edit existing users, or delete users from this window. See [Adding/Editing Users](#) for information on the parameters available when adding or editing a user.

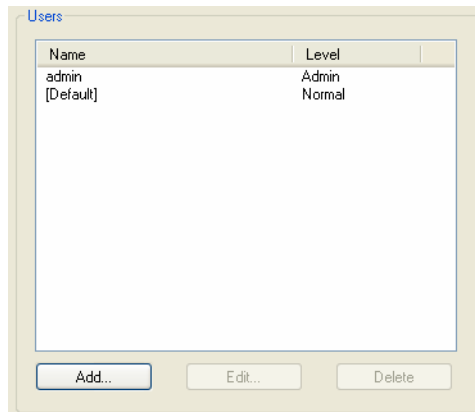

Adding/Editing Users

General Tab

Overview

The General tab configures the basic user information.

Functionality

You must, minimally, provide a **User Name** and **Level** for a user.

Field Descriptions

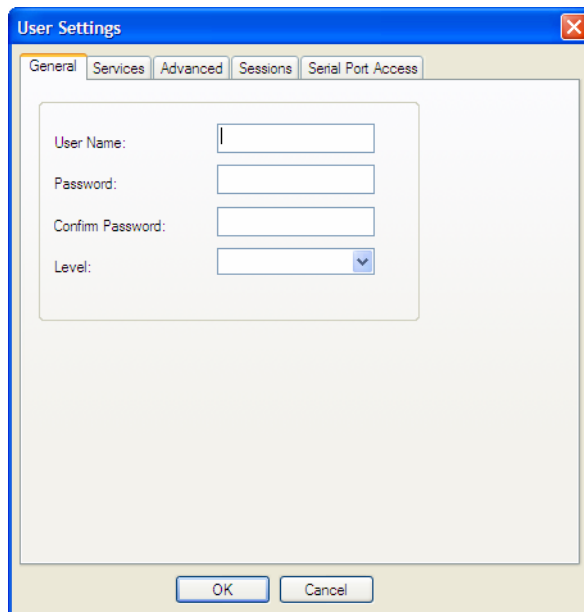
The image shows a screenshot of a 'User Settings' dialog box with a blue title bar and a close button. The dialog has five tabs: 'General', 'Services', 'Advanced', 'Sessions', and 'Serial Port Access'. The 'General' tab is selected. Inside the dialog, there is a light gray rectangular area containing four input fields: 'User Name' (a text box), 'Password' (a text box), 'Confirm Password' (a text box), and 'Level' (a dropdown menu). At the bottom of the dialog, there are two buttons: 'OK' and 'Cancel'.

Configure the following parameters:

User Name The name of the user.
Restrictions: Do not use spaces.

Password The password the user will need to enter to login to the IOLAN.

Confirm Password Enter the user's password again to verify it is entered correctly.

Level	<p>The access that a user is allowed.</p> <p>Data Options:</p> <ul style="list-style-type: none">● Admin—The admin level user has total access to the IOLAN. You can create more than one admin user account but we recommend that you only have one. They can monitor and configure the IOLAN. Users configured with this level can access the unit either via serial Terminal Profile connection or via a network originated Telnet connection to the IOLAN.● Normal—The Normal level user has limited access to the IOLAN. Limited CLI commands and Menu access are available with the ability to configure the user's own configuration settings. Users configured with this level can access the unit either via serial Terminal Profile connection or via a network originated Telnet connection to the IOLAN.● Restricted—The Restricted level user can only access predefined sessions or access the Easy Port Access menu. Users configured with this level will be restricted to pre-defined sessions or limited CLI commands when connecting through the serial port via the Terminal Profile. The CLI commands are limited to those used for initiating a session. If connection to the IOLAN is done with Telnet from the network, the user will be presented with the Easy Port Access menu.● Menu—The menu level user will only be able to access predefined session when connecting through a serial port with the Terminal profile or will be limited to the Easy Port Access menu when connecting from the network. The Easy Port Access allows the user to connect to the accessible line without disconnecting their initial connection to the IOLAN. Does not have any access to CLI commands. <p>When the Admin user logs into the IOLAN, the prompt ends with a #, whereas all other users' prompts ends with a \$ or £, depending on the character set.</p> <p>Default: Normal</p>
--------------	---

Note: A technique for giving a serially attach user (dial-in or terminal attached), the same menus as one that is network connected is to do the following:

1. Define the serial port with a Terminal Profile using telnet protocol with a direct connection to Host IP address 127.0.0.0 (local loop back).
2. When the user connects to that serial port a Telnet session will be established to the IOLAN and the user will appear to have connected from the network.

Services Tab

Overview

The **Services** tab configures the connection parameters for a user. Any connection parameters configured in this window will override the serial port connection parameters.

Functionality

When a **Terminal** profile is set for the serial port and **Require Login** has been selected, user's accessing the IOLAN through the serial port will be authenticated. Once authentication is successful, the IOLAN will start a Telnet connection to the specified **Host IP/TCP Port**.

Within the **Terminal** profile, there are a number of settings that apply to possible **Services**. Once it is known which user is connected, and which service is to be used, then the settings from both the **Terminal** profile and the user are used. User parameters take precedence over serial port parameters.

Field Descriptions

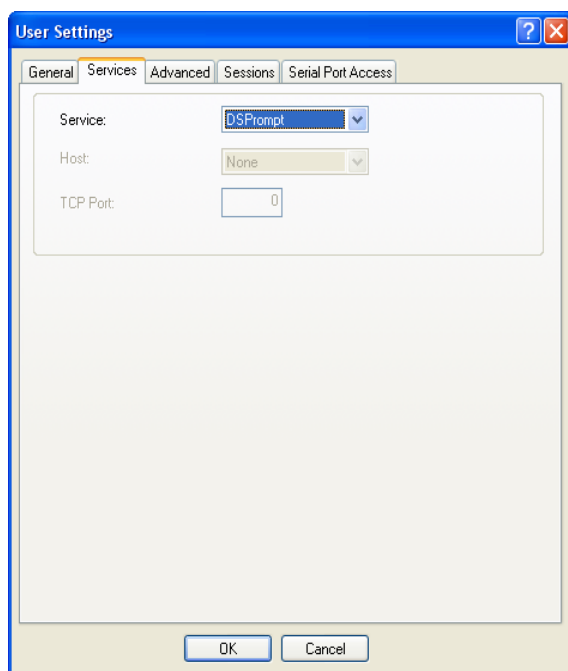

Configure the following parameters:

- | | |
|-----------------|---|
| Service | Used in conjunction with the Terminal Profile . After the user has successfully been authenticated, the specified service is started.
Data Options: DSPrompt, Telnet, TCP Clear
Default: DSPrompt |
| Host IP | When the User Service is set to Telnet or TCP Clear , the target host IP address. If no IP address is specified, the Host IP value in the Default User configuration will be used.
Default: 0.0.0.0. |
| TCP Port | When the User Service is Telnet , this is the target port number. The default value will change based on the type of Service selected; the most common known port numbers are used as the default values. |

Advanced Tab

Overview

The **Advanced** tab is used to configure those parameters that control the user session; this includes session length, language, the hotkey used for switching between sessions.

Field Descriptions

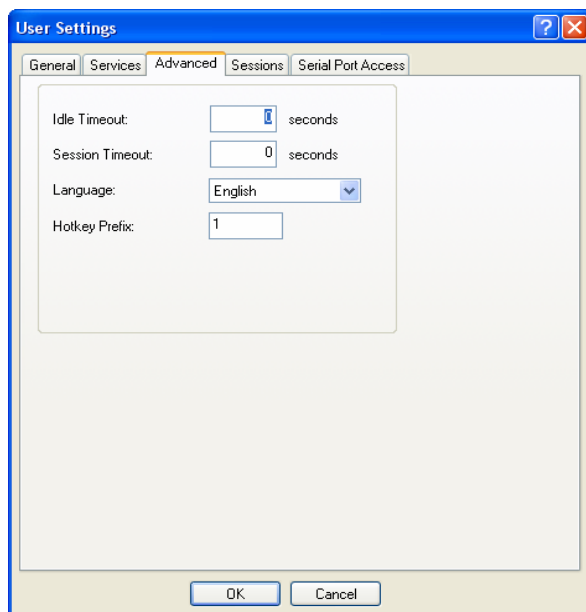

Configure the following parameters:

- Idle Timeout** The amount of time, in seconds, before the IOLAN closes a connection due to inactivity. The default value is **0** (zero), meaning that the **Idle Timer** will not expire (the connection is open permanently). The **User Idle Timeout** will override all other **Serial Port Idle Timeout** parameters.
Range: 0-4294967
Default: 0
- Session Timeout** The amount of time, in seconds, before the IOLAN forcibly closes a user's session (connection). The default value is **0** (zero), meaning that the session timer will not expire (the session is open permanently, or until the user logs out). The **User Session Timeout** will override all other **Serial Port Session Timeout** parameters.
Range: 0-4294967
Default: 0
- Language** You can specify whether a user will use **English** or **Custom Language** as the language that appears in the Menu or CLI. The IOLAN supports one custom language that must be downloaded to the IOLAN.
Default: English
 See [Language Support](#) for more information about Custom Languages.

Hotkey Prefix

The prefix that a user types to control the current session.

Data Options:

- **^a number**—To switch from one session to another, press **^a** (Ctrl-a) and then the required session number. For example, **^a 2** would switch you to session 2. Pressing **^a 0** will return you to the IOLAN Menu.
- **^a n**—Display the next session. The current session will remain active. The lowest numbered active session will be displayed.
- **^a p**—Display the previous session. The current session will remain active. The highest numbered active session will be displayed.
- **^a m**—To exit a session and return to the IOLAN. You will be returned to the menu. The session will be left running.
- **^a l**—(Lowercase L) Locks the serial port until the user unlocks it. The user is prompted for a password (any password, excluding spaces) and the serial port is locked. The user must retype the password to unlock the serial port.
- **^r**—When you switch from a session back to the Menu, the screen may not be redrawn correctly. If this happens, use this command to redraw it properly. This is always **Ctrl R**, regardless of the **Hotkey Prefix**.

The **User Hotkey Prefix** value overrides the **Serial Port Hotkey Prefix** value. You can use the **Hotkey Prefix** keys to lock a serial port only when the serial port's **Allow Port Locking** parameter is enabled.

Default: Hex 01 (Ctrl-a or ^a)

Sessions Tab

Overview

The **Sessions** tab is used to configure specific connections for users who are accessing the network through the IOLAN's serial port.

Functionality

Users who have successfully logged into the IOLAN (**User Service** set to **DSprompt**) can start up to four login sessions on network hosts. These users start sessions through the EasyPort Menu option **Sessions**.

Multiple sessions can be run simultaneously to the same host or to different hosts. Users can switch between different sessions and also between sessions and the IOLAN using **Hotkey** commands (see [Hotkey Prefix](#) for a list of commands).

Users with **Admin** or **Normal** privileges can define new sessions and use them to connect to Network hosts; they can even configure them to start automatically on login to the IOLAN. **Restricted** and **Menu** users can only start sessions predefined for them in their user configuration.

Field Descriptions

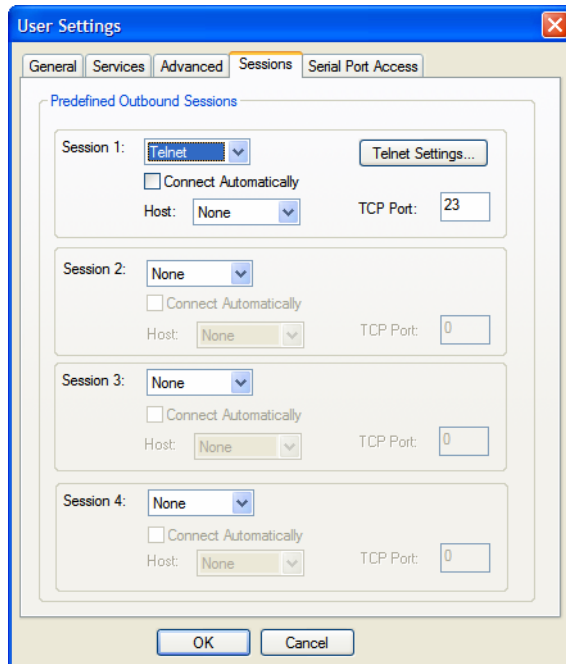

Configure the following parameters:

Session 1, 2, 3, 4 You can configure up to four (4) sessions that the user can select from to connect to a specific host after that user has successfully logged into the IOLAN (used only on serial ports configured for the **Terminal** profile).

Data Options:

- **None**—No connection is configured for this session.
- **Telnet**—For information on the Telnet connection window, see [Telnet Settings](#).

Default: None

Settings Button Click this button to configure the connection parameters for this session.

Connect Automatically Specify whether or not the session(s) will start automatically when the user logs into the IOLAN.

Default: Disabled

Host The host that the user will connect to in this predefined session.

Default: None

TCP Port The TCP port that the IOLAN will use to connect to the host in this predefined session.

Default: 23

Serial Port Access Tab

Overview

The **Serial Port Access** tab controls the user's read/write access on any given IOLAN serial port. This pertains to users that are connecting from the network to a serial device over a Console Management type session.

This can be useful when you have multiple users connecting to the same serial device and you wish to control the viewing and/or the write to and from the device. See **User Authentication** parameters in the *Console Management Profile* for the serial port settings.

Field Descriptions

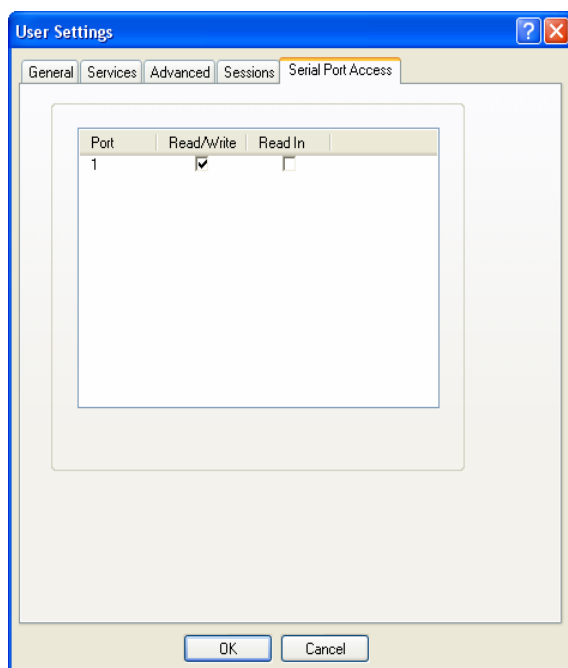

Configure the following parameters:

Serial Port Access Specifies the user access rights to each IOLAN serial port device. There can be multiple users connected to a particular serial device and these settings determine the rights of this user for any of the listed serial ports.

Data Options:

- **Read/Write**—The user has read and write access to the serial port.
- **Read In**—The User will see data going to the serial port, from all network-connected users that have write privileges to this serial port.
- **Read Out**—The user will have access to all data originating from the serial device.

Users can read data going in both directions by selecting both the **Read In** and **Read Out** options.

Default: Read/Write

9

Configuring Security

Introduction

The **Security** group includes the following configuration options:

- **Services**—This configuration window is used to enable/disable client and daemon services that run in the IOLAN. See [Services](#) for more information.



Services

Overview

Services are either daemon or client processes that run on the IOLAN. You can disable any of the services for security reasons.

Functionality

If you disable any of the daemons, it can affect how the IOLAN can be used or accessed. For example, if you disable the WebManager service, you will not be able to access the IOLAN with the WebManager. If you disable the DeviceManager service, the DeviceManager will not be able to connect to the IOLAN. If you do not want to allow users to Telnet to the IOLAN, you can disable the Telnet Server service; therefore, disabling daemons can also be used as an added security method for accessing the IOLAN.

By default, all daemon and client applications are enabled and running on the IOLAN.

Field Descriptions

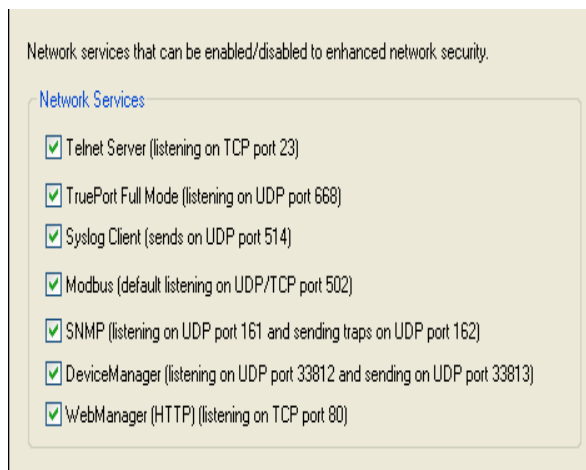

Enable/disable the following options:

Telnet Server	Telnet daemon process in the IOLAN listening on TCP port 23.
TruePort Full Mode	The TruePort daemon process in the IOLAN that supports TruePort Full Mode on UDP port 668. You can still communicate with the IOLAN in Light Mode when this service is disabled.
Syslog Client	Syslog client process in the IOLAN.
Modbus	Modbus daemon process in the IOLAN listening on port 502.
SNMP	SNMP daemon process in the IOLAN listening on port 161 and sending on port 162.
DeviceManager	DeviceManager daemon process in the IOLAN. If you disable this service, you will not be able to connect to the IOLAN with the DeviceManager application. The DeviceManager listens on port 33812 and sends on port 33813.
WebManager (HTTP)	WebManager daemon process in the IOLAN listening on port 80.

Note: TCP ports 2601, 2602 and 2603 are used internally by the IOLAN.

10

Configuring I/O Interfaces

Introduction

There is a line of IOLANs that can control/monitor the following types of I/O:

- Analog Input
- Digital Input/Output
- Relay Output
- Temperature Input

Some of the models are I/O combinations and some of the models support one I/O type.

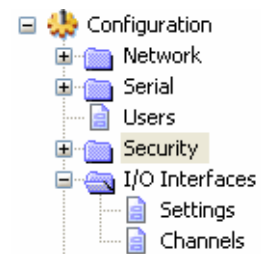

Technical Specifications

Digital I/O

- 2 or 4 channels depending on model
- software selectable as inputs or outputs
- optical isolation of 2000V rms

Digital Input

- Dry Contact: Logic 0 = open. Logic 1 = close to GND
- Wet Contact: Logic 0 = 0-3V. Logic 1 = 10V-30V

Digital Output

- Open collector to 30V (source, sink or both)
- 200mA max load
- Digital out (DO) or pulse mode

Relay

- Form C type SPDT
- Contact rating: 1A@30VDC, 0.5A@AC: 120VAC
- Breakdown voltage: 500 VAC (50/60 Hz)
- Relay on time: 7 msec. Relay off time 3 msec
- Total switching time: 10 msec
- Insulation resistance: 1000 MW minimum at 500 VDC

Settings

Overview

The **I/O Interfaces Settings** window configures the parameters that are global to all I/O channels.

I/O Access Functionality

Field Descriptions

Configure the following parameters:

Enable I/O Access to Modbus protocol Enables/disables Modbus as the communication protocol for all the I/O channels.

Default: Disabled

UID This is the UID you are assigning to the IOLAN, which is acting as a Modbus slave.

Default: 255

Advanced Modbus Settings Button Click this button to configure global Modbus Slave settings. See [Advanced Slave Modbus Settings](#) for field descriptions.

Allow Modbus TCP Application (API) Allows a host running a Modbus/TCP application to communicate to the I/O channels using the standard Modbus API.

Default: Permanently enabled when **Enable I/O Access via Modbus protocol** is enabled

See [Modbus I/O Access](#) for function codes and I/O coil/registration descriptions.

Allow Modbus RTU/ASCII via TruePort Enables/disables serial Modbus application access to the I/O over the network using the TruePort COM redirector feature.

Default: Disabled

See [Modbus I/O Access](#) for function codes and I/O coil/registration descriptions and [Accessing I/O Data Via TruePort](#) for the Perle API.

- Idle Timeout** Use this timer to close a connection because of inactivity. When the **Idle Timeout** expires, the IOLAN will end the connection.
Range: 0-4294967 seconds (about 49 days)
Default: 0 (zero), which does not timeout, so the connection is permanently open.
- Enable Modbus Exceptions** When enabled, an exception message is generated and sent to the initiating Modbus device when any of the following conditions are encountered: there is an invalid UID, the UID is not configured in the Gateway, there is no free network connection, there is an invalid message, or the target device is not answering the connection attempt.
Default: Enabled
- Enable I/O Access via TruePort** Enables/disables serial application access to the I/O over the network using the TruePort COM redirector feature.
Default: Disabled
- Listen TCP Port** The TCP port that the IOLAN will listen to for I/O channel data requests from TruePort.
Default: 33816
- Allow I/O Access via API through TruePort** Allows serial application access to the I/O over the network using the TruePort COM redirector feature via a custom application using the Perle API.
Default: Permanently enabled when **Enable I/O Access via TruePort** is enabled
 See [Modbus I/O Access](#) for function codes and I/O coil/registration descriptions and [Accessing I/O Data Via TruePort](#) for the Perle API.

Advanced Slave Modbus Settings

The parameters in this window configure global Modbus gateway settings that apply to all serial ports configured first as the **Modbus Gateway** profile and then as a **Modbus Slave**.

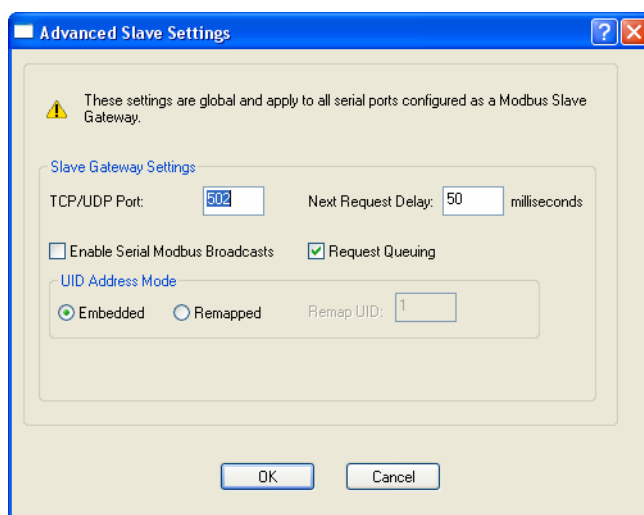

Configure the following parameters:

- TCP/UDP Port** The network port number that the Slave Gateway will listen on for both TCP and UDP messages.
Default: 502

- Next Request Delay** A delay, in milliseconds, to allow serial slave(s) to re-enable receivers before issuing next Modbus Master request.
Range: 0-1000
Default: 50 ms
- Enable Serial Modbus Broadcasts** When enabled, a UID of 0 (zero) indicates that the message will be broadcast to all Modbus Slaves.
Default: Disabled
- Request Queuing** When enabled, allows multiple, simultaneous messages to be queued and processed in order of reception.
Default: Enabled
- Embedded** When this option is selected, the address of the slave Modbus device is embedded in the message header.
Default: Enabled
- Remapped** Used for single device/port operation. Older Modbus devices may not include a UID in their transmission header. When this option is selected, you can specify the UID that will be inserted into the message header for the Modbus slave device. This feature supersedes the Broadcast feature.
Default: Disabled
- Remap UID** Specify the UID that will be inserted into the message header for the Slave Modbus serial device.
Range: 1-247
Default: 1

Failsafe Timer Functionality

Overview

The **Failsafe Timer** tab configures the I/O failsafe timer. The Failsafe Timer is enabled on a global basis and provides a trigger mechanism that can be configured for each channel when no I/O traffic has occurred for the specified amount of time. This traffic information would include any statistical data updates based on the refresh timer for Statistics. A Failsafe Action can be configured for each Digital Output channel, each Serial Signal Output pin (DTR and RTS), and each Relay channel to either Activate or Deactivate the output.

The Failsafe Timer has a different function when I/O Extension is enabled for Digital Output channels, Relay channels, or the Serial Signal Output pins (DTR and RTS). For I/O Extension, the Failsafe Timer provides a per channel or per serial signal output pin trigger mechanism that is activated when there are no TCP sessions for the specified amount of time.

Field Descriptions

Configure the following parameters:

Enable I/O Failsafe Timer	Enables/disables the Failsafe Timer . This is the global setting that must be enabled to set the Failsafe Action on the channel for digital output and relay channels or output signal pins. When this timer expires because of no I/O activity within the specified time interval, the Failsafe Action set for the channel determines the action on the output. When the channel or serial signal pin is configured for I/O extension, the timer expires there are no TCP sessions for the specified time interval. Default: Disabled
Timeout	The number of seconds that must elapse before the channel/serial signal pin Failsafe Action is triggered. Range: 1-9999 Default: 30 seconds

UDP Functionality

Overview

The **UDP** tab configures the I/O UDP broadcast settings. The I/O UDP broadcast feature periodically broadcasts the I/O channel status in a UDP message.

You can configure up to four sets of IP address entries (each entry consisting of a start and end IP address range) to broadcast I/O status data. The broadcast frequency of the UDP packets to the configured UDP IP addresses can be defined to accommodate network traffic and monitoring PC application requirements. For details of the UDP I/O datagram see [I/O UDP](#).

Field Descriptions

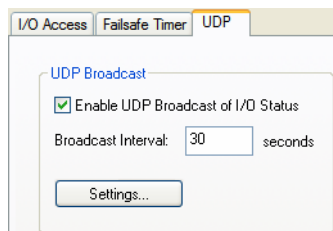

Configure the following parameters:

Enable UDP Broadcast of I/O Status	Enables/disables UDP broadcast of I/O channel status (data). Default: Disabled
Broadcast Interval	Enter the interval, in seconds, for UDP broadcasts of I/O channel status (data). Range: 1-9999 Default: 30 seconds
Settings Button	Click this button to configure the UDP IP addresses that will receive the I/O status information. See I/O UDP Settings for field descriptions for the I/O UDP Settings window.

I/O UDP Settings

Configure the following parameters:

- | | |
|-------------------------|---|
| UDP Entry | When enabled, broadcasts I/O status (data) to the specified range of IP addresses.
Default: Disabled |
| Start IP Address | The first host IP address in the range of IP addresses (for IPV4 or IPV6) that the IOLAN will listen for messages from and/or send messages to. |
| End IP Address | The last host IP address in the range of IP addresses (for IPV4, not required for IPV6) that the IOLAN will listen for messages from and/or send messages to. |
| Port | The UDP port that the IOLAN will use to relay messages to servers/hosts.
Default: 0 (zero) |

Temperature Functionality

Overview

The **Temperature** tab configures the temperature scale settings for T4 models.

Field Descriptions

Configure the following parameter:

- | | |
|--------------------------|--|
| Temperature Scale | Select the temperature scale that will be used to display temperature data.
Data Options: Fahrenheit or Celsius
Default: Celsius |
|--------------------------|--|

Channels

The **Channels** section displays the I/O Channels window, through which you can enable/disable the I/O channels.

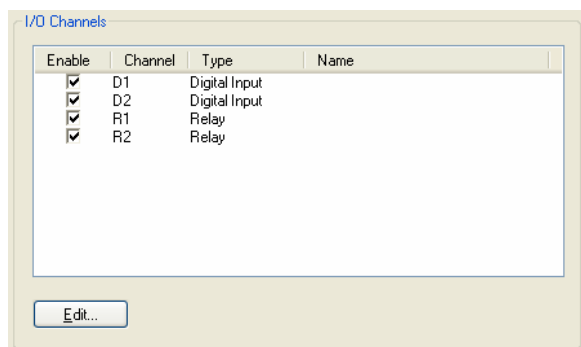

Highlight a channel and then click the **Edit** button to configure the parameters for that channel.

Analog

Overview

Analog channels monitor current/voltage input. Note that the internal jumpers must match the software setting (by default, they are set to Current); see [Analog Input Module](#) to find out how to set the internal jumpers.

For example, in an industrial freezer warehouse, the IOLAN A4R2 is used to monitor humidity transducers, which are in place to help prevent freezer burn. If the humidity reaches a certain percentage (monitored by an Analog channel) a syslog message is sent to the Monitoring Application. The Monitoring Application then sends a command to the IOLAN via the Perle API that causes the Relay channel to activate an internal freezer dehumidifier. The relay is turned off when the Analog channel sends a clear syslog message to the Monitoring Application and the Relay channel is deactivated.

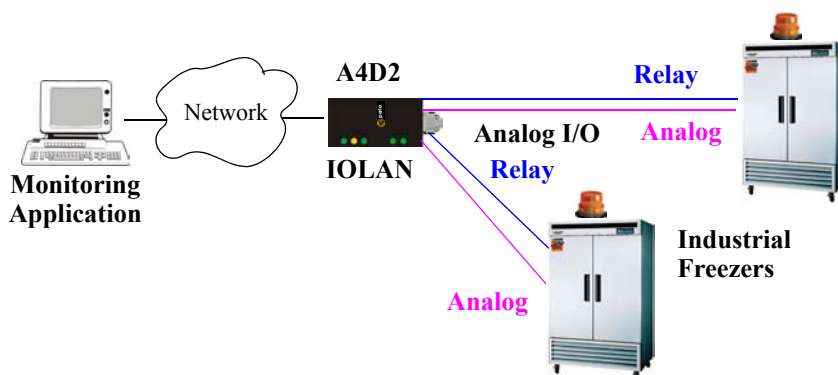

Field Descriptions

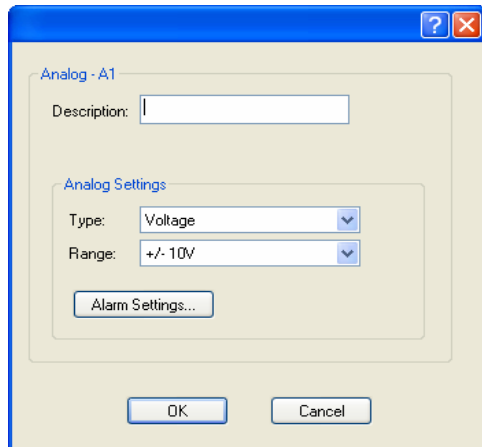

Configure the following parameters:

- | | |
|------------------------------|--|
| Description | Provide a description of the channel, making it easier to identify.
Data Options: Maximum 20 characters, including spaces |
| Type | Select the type of input being measured.
Data Options: Current or Voltage
Default: Current |
| Range | Select the range for the measurement type.
Data Options: <ul style="list-style-type: none"> ● Current—0-20 mA, 4-20 mA ● Voltage—+/- 10V, +/- 5V, +/- 1V, +/- 500mV, +/- 150mV Default: Current is 0-20 mA. Voltage is +/- 10V. |
| Alarm Settings Button | Click the Alarm Settings button to specify the trigger and clear levels for the alarms. Notice that the Analog Alarm Settings window has two alarm configuration views, a basic alarm view and an advanced alarm view.

See Alarm Settings for field descriptions. |

Digital Input

Overview

When the channel is set for digital input, it monitors voltage or current. Note that the internal jumpers must match the software setting and must be set to Input, which is the default; see [Digital I/O Module](#) to find out how to set the internal jumpers.

Functionality

The Digital input channels allow you to configure the following options:

- You can choose to remember the last state change, or latch, that occurred. Your options are to latch (remember) when the state changes from inactive to active or active to inactive.
- You can choose to invert the signal, which is useful if your sensor is wired in such a way that closed is actually inactive, whereas closed is normally considered active.
- You can also configure an alarm trigger and clear mode based on whether the Digital input is active or inactive, sending a syslog message and/or SNMP trap when the alarm is triggered or cleared.

In an industrial freezer warehouse example, a D4 is used to monitor the open door sensor, so that every time a freezer door is opened, an alarm is triggered and a syslog message is sent to a syslog server, where the monitoring application notes the time.

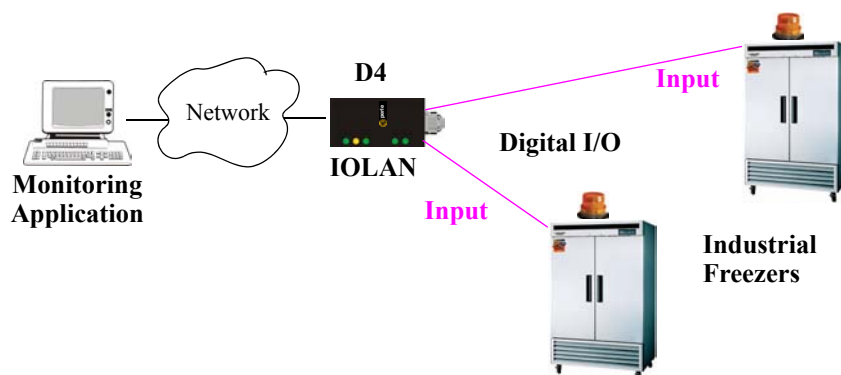

Field Descriptions

Configure the following parameters:

- | | |
|----------------------|--|
| Description | Provide a description of the channel, making it easier to identify.
Data Options: Maximum 20 characters, including spaces |
| Input Mode | When selected, the channel will be reading the status of the line (input). The internal jumpers must match the software configuration; the internal jumpers are factory configured for Input Mode .
Default: Input Mode |
| Latch | Latches (remembers) the activity transition (active to inactive or inactive to active).
Data Options: None, Inactive-to-Active, Active-to-Inactive
Default: None |
| Invert Signal | When enabled, inverts the actual condition of the I/O signal in the status; therefore, an inactive status will be displayed as active.
Default: Disabled |
| Trigger | When the trigger condition is met, triggers the specified alarm action.
Data Options: <ul style="list-style-type: none"> ● Disabled—No alarm settings. This is the default. ● Inactive—When the expected Digital input is active, going inactive will trigger an alarm. ● Active—When the expected Digital input is inactive, going active will trigger an alarm. Default: Disabled |

Auto Clear Mode	When enabled, automatically clears the alarm when the trigger condition changes; for example, if the Trigger is Inactive and the alarm is triggered, once the input becomes active again, the alarm will automatically be cleared Default: Enabled
Manual Clear Mode	When enabled, a triggered alarm must be manually cleared. Default: Disabled
Syslog	When enabled, sends a message to syslog when an alarm is triggered or cleared. The syslog entry includes the severity level and the value that caused the alarm to trigger or clear. The syslog message is associated with Level Critical . Default: Disabled
SNMP	When enabled, sends an SNMP trap when an alarm is triggered or cleared. The trap consists of the severity level and whether the alarm was triggered or cleared. Default: Disabled

Digital Output

Overview

When the channel is set for digital output, either voltage is applied to the channel or the channel is grounded. Note that the internal jumpers must match the software setting and must be set to Output (by default, they are set to Input); see [Digital I/O Module](#) to find out how to set the internal jumpers.

Functionality

The Digital output channels support three types of Digital output: sink (voltage), source (ground), and sink and source (apply voltage or ground). For the output type, you can configure the following options:

- You can choose to manually activate/deactivate the Digital output.
- You can choose to manually activate/deactivate the Digital output and then specify that the Digital output will either pulse (you get to specify the active and inactive pulse times) continuously or for a specified number of pulse counts.
- You can choose to manually activate/deactivate the Digital output and then specify a delay before the output goes from inactive to active or active to inactive.
- You can also specify a failsafe action that can either activate or inactivate the Digital output when the failsafe timer is triggered (see [Failsafe Timer Functionality](#) for more information).

In an industrial freezer warehouse, the IOLAN D4 is used to monitor the freezer doors. When one of the industrial freezer doors are left open for more than five minutes, the Monitoring Application (using the Perle API) starts the Digital output sink, causing the strobe light on top of the offending freezer to activate.

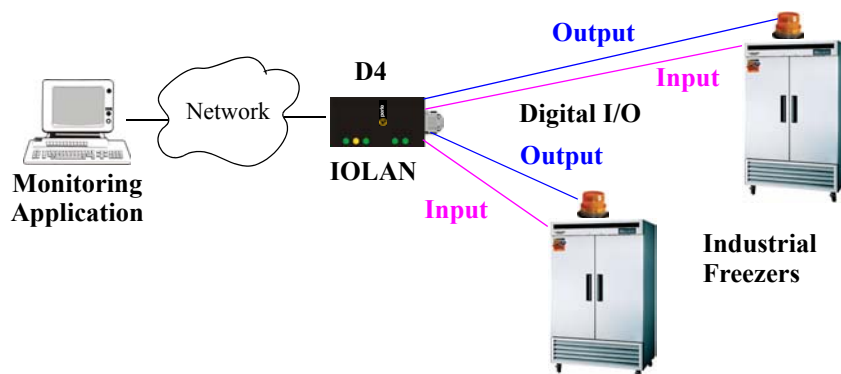

Field Descriptions

Configure the following parameters:

- Description** Provide a description of the channel, making it easier to identify.
Data Options: Maximum 20 characters, including spaces
- Output Mode** When selected, the channel will drive the line (output). The internal jumpers must match the software configuration, so if you change this setting to **Output Mode**, you will have to also change the internal hardware jumpers.
Default: Disabled
- Type** Specify the type of digital output.
Data Options:
- **Sink**—Specifies that the channel will be grounded when active.
 - **Source**—Specifies that the channel will provide voltage when active.
 - **Sink and Source**—Specifies that channel will be grounded when it is inactive and will provide voltage when it is active.
- Default:** Sink

Output	<p>Specify how the channel output will be handled.</p> <p>Data Options:</p> <ul style="list-style-type: none">● Manual—You must manually manipulate the channel output.● Pulse—Activates and deactivates the channel output activity in intervals after it is manually activated.● Inactive-to-Active Delay—The channel output will remain inactive for the specified time interval after it is manually started.● Active-to-Inactive Delay—The channel output will go inactive after the specified time interval after it is manually started. <p>Default: Manual</p>
Pulse Mode	<p>When Output is set to Pulse, you can specify the manner of the pulse.</p> <p>Data Options:</p> <ul style="list-style-type: none">● Continuous—Continuously pulses active and inactive.● Count—Pulses an active/inactive sequence for the specified number of times. <p>Default: Continuous</p>
Pulse Count	<p>The channel output will pulse for the specified number of times; each count consists of an active/inactive sequence.</p> <p>Default: 1</p>
Inactive Signal Width	<p>How long the channel will remain inactive during pulse mode.</p> <p>Range: 1-9999 x 100 ms</p> <p>Default: 1 (100 ms)</p>
Active Signal Width	<p>How long the channel will be active during the pulse mode.</p> <p>Range: 1-9999 x 100 ms</p> <p>Default: 1 (100 ms)</p>
Delay	<p>When a deactivate command is issued, a delay is implemented before the command is executed.</p> <p>Range: 1-9999 x 100 ms</p> <p>Default: 1 (100 ms)</p>
Failsafe Action	<p>When there has been no I/O activity within the specified time (set in the I/O Interfaces, Settings on the Failsafe Timer tab) and the Failsafe Timer is triggered.</p> <p>Data Options:</p> <ul style="list-style-type: none">● None—The state of the Digital/Relay output remains the same, no change.● Activate Output—Activates the channel.● Deactivate Output—Deactivates the channel. <p>Default: None</p>

Relay

Overview

Relay channels can open or close a contact for a higher voltage circuit using a lower level control voltage. The Relay output channels work as a physical on/off switch, and are used to drive higher voltage devices with a lower controlling voltage.

You can configure the following Relay output channel options:

- You can choose to manually activate/deactivate the Relay output.
- You can choose to manually activate/deactivate the Relay output and then specify that the Relay output will either pulse (you get to specify the active and inactive pulse times) continuously or for a specified number of pulse counts.
- You can choose to manually activate/deactivate the Relay output and then specify a delay before the output goes from inactive to active or active to inactive.
- You can also specify a failsafe action that can either active or inactivate the Relay output when the failsafe timer is triggered (see [Failsafe Timer Functionality](#) for more information).

In an industrial freezer warehouse, the IOLAN A4D2 is used to monitor humidity transducers, which are used to help prevent freezer burn. If the humidity reaches a certain percentage (monitored by an Analog channel) a syslog message is sent to the Monitoring Application, causing the Relay channel to activate an internal freezer dehumidifier. The Relay channel is deactivated when the Analog channel sends a clear syslog message to the Monitoring Application and the Relay channel is deactivated.

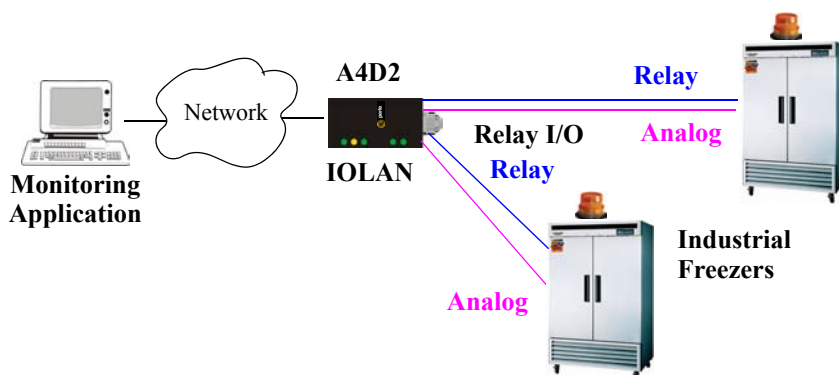

Field Descriptions

Configure the following parameters:

- Description** Provide a description of the channel, making it easier to identify.
Data Options: Maximum 20 characters, including spaces
- Output** Specify how the channel output will be handled.
Data Options:
- **Manual**—You must manually manipulate the channel output.
 - **Pulse**—Activates and deactivates the channel output activity in intervals after it is manually activated.
 - **Inactive-to-Active Delay**—The channel output will remain inactive for the specified time interval after it is manually started.
 - **Active-to-Inactive Delay**—The channel output will go inactive after the specified time interval after it is manually started.
- Default:** Manual
- Pulse Mode** When **Output** is set to **Pulse**, you can specify the manner of the pulse.
Data Options:
- **Continuous**—Continuously pulses active and inactive.
 - **Count**—Pulses an active/inactive sequence for the specified number of times.
- Default:** Continuous
- Pulse Count** The channel output will pulse for the specified number of times; each count consists of an active/inactive sequence.
Default: 1
- Inactive Signal Width** How long the channel will remain inactive during pulse mode.
Range: 1-9999 x 100 ms
Default: 1 (100 ms)

Active Signal Width	How long the channel will be active during the pulse mode. Range: 1-9999 x 100 ms Default: 1 (100 ms)
Delay	When a deactivate command is issued, a delay is implemented before the command is executed. Range: 1-9999 x 100 ms Default: 1 (100 ms)
Failsafe Action	When there has been no I/O activity within the specified time (set in the I/O Interfaces, Settings on the Failsafe Timer tab) and the Failsafe Timer is triggered. Data Options: <ul style="list-style-type: none"> • None—The state of the Digital/Relay output remains the same, no change. • Activate Output—Activates the channel. • Deactivate Output—Deactivates the channel. Default: None

Digital I/O Extension

Overview

The Digital I/O extension feature connects a digital input signal to digital output(s)/relay(s) and/or a TCP/IP application over an IP network. Therefore, when the state of the digital input changes, you can also change the state of the digital output or relay channel or output serial signal pin on a local I/O channel(s), other IOLAN I/O channels, other IOLAN serial signal pins, or the data can be sent to an application(s).

For example, when the door opens (I/O digital input sensor) in a factory, a light goes on in the reception office (remote IOLAN relay channel), and the door open/close is logged by an application on a remote host.

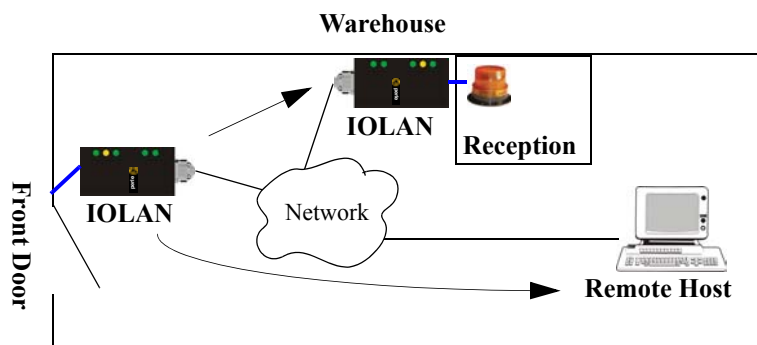

Functionality

The Digital I/O extension feature requires the digital input to be connected to one or more digital outputs/relays (local or on another IOLAN model), output serial signal pins, and/or TCP/IP applications. In order to create a successful connection between the input and output or application, one side must be set to **Listen for connection** and the other side must be set to **Connect to**. When the state of an input channel changes, a message is sent to all sessions currently associated with that channel.

When the IOLAN is communicating to an application, there is no need for the output channel or application to respond to messages from the input channel. Each input channel is reported individually, so the receiving application gets the status only at the point at which the channel state has changed.

The message format (from input channel to output channel/application) consists of 20 bytes per status; 10 bytes are currently used and 10 are being reserved for future use.

Message Type (1 Byte)	Input Number (1 Byte)	IOLAN MAC Address (6 Bytes)	Current Alarm State (1 Byte)	Current Status of Input (1 Byte)	Reserved (10 Bytes)
--------------------------	--------------------------	--------------------------------	---------------------------------	-------------------------------------	------------------------

- **Message type:** (1 Byte)
 - 0 = Digital input status
 - 1 = Serial I/O status
- **Input number:** (1 Byte)
 - Digital input will be 1, 2, 3, or 4 to represent the channel number
 - Serial I/O will be 5 = DSR, 6 = DCD, or 7 = CTS
- **MAC Address** of the IOLAN sending the input information. (6 Bytes)
- **Current Alarm State:** (1 Byte)
 - 0 = Not in alarm
 - 1 = In Alarm
- **Current Status of Input:** (1 Byte)
 - 0 = Inactive for digital input.
 - 1 = Active for digital input.
- **Reserved for future use.** Reserved bytes will have the value 0x00. (10 Bytes)

Applications should be written in such a way so that they look at the Message type byte to determine the format of the message. If the application encounters a Message type it does not recognize, it should discard the message and read the next 20 byte block.

Field Descriptions

The **Local connection** option is different depending on whether you are configuring a Digital Input or a Digital Output/Relay channel. The **Local connection** option for Digital Input lists all the local Digital Output channels or output serial signal pins that it is associated with. Digital Input can be connected to multiple local Digital Output or Relay channels or output serial signal pins. However, a Digital Output can only be associated with one Digital Input channel or input serial signal pin. The **Local connection** option for Digital Output configures the specific local Digital Input channel or input serial signal pin on the same IOLAN that it is to be connected to.

Digital Input/DSR/DCD/CTS

The screenshot shows the 'I/O Extension' tab for a Digital Input channel. The 'Enable I/O extension' checkbox is checked. Under 'Connection Settings', the 'Listen for connection' radio button is selected. The 'Input TCP Port' is set to 20000. The 'Allow Multiple Hosts to Connect' checkbox is unchecked. The 'Connect to' radio button is selected, with 'Host name' set to 'None' and 'TCP Port' set to 20000. The 'Local connection' radio button is unselected, and 'Output Channels' is set to 'No Channels'. The 'Advanced TCP Settings' section has the 'Enable TCP Keepalive' checkbox unchecked.

Digital Output/Relay/DTR/RTS

The screenshot shows the 'I/O Extension' tab for a Digital Output/Relay channel. The 'Enable I/O extension' checkbox is checked. Under 'Connection Settings', the 'Listen for connection' radio button is selected. The 'Output TCP Port' is set to 20000. The 'Connect to' radio button is selected, with 'Host name' set to 'None' and 'TCP Port' set to 20000. The 'Local connection' radio button is unselected, and the 'Input Channel' is set to 'D1'. The 'Advanced TCP Settings' section has the 'Enable TCP Keepalive' checkbox unchecked.

Configure the following parameters:

Enable I/O extension

When enabled, the digital channel can be connected to:

- A Digital output or relay (if the I/O model supports relay) channel on the same IOLAN
- Output Serial Signal Pins (DTR/RTS)
- A Digital output channel on another IOLAN(s) or output serial signal pins (DTR/RTS) on another IOLAN(s)
- A TCP/IP application(s) running on a host on the network

Default: Disabled

Listen for connection

When enabled, the channel/serial signal pin will wait for connections to be initiated by another I/O channel or a TCP/IP application.

Default: Enabled

Input TCP Port

The TCP port that the channel/serial signal pin will use to listen for incoming connections.

Default: 2000 for channel 1, then increments by one for each channel

Allow Multiple Hosts to Connect

When this option is enabled, multiple I/O channels and/or TCP/IP applications can connect to this channel/serial signal pin.

Default: Disabled

Connect to	When enabled, the channel/serial signal pin initiates communication to another I/O channel or a TCP/IP application. Default: Enabled
Host Name	The configured host or another IOLAN that the I/O channel will connect to. Default: None
TCP Port	The TCP Port that the channel/serial signal pin will use to communicate to another IOLAN or a TCP/IP application. Default: 2000 for channel 1, then increments by one for each channel
Connect to Multiple Hosts	When enabled, input channel or serial signal pin can communicate to multiple hosts running a TCP/IP application or I/O channels. Default: Disabled
Define Additional Hosts Button	Click this button to define the hosts/IOLANs that this channel or serial signal pin will connect to. This button is also used to define the Primary/Backup host functionality.
Local connection	When this option is enabled, the input or output, depending on how the channel or serial signal pin is configured, will be associated with another local IOLAN I/O channel or serial signal pin. <ul style="list-style-type: none">• When the channel is configured as digital input or when configuring an input serial signal pin, the Output Channels parameter displays all the local digital output signals or relays that it is associated with.• When the channel is configured as digital output, you must select a local digital input channel or input serial signal pin on the IOLAN. Note that the Failsafe Action is not compatible this option. Default: Disabled
Enable TCP Keepalive	Enables a per-connection TCP keepalive feature. After the configured number of seconds, the connection will send a gratuitous ACK to the network peer, thus either ensuring the connection stays active OR causing a dropped connection condition to be recognized. This parameter needs to be used in conjunction with Monitor Connection Status Interval parameter found in the Serial, Advanced, Advanced Settings tab. The interval determines how long the IOLAN will wait during inactivity before "testing" the connection. It should be noted that if a network connection is accidentally dropped, it can take as long as the specified interval before anyone can reconnect to the serial port. Default: Disabled

Adding/Editing Additional Hosts

You can define a list of hosts that the I/O channel will communicate to or a primary/backup host.

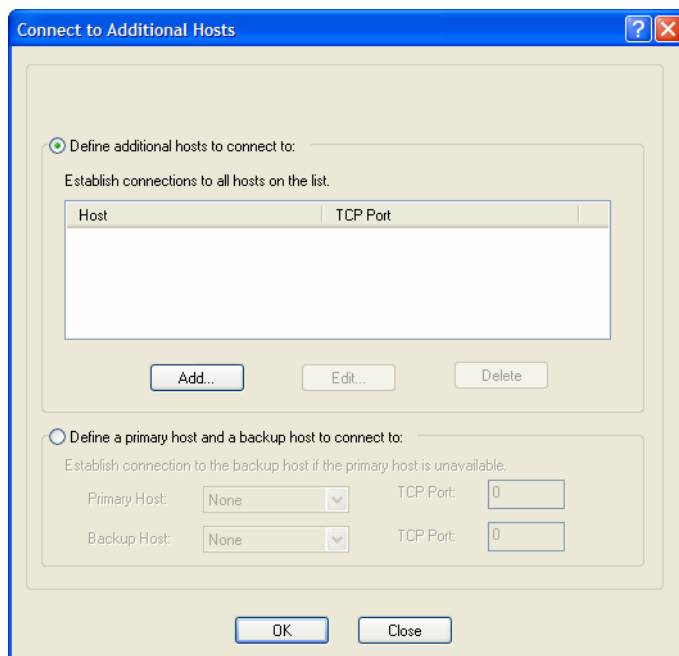

Configure the following parameters:

Define additional hosts to connect to When this option is enabled, you can define up to 49 hosts/IOLANs that the I/O channel or serial signal pin will attempt communicate to. With this mode of operation, the I/O channel will connect to multiple hosts/IOLANs simultaneously.

Default: Enabled

Add Button Click the **Add** button to add a host to the list of hosts that will be receiving communication from the I/O channel or serial signal pin.

Edit Button Highlight an existing host and click the **Edit** button to edit a host in the list of hosts that will be receiving communication from the I/O channel.

Delete Button Click the **Delete** button to delete a host to the list of hosts that will be receiving communication from the I/O channel or serial signal pin.

Define a primary host and backup... When this option is enabled, you need to define a primary host that the I/O channel will communicate to and a backup host, in the event that the I/O channel loses communication to the primary host. The I/O channel will first establish a connection to the primary host. Should the connection to the primary host be lost (or never established), the I/O channel will establish a connection the backup host. Once connected to the backup, the I/O channel will attempt to re-establish a connection to the Primary host, once this is successfully done, it gracefully shuts down the backup connection.

Default: Disabled

Primary Host Specify a preconfigured host that the I/O channel or serial signal pin will communicate to.

Default: None

- TCP Port** Specify the TCP port that the I/O channel or serial signal pin will use to communicate to the **Primary Host**.
Default: 2000 for channel 1, then increments by one for each channel
- Backup Host** Specify a preconfigured host that the I/O channel or serial signal pin will communicate to if the I/O channel cannot communicate with the **Primary Host**.
Default: None
- TCP Port** Specify the TCP port that the channel or serial signal pin will use to communicate to the **Backup Host**.
Default: 0

Adding/Editing a Multihost Entry

When you click the **Add** or **Edit** button, the Host Entry window appears. The hosts in the multihost list must already be defined (see [Host Table](#) to learn how to create a host). If you add a host that was defined with its fully qualified domain name (FQDN), it must be resolvable by your configured DNS server.

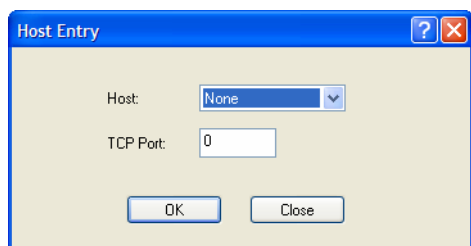

Configure the following parameters:

- Host Name** Specify the preconfigured host that will be in the multihost list.
Default: None
- TCP Port** Specify the TCP port that the I/O channel or serial signal pin will use to communicate to the **Host**.
Default: 0

Temperature

Temperature input channels monitor RTD or thermocouple temperature sensors inputs for the most common ranges. You can also configure severity alarms that can send a syslog message and/or an SNMP trap when an alarm is triggered or cleared; See [Alarm Settings](#) for more information about the alarms.

RTD ranges are:

● Pt100 a=385 -50 to 150C	● Pt100 a=392 -50 to 150C	● Pt1000 a=385 -40 to 160C
● Pt100 a=385 0 to 100C	● Pt100 a=392 0 to 100C	● NiFe604 a=518 -80 to 100C
● Pt100 a=385 0 to 200C	● Pt100 a=392 0 to 200C	● NiFe604 a=518 0 to 100C
● Pt100 a=385 0 to 400C	● Pt100 a=392 0 to 400C	
● Pt100 a=385 -200 to 200C	● Pt100 a=392 -200 to 200C	

Note: IEC RTD 100 ohms.=0.00385
JIS RTD 100 ohms.=0.00392

Thermocouple ranges are:

● B 500 to 1800C	● K 0 to 1370C	● T -100 to 400C
● E 0 to 1000C	● R 500 to 1750C	
● J 0 to 760C	● S 500 to 1750C	

In the following example, a Temperature I/O IOLAN is used to monitor industrial freezer temperature sensors, with an alarm set to send a syslog message if the temperature rises above 31^o C.

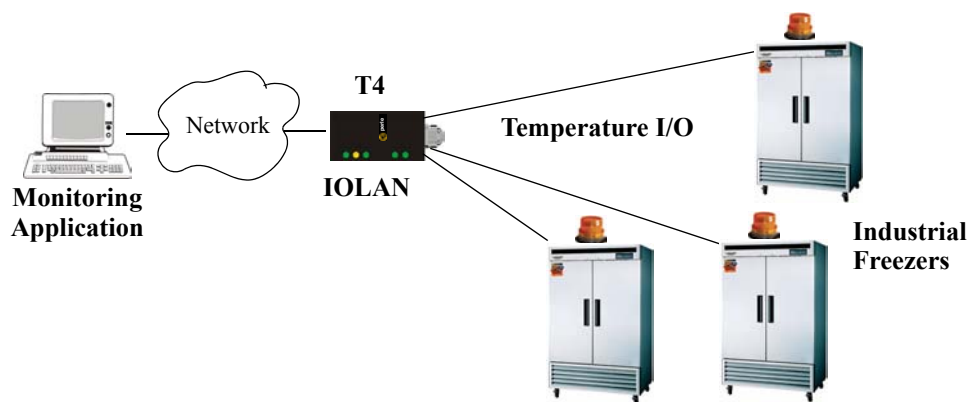

Field Descriptions

The screenshot shows a dialog box titled "Analog - A1". It contains a "Description:" label followed by a text input field. Below this is an "Analog Settings" section containing two dropdown menus: "Type:" set to "RTD" and "Range:" set to "Pt100 a=385 -50 to 150C". There is also an "Alarm Settings..." button. At the bottom of the dialog are "OK" and "Cancel" buttons.

Configure the following parameters:

- | | |
|------------------------------|---|
| Description | Provide a description of the channel, making it easier to identify.
Data Options: Maximum 20 characters, including spaces |
| Type | Specify the type of sensor you are using to measure temperature.
Data Options: RTD, Thermocouple
Default: RTD |
| Range | Specify the temperature range that you want to measure.
Data Options: <ul style="list-style-type: none"> ● RTD—Pt100 a=385 -50 to 150C, Pt100 a=385 0 to 100C, Pt100 a=385 0 to 200C, Pt100 a=385 0 to 400C, Pt100 a=385 -200 to 200C, Pt100 a=392 -50 to 150C, Pt100 a=392 0 to 100C, Pt100 a=392 0 to 200C, Pt100 a=392 0 to 400C, Pt100 a=392 -200 to 200C, Pt1000 a=385 -40 to 160C, NiFe604 a=518 -80 to 100C, NiFe604 a=518 0 to 100C ● Thermocouple—B 500 to 1800C, E 0 to 1000C, J 0 to 760C, K 0 to 1370C, R 500 to 1750C, S 500 to 1750C, T -100 to 400C Default: RTD is Pt100 a=385 -50 to 150C. Thermocouple is J 0 to 760C. |
| Alarm Settings Button | Click the Alarm Settings button to specify the trigger and clear levels for the alarms. Notice that the Analog Alarm Settings window has two alarm configuration views, a basic alarm view and an advanced alarm view.

See Alarm Settings for field descriptions. |

Alarm Settings

Analog and Temperature input models support an Alarm mechanism in which you can specify up to five severity levels of alarm triggers and clear levels; the alarm triggers/clear levels can activate in either increasing or decreasing severity levels.

Each time an alarm is triggered or cleared, you can specify any combination of the following to be initiated:

- An SNMP trap
- A message to syslog

Basic Analog Alarm Settings

The basic Analog Alarm Settings window allows you to configure one severity alarm, whereas the advanced window allows you to configure up to five severity alarm levels.

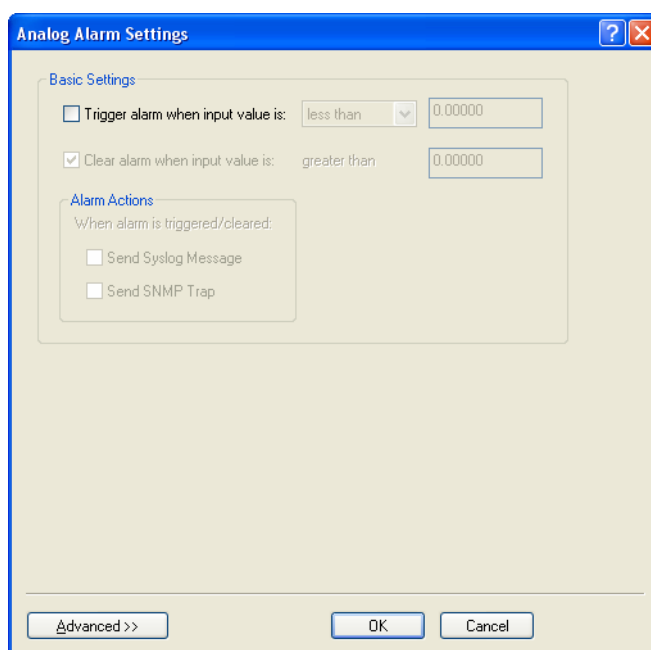

Configure the following parameters:

- | | |
|--|--|
| Trigger alarm when input value is | Specify the value that will trigger an alarm, the measurement is based on the Type and Range that you specify. This value must not fall within the scope of the value used to clear an alarm. |
| Clear alarm when input value is | Specify that value that will clear an alarm, the measurement is based on the Type and Range that you specify. This value must not fall within the scope of the value used to trigger an alarm. |
| Send Syslog Alert | When enabled, sends a message to syslog when an alarm is triggered or cleared. The syslog entry includes the severity level and the value that caused the alarm to trigger or clear. The syslog message is associated with Level Critical .
Default: Disabled |
| Send SNMP Alert | When enabled, sends an SNMP trap when an alarm is triggered or cleared. The trap consists of the severity level and whether the alarm was triggered or cleared.
Default: Disabled |

Advanced Analog Alarm Settings

The advanced Analog Alarm Settings window expands the basic alarm settings options to up to five severity levels.

The screenshot shows the 'Analog Alarm Settings' dialog box. The 'Advanced Settings' section has 'Trigger Type' set to 'Low' and 'Clear Mode' set to 'Auto'. The 'Severity Levels' section is a table with five levels, each with a checkbox, a 'Trigger' value of 0.00000, a 'Clear' value of 0.00000, and checkboxes for 'Syslog' and 'SNMP'. All checkboxes are currently unchecked. At the bottom, there are buttons for '<< Basic', 'OK', and 'Cancel'.

Configure the following parameters:

- Trigger Type** If the **Trigger Type** is **Low**, an alarm is triggered when the input drops below the specified **Trigger** value; other severity level trigger values must decrease in value with each subsequent level. If the **Trigger Type** is **High**, an alarm is triggered when the input is higher than the specified **Trigger** value; other severity level trigger values must increase in value with each subsequent level.
- Clear Mode** To clear an alarm, the input must drop below the specified value when **Trigger Type** is **High** or go above the specified value when **Trigger Type** is **Low**.
- Level 1-5** Defines the Level severity settings for up to five levels. If the **Trigger Type** is **Low**, an alarm is triggered when the input drops below the specified **Trigger** value; other severity level trigger values must decrease in value with each subsequent level. If the **Trigger Type** is **High**, an alarm is triggered when the input is higher than the specified **Trigger** value; other severity level trigger values must increase in value with each subsequent level.
- Trigger** If the **Trigger Type** is **Low**, an alarm is triggered when the input drops below the specified **Trigger** value; other severity level trigger values must decrease in value with each subsequent level. If the **Trigger Type** is **High**, an alarm is triggered when the input is higher than the specified **Trigger** value; other severity level trigger values must increase in value with each subsequent level.
- Clear** To clear an alarm, the input must drop below the specified value when **Trigger Type** is **High** or go above the specified value when **Trigger Type** is **Low**.
- Syslog** When enabled, sends a message to syslog when an alarm is triggered or cleared. The syslog entry includes the severity level and the value that caused the alarm to trigger or clear. The syslog message is associated with **Level Critical**.
Default: Disabled

- SNMP** When enabled, sends an SNMP trap when an alarm is triggered or cleared. The trap consists of the severity level and whether the alarm was triggered or cleared.
Default: Disabled

I/O UDP

Industrial applications often monitor the status of I/O devices such as sensors, alarms, relays, etc. by polling for I/O data. The IOLAN's I/O UDP feature can help to minimize network traffic by broadcasting I/O status to industrial applications on specified intervals, providing I/O status in a timely manner.

The IOLAN's I/O UDP broadcast feature sends the status of attached I/O devices to defined hosts on the network. Depending upon the IOLAN model and the configuration of the I/O channels, the UDP packet contains the current status and/or data of each enabled I/O channel or serial pin signal.

UDP Unicast Format

PC applications must be able to interpret the UDP packet to obtain I/O channel status and data. This section provides the detailed structure of the UDP datagram and its data format.

UDP Broadcast Packet

Version (1 Byte)	Total Packet Length (2 Bytes)	Analog Section	Digital/Relay Section	Serial Pin Signal Section
---------------------	----------------------------------	----------------	-----------------------	---------------------------

Each section, with the exceptions of the Version and Total Packet Length sections, is comprised of its own subset of bytes.

Note: All 2 byte values are in big Endian (network) order. All 4 byte values are IEEE 754 single precision floating point numbers in big Endian (network) order.

- **Version**—The current version of the format of I/O UDP broadcast packet.
- **Total Packet Length**—The total length of the UDP packet.
- **Analog Section**—The Analog Section of the UDP packet, which contains data/status of the Analog I/O channels. The Analog Channel Data subsection (within the Analog Section) will only exist if the channel(s) is enabled.
- **Digital/Relay Section**—The Digital/Relay Section of the UDP packet, which contains status of Digital and Relay I/O channels. The Channel Data subsection within the Digital/Relay Section will always be present.
- **Serial Pin Signal Section**—The Serial Pin Signal Section of the UDP packet, which contains the status of the IOLAN's serial port's control signal pins. The Serial Pin Signal Data subsection within the Serial Signal Pins Section will always be present.

Analog Section

The Analog Section of the UDP packet is comprised of I/O data for each enabled Analog channel.

Note: If the IOLAN I/O model does not support Analog channels, the Analog Channel Data subsection of the Analog Section will NOT be present in the UDP packet.

Section Length	Channel Enabled	Analog Channel Data (for each enabled channel)					
		curRawValue 2 Bytes	minRawValue 2 Bytes	maxRawValue 2 Bytes	curEngValue 4 Bytes	minEngValue 4 Bytes	maxEngValue 4 Bytes
2 Bytes	1 Byte						

- **Section Length**—The total length of the Analog section (this value will vary, the field length is 2 Bytes). This value will vary because it will contain one Analog Channel Data subsection (18 bytes) for each Analog channel that is enabled.
- **Channel Enabled**—The Channel Enabled field is 1 byte in least significant bit order, for each channel. If the channel is enabled, the bit is set to 1. If the channel is disabled, the bit is set to 0 (zero).

Channel Enabled (1 Byte, one bit for each channel)							
				Channel 4	Channel 3	Channel 2	Channel 1

- **Analog Channel Data**—Consists of Analog Channel Data for each enabled Analog channel on the IOLAN. If an Analog channel is disabled, there is no data for that channel. Therefore, the Analog Section will contain the Section Length value, the Channel Enabled value, and 18 bytes of I/O data for each enabled Analog channel. For example, an IOLAN I/O model with four Analog channels that has only three of those Analog channels enabled will contain 54 bytes of Analog Channel Data (18 bytes * 3 Analog channels).

The following values make up the Analog Channel Data for each enabled Analog channel:

- **curRawValue**—The current raw value received by the channel.
- **minRawValue**—The minimum raw value received by the channel until it is cleared.
- **maxRawValue**—The maximum raw value received from the channel until it is cleared.
- **curEngValue**—The current raw value that has been converted to voltage/current for Analog or Celsius/Fahrenheit for Temperature.
- **minEngValue**—The minimum raw value that has been converted to voltage/current for Analog or Celsius/Fahrenheit for Temperature until it is cleared.
- **maxEngValue**—The maximum raw value that has been converted to voltage/current for Analog or Celsius/Fahrenheit for Temperature until it is cleared.

Digital/Relay Section

The Digital/Relay Section of the UDP packet provides the status of Digital and Relay channels. The data for the status of each channel is represented by 1 byte, with each bit representing a channel (least significant bit format).

Note: The Digital/Relay Channel Data subsection is present in the UDP packet regardless of whether or not the IOLAN model supports Digital/Relay channels.

Length	Channel Enabled	Digital/Relay Channel Data (1 Byte, one bit for each channel)							
2 Bytes	1 Byte					Channel 4	Channel 3	Channel 2	Channel 1

- **Length**—The length of Digital/Relay Section within the UDP packet (this value will always be 2 Bytes).
- **Channel Enabled**—This is based on the configuration of the Digital/Relay channels. The Channel Enabled field is 1 byte in least significant bit order, for each channel. If the channel is enabled, the bit is set to 1. If the channel is disabled, the bit is set to 0 (zero).

Channel Enabled (1 Byte, one bit for each channel)							
				Channel 4	Channel 3	Channel 2	Channel 1

- **Digital/Relay Channel Data**—Each bit represents a channel status, 1 for on or 0 for off (unless the channel has been configured to be inverted, in which case 0 is on and 1 if off).

Serial Pin Signal Section

The Serial Pin Signal Section of the UDP packet provides the status of the serial pin signals from the IOLAN's serial port. Each serial pin signal (DSR, DTR, CTS, etc.) is mapped to a bit in the 1-byte data section.

Note: The Serial Pin Signal Data subsection is present in the UDP packet regardless of whether or not the serial port is configured for the **Control I/O** profile or the serial pin signals are enabled.

Length	Pin Enabled	Serial Pin Signal Data (1 Byte, one bit for each signal)							
2 Bytes	1 Byte				RTS	DTR	CTS	DCD	DSR

- **Length**—The total length of the Serial Pin Signal Data (this value will always be 2 Bytes).
- **Pin Enabled**—This based upon the configuration of the signal pins on the serial port. When the serial port profile is set to **Control I/O** and a serial pin signal(s) is enabled, the bit is set to 1. For any serial pin signals that are disabled, the bit is set to 0 (zero) and any data associated with those serial pin signals should be ignored.

Pin Enabled (1 Byte, one bit for each serial pin signal)							
			RTS	DTR	CTS	DCD	DSR

- **Serial Pin Signal Data**—1 byte with each bit being set to high (1) or low (0) for the appropriate serial pin signals.

UDP Unicast Example

For an example of the I/O UDP unicast, see the sample program, `ioudpbcast.c`, found on your CD-ROM.

I/O Modbus Slave

If you have a Modbus serial or TCP application, it can access I/O connected to the IOLAN when the I/O Global Modbus Slave is enabled. You must supply a unique UID for the IOLAN, as it will act as a Modbus Slave.

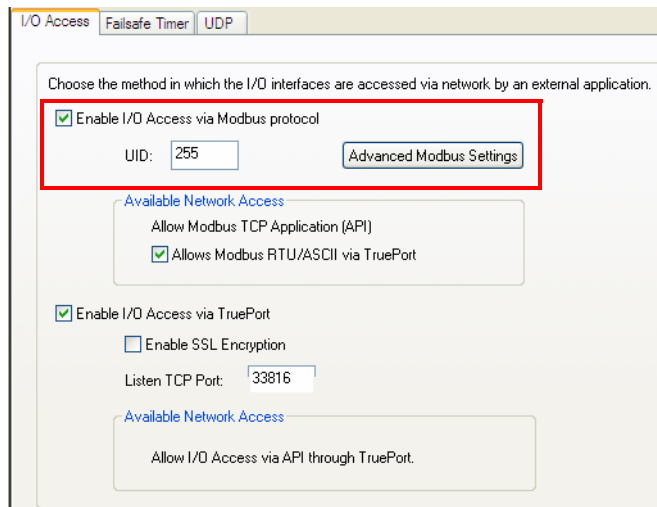

There are three ways your Modbus Application can connect to the IOLAN to access I/O.

Modbus Serial Application Connected to the Serial Port

Your Modbus serial application can be connected right to the IOLAN serial port to access I/O.

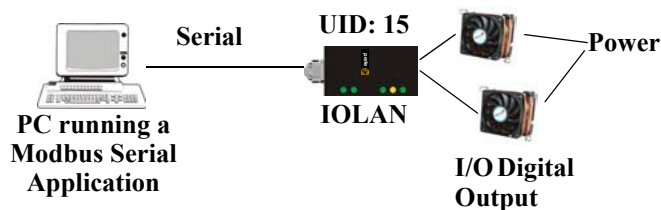

Modbus Serial Application Connected to the Network

If you want to access the I/O from a LAN connection, you can install TruePort on the PC running the Modbus serial application as described in [TruePort I/O](#) and connect to the IOLAN over the network.

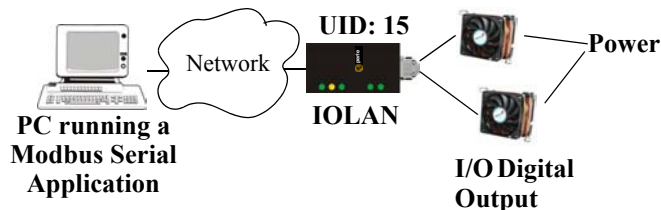

Modbus TCP Application

If you have a Modbus RTU or Modbus ASCII program, you can access the I/O by connecting to the IOLAN over the network.

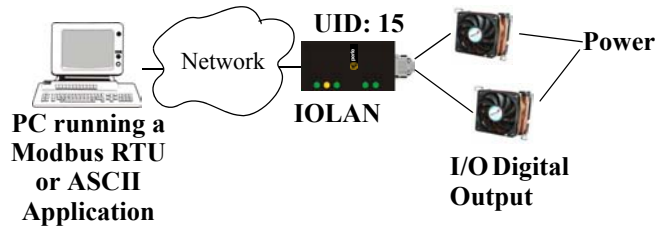

Modbus I/O Access

The section defines the function codes and registers you will need to access the I/O through Modbus TCP, Modbus serial, or Modbus serial/TruePort.

Function Codes

The following function codes are supported by the IOLAN:

- 01 read coils
- 03 read multiple holding registers
- 04 read input registers
- 05 write coil
- 06 write single register
- 08 diagnostics (echo the request)
- 15 force multiple coils
- 16 write multiple registers

There are four Modbus data models:

Discrete Input	Not used
Coils	Digital Input (DI), Alarm state for DI, Digital Output (DO). All coils are Boolean values and are 1 byte.
Input Registers (IR)	Analog Input (AI), Alarm state for AI. All Input Registers are 2 bytes long.
Holding Registers	Status (R), Control value (R/W or W). Holding Registers with <code>_ENG</code> registers are 4 bytes long, all other Holding Registers are 2 bytes long.

All coil/register values are in decimal.

I/O Coil/Register Descriptions

This section contains descriptions of I/O coils:

- **MB_REG_DI_SENSOR**—Status of Digital input. 1 is Active, 0 is Inactive. If **Invert Signal** is configured **on**, 0 is Active, 1 is Inactive. If input is **Latched**, returns latched status.
- **MB_REG_DI_SENSOR_ALARM_STATE**—Indication if input is in alarm state. 1 is In Alarm state, 0 is Not in Alarm state. A write of any value clears the alarm state.
- **MB_REG_DO_SENSOR**—Status of Digital output. 1 is Active, 0 is Inactive. If **Invert Signal** is configured **on**, 0 is Active, 1 is Inactive.

This section contains descriptions of I/O holding registers:

- **MB_REG_HR_DI_SENSOR_LATCH**—The latch status of the Digital input. 1 is Latched, 0 is Not latched. A write of any value will clear the latch.
- **MB_REG_HR_DO_SENSOR_PULSE_ISW**—Inactive Signal Width. This is how long the channel will remain inactive during pulse mode in increments of 100ms. Valid values are 1-9999. The default is 1 (100 ms).
- **MB_REG_HR_DO_SENSOR_PULSE_ASW**—Active Signal Width. This is how long the channel will be active during the pulse mode in increments of 100ms. Valid values are 1-9999. The default is 1 (100 ms).
- **MB_REG_HR_DO_SENSOR_PULSE_COUNT**—The number of times the channel output will pulse. Each count consists of an active/inactive sequence. The default is 1 cycle.
- **MB_REG_HR_AI_CLEAR_ALARM_LATCH**—Used to reset a latched alarm state. A write of any value will clear the alarm latch for the specific Analog input.
- **MB_REG_HR_AI_CLEAR_MAX**—Used to reset the Analog input maximum value reached. A write of any value will reset the maximum.
- **MB_REG_HR_AI_CLEAR_MIN**—Used to reset the Analog input minimum value reached. A write of any value will reset the minimum.

This section contains descriptions of I/O input registers:

- **MB_REG_IR_CURR_ENG**—The current value of an Analog or Temperature input converted to appropriate units. For Analog, this will be in voltage or current, depending on the configuration. For the Temperature, this value will be in Celsius or Fahrenheit, depending on configuration.
- **MB_REG_IR_MIN_ENG**—The minimum converted value ever reached on this input since the IOLAN was re-started or a manual clear was issued.
- **MB_REG_IR_MAX_ENG**—The maximum converted value ever reached on this input since the IOLAN was re-started or a manual clear was issued.
- **MB_REG_IR_CURR_RAW**—The current raw value received from the Analog to Digital converter. This is a hexadecimal value in the range of 0 -0xFFFF.
- **MB_REG_IR_MIN_RAW**—The minimum raw value ever reached on this input since the IOLAN was re-started or a manual clear was issued.
- **MB_REG_IR_MAX_RAW**—The maximum converted value ever reached on this input since the IOLAN was re-started or a manual clear was issued.
- **MB_REG_IR_ALARM_LEVEL**—This gives the current alarm severity level for the corresponding Analog input. Severity levels range from 0 (not in alarm) to 5 (highest alarm severity).

Serial Port Coil/Register Descriptions

This section contains descriptions of serial port coils:

- **MB_REG_DI_DSR**—The status of the DSR input signal. 1 is Active, 0 is Inactive. If **Invert Signal** is configured **on**, 0 is Active, 1 is Inactive. If input is **Latched**, returns latched status.
- **MB_REG_DI_DSR_ALARM_STATE**—The alarm state of DSR input signal. 1 is In Alarm state, 0 is Not in Alarm state. A write of any value clears the alarm state.
- **MB_REG_DI_DCD**—The status of DCD line. 1 is Active, 0 is Inactive. If **Invert Signal** is configured **on**, 0 is Active, 1 is Inactive.
- **MB_REG_DI_DCD_ALARM_STATE**—The alarm state of DCD input signal. 1 is in Alarm state, 0 is Not in Alarm state. A write of any value clears the alarm state.
- **MB_REG_DI_CTS**—The status of CTS input signal. 1 is Active, 0 is Inactive. If **Invert Signal** is configured **on**, 0 is Active, 1 is Inactive.
- **MB_REG_DI_CTS_ALARM_STATE**—The alarm state of CTS input signal. 1 is Alarm, 0 is Not in Alarm. A write of any value clears the alarm state.
- **MB_REG_DO_DTR**—The status of DTR output signal. 1 is Active, 0 is Inactive.
- **MB_REG_DO_RTS**—The status of RTS output signal. 1 is Active, 0 is Inactive.

This section contains descriptions of serial port holding registers:

- **MB_REG_HR_DI_DSR_LATCH**—The latched status for the DSR signal. 1 is Latched, 0 is Not Latched. A write any value will clear the latch.
- **MB_REG_HR_DI_DCD_LATCH**—The latched status for the DCD signal. 1 is Latched, 0 is Not Latched. A write any value will clear the latch.
- **MB_REG_HR_DI_CTS_LATCH**—The latched status for the CTS signal. 1 is Latched, 0 is Not Latched. A write any value will clear the latch.

A4/T4 Registers

The following registers are supported by the IOLAN A4 and T4 Input models:

	Data Model	A1/T1	A2/T2	A3/T3	A4/T4	R/W
Holding Registers:						
	MB_REG_HR_AI_CLEAR_ALARM_LATCH	2049	2050	2051	2052	W
	MB_REG_HR_AI_CLEAR_MAX	2113	2114	2115	2116	W
	MB_REG_HR_AI_CLEAR_MIN	2177	2178	2179	2180	W
Input Registers:						
	MB_REG_IR_CURR_ENG	2080	2112	2144	2176	R
	MB_REG_IR_MIN_ENG	2082	2114	2146	2178	R
	MB_REG_IR_MAX_ENG	2084	2116	2148	2180	R
	MB_REG_IR_CURR_RAW	2086	2118	2150	2182	R
	MB_REG_IR_MIN_RAW	2087	2119	2151	2183	R
	MB_REG_IR_MAX_RAW	2088	2120	2152	2184	R
	MB_REG_IR_ALARM_LEVEL	2089	2121	2153	2185	R

A4D2/A4R2 Registers

The following coils and registers are supported by the IOLAN A4D2 and A4R2 I/O models:

	Data Model	A1	A2	A3	A4	D1/R1	D2/R2	R/W
Coils:								
	MB_REG_DI_SENSOR	----	----	----	----	6149	6150	R
*	MB_REG_DI_SENSOR_ALARM_STATE	----	----	----	----	6213	6214	R/W
	MB_REG_DO_SENSOR	----	----	----	----	6661	6662	R/W
Holding Registers:								
	MB_REG_HR_DI_SENSOR_LATCH	----	----	----	----	6149	6150	R/W
	MB_REG_HR_DO_SENSOR_PULSE_ISW	----	----	----	----	6213	6214	R/W
	MB_REG_HR_DO_SENSOR_PULSE_ASW	----	----	----	----	6277	6278	R/W
	MB_REG_HR_DO_SENSOR_PULSE_COUNT	----	----	----	----	6341	6342	R/W
	MB_REG_HR_AI_CLEAR_ALARM_LATCH	2049	2050	2051	2052	----	----	W
	MB_REG_HR_AI_CLEAR_MAX	2113	2114	2115	2116	----	----	W
	MB_REG_HR_AI_CLEAR_MIN	2177	2178	2179	2180	----	----	W
Input Registers:								
	MB_REG_IR_CURR_ENG	2080	2112	2144	2176	----	----	R
	MB_REG_IR_MIN_ENG	2082	2114	2146	2178	----	----	R
	MB_REG_IR_MAX_ENG	2084	2116	2148	2180	----	----	R
	MB_REG_IR_CURR_RAW	2086	2118	2150	2182	----	----	R
	MB_REG_IR_MIN_RAW	2087	2119	2151	2183	----	----	R
	MB_REG_IR_MAX_RAW	2088	2120	2152	2184	----	----	R
	MB_REG_IR_ALARM_LEVEL	2089	2121	2153	2185	----	----	R

*For DI alarm state, read will get state, write will clear alarm.

D4/D2R2 Registers

The following coils and registers are supported by the IOLAN D4 and D2R2 I/O models:

	Data Model	D1	D2	D3/R1	D4/R2	R/W
Coils:						
	MB_REG_DI_SENSOR	6145	6146	6147	6148	R
*	MB_REG_DI_SENSOR_ALARM_STATE	6209	6210	6211	6212	R/W
	MB_REG_DO_SENSOR	6657	6658	6659	6660	R/W
Holding Registers:						
	MB_REG_HR_DI_SENSOR_LATCH	6145	6146	6147	6148	R/W
	MB_REG_HR_DO_SENSOR_PULSE_ISW	6209	6210	6211	6212	R/W
	MB_REG_HR_DO_SENSOR_PULSE_ASW	6273	6274	6275	6276	R/W
	MB_REG_HR_DO_SENSOR_PULSE_COUNT	6337	6338	6339	6340	R/W

*For DI alarm state, read will get state, write will clear alarm.

Serial Pin Signals

The following coils and registers are supported by the IOLAN I/O models:

	Data Model	Pin	R/W
Coils:			
	MB_REG_DI_DSR	4225	R
	MB_REG_DI_DSR_ALARM_STATE	4289	R/W
	MB_REG_DI_DCD	4353	R
	MB_REG_DI_DCD_ALARM_STATE	4417	R/W
	MB_REG_DI_CTS	4481	R
	MB_REG_DI_CTS_ALARM_STATE	4545	R/W
	MB_REG_DO_DTR	4673	R/W
	MB_REG_DO_RTS	4737	R/W
Holding Registers:			
	MB_REG_HR_DI_DSR_LATCH	4097	R/W
	MB_REG_HR_DI_DCD_LATCH	4609	R/W
	MB_REG_HR_DI_CTS_LATCH	5121	R/W

TruePort I/O

You can see a sample API I/O over TruePort program called `ioapiotpc` on the CD-ROM.

TruePort/Modbus Combination

If you have a Modbus serial application running on a PC that is connected to a network, you can use TruePort as a virtual serial connection to communicate with the IOLAN over the network to access I/O data.

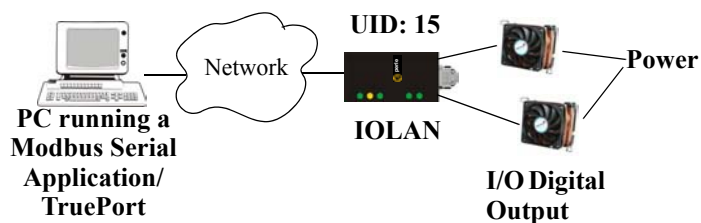
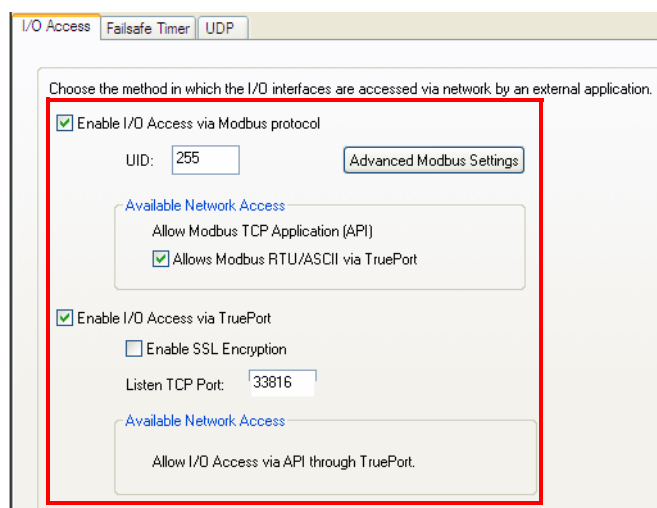

The host running TruePort must be in Modbus/ASCII or Modbus/RTU mode.

API Over TruePort Only

If you have a custom application that talks to a serial port, you can use TruePort as a virtual serial port to communicate with the IOLAN over the network to access I/O data using the Perle API. See [Accessing I/O Data Via TruePort](#) for more information on the API.)

I/O Access | Failsafe Timer | UDP

Choose the method in which the I/O interfaces are accessed via network by an external application.

Enable I/O Access via Modbus protocol

UID:

Available Network Access

Allow Modbus TCP Application (API)

Allows Modbus RTU/ASCII via TruePort

Enable I/O Access via TruePort

Enable SSL Encryption

Listen TCP Port:

Available Network Access

Allow I/O Access via API through TruePort.

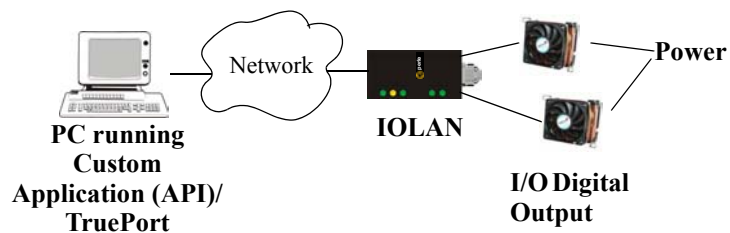

The host running TruePort must be in I/O API mode.

Accessing I/O Data Via TruePort

Introduction

Analog and Digital I/O data, as well as output control, can be accessed in several ways. To have access from an application running on a workstation or server, the I/O Applications Program Interface (API) provided within Trueport can be used. This API uses a command/response format to get or set data on each individual I/O channel register. A sample program (`ioapiotp.c`) demonstrating typical usage can be found on the IOLAN product CD-ROM.

Setup

After TruePort has been properly installed and configured on the workstation or server and initiated from the application, it will setup a connection to the appropriate IOLAN. It will then be available to relay commands to the IOLAN and communicate responses back the application. TruePort will create a COM port to which the application can write commands to and read responses from. Since all communications are done via this COM port, the application need only use standard serial communication interface calls.

The following steps should be taken:

1. Install the Trueport software on the server or workstation on which the application will be running.
2. Configure the virtual communication port (COM) (see *TruePort User Guide* for details)
3. Run the application. Typically the application will:
 1. Open the COM port.
 2. Send Commands to the COM port using standard write commands.
 3. Read Responses from the COM port using standard read commands.

Note: All commands are forwarded to the IOLAN over the network where the specific I/O channel registers are modified or read, and then responses are sent back to TruePort where they will be made available to be read from the COM port.

4. Once the desired operations are completed, the COM port can be closed.

Format of API Commands

There are two groups of commands:

- **Get Commands**—Retrieve values of the I/O channel registers
- **Set Commands**—Set values on the I/O channel registers.

Note: All commands need to be written to the COM port as a single write.

I/O Channel registers are all assigned unique addresses, which need to be referenced in all of the commands. Please refer to the documentation specific you the applicable mode, for the list and addresses of all the registers.

Model	Go to...
A4	<i>A4/T4 Registers</i>
T4	<i>A4/T4 Registers</i>
A4D2	<i>A4D2/A4R2 Registers</i>
A4R2	<i>A4D2/A4R2 Registers</i>
D4	<i>D4/D2R2 Registers</i>
D2/R2	<i>D4/D2R2 Registers</i>

Get Commands

The following tables show the general structure to be used for Get commands.

Note: Numeric values provided in the API documentation are in Hexadecimal (Hex) format.

Command Format

Byte(s)	# of Bytes	Value
1	1	Command Code: <ul style="list-style-type: none"> ● 0x01 – Get “coils” (Boolean register) ● 0x03 – Get “holding registers” (R/W registers) ● 0x04 – Get “input registers” (R only register)
2-3	2	Starting register number (see <i>A4/T4 Registers</i> , <i>A4D2/A4R2 Registers</i> , or <i>D4/D2R2 Registers</i> for this value).
4-5	2	Number of registers to read. If this value is greater than 1, the response will contain the values of multiple consecutive registers.

Response Format

Byte(s)	# of Bytes	Value
1	1	Command that this is a response to. If an error has been detected, the command value will have the high bit set (OR with 0x80). For example: The command is 0x04, so the command field in the response would be 0x84.
2	1	Length of data (in bytes) starting in next byte.
3-n	n	Requested register values.

Example 1: Read the status of the first digital input (DI1) on a D2R2 unit.

DI1 sensor is a coil register with the decimal value of 6145 (hex 0x1801).

Request: 0x01 0x18 0x01 0x00 0x01

Response: 0x01 0x01 0x01 (Digital input 1 is active)

Example 2: Read the values for the Inactive Signal Width, Active Signal Width, and Pulse count for the second digital output (DO2) on a D4 unit.

DO2, Inactive Signal Width is a holding register with the decimal value of 6210 (hex 0x1842).

Request: 0x03 0x18 0x42 0x00 0x03

Response: 0x03 0x06 0x00 0x0A 0x00 0x11 0x00 0x0F
(Inactive = 10*100ms, Active = 17*100ms, and Pulse count = 15)

Example 3: Read the raw current, minimum and maximum values of the third Analog input (A3) on an A4D2 unit.

A3 current raw value is an input register with the decimal value of 2150 (hex 0x0866).

Request: 0x04 0x08 0x86 0x00 0x03

Response: 0x04 0x06 0x10 0x03 0x0F 0x30 0x10 0x20
(Current = 0x1003, Minimum = 0x0F30, and Maximum = 0x1020)

Set Commands

The following tables show the general structure to be used for set commands.

Note: Numeric values provided in the API documentation are in Hexadecimal (Hex) format.

Command Format

Byte(s)	# of Bytes	Value
1	1	Command Code (in hex): <ul style="list-style-type: none"> ● 0x0F – Set “Boolean registers” (R/W coils) ● 0x10 – Set “holding registers” (read/write registers)
2-3	2	Starting register number (see <i>A4/T4 Registers</i> , <i>A4D2/A4R2 Registers</i> , or <i>D4/D2R2 Registers</i> for this value).
4-5	2	Number of registers to set. If this value is greater than 1, the response will contain the values of multiple consecutive registers.
6	1	The length of the data (in bytes) to be written to the registers.
7-n	n	Data to be written to the registers. If accessing registers which are 2 or 4 bytes, the data is in Network order (Big endian) format (that is, MSB, LSB). For Boolean registers, the value field will be a bit field with the LSBit corresponding to the IO channel referenced by the starting register.

Successful Response Format

Byte(s)	# of Bytes	Value
1	1	Command code (from request).
2	2	Starting register number (see <i>A4/T4 Registers</i> , <i>A4D2/A4R2 Registers</i> , or <i>D4/D2R2 Registers</i> for this value) from request.
4	2	Number of registers written.

Unsuccessful Response Format

Byte(s)	# of Bytes	Value
1	1	Command that this is a response to. If an error has been detected, the command value will have the high bit set (OR with 0x80). For example: The Command is 0x10, so the command field in the response would be 0x90.
1	1	Error code, see <i>Error Codes</i> .

Example 1: Turn on the first relay on a D2R2 unit.

The first relay (R1) is a digital out coil register with a decimal value of 6659 (hex 0x1A03).

Request: 0x0F 0x1A 0x03 0x00 0x01 0x01 0x01

Response: 0x0F 0x1A 0x03 0x00 0x01

Example 2: Turn on the first and second relay on a D2R2 unit.

The first relay (R1) is a digital out coil register with a decimal value of 6659 (hex 0x1A03).

Request: 0x0F 0x1A 0x03 0x00 0x02 0x01 0x03 (03 = “00000011” which sets R1 and R2 to 1)

Response: 0x0F 0x1A 0x03 0x00 0x02

Note: When reading or writing consecutive “Boolean” (coils) registers, the values of the registers are combined into a single byte as shown by the example above. Two registers (coils) are being written but the length of the data is 1 byte. The one byte contains the value for both registers as follows:

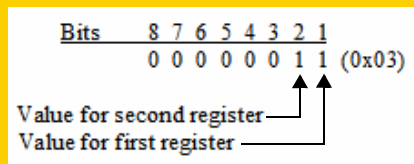

Error Codes

Code	Name	Description
01	Illegal Function	The function code received in the query is not an allowable action for the server (or slave).
02	Illegal Data Address	The data address received in the query is not an allowable address for the server (or slave).
03	Illegal Data Value	A value contained in the query data field is not an allowable value for server (or slave).
04	Slave Device Failure	An unrecoverable error occurred while the server (or slave) was attempting to perform the requested action.

I/O SNMP Traps

When you enable SNMP traps for Digital and Analog inputs, a value is returned when an alarm triggers or clears. This section decodes the SNMP specific trap numbers. The value returned from the trap will be the I/O channel number that is generating the trap.

Specific Trap #	Alarm	Description
0	IO_DI_ALARM_SENSOR	Trap for the Digital input Trigger.
1	IO_DI_ALARM_SERIAL_DSR	Trap for the Digital input DSR serial pin Trigger.
2	IO_DI_ALARM_SERIAL_DCD	Trap for the Digital input DCD serial pin Trigger.
3	IO_DI_ALARM_SERIAL_CTS	Trap for the Digital input CTS serial pin Trigger.
4	IO_AI_ALARM_LEVEL1	Trap for Analog input Alarm Level 1.
5	IO_AI_ALARM_LEVEL2	Trap for Analog input Alarm Level 2.
6	IO_AI_ALARM_LEVEL3	Trap for Analog input Alarm Level 3.
7	IO_AI_ALARM_LEVEL4	Trap for Analog input Alarm Level 4.
8	IO_AI_ALARM_LEVEL5	Trap for Analog input Alarm Level 5.
9	IO_DI_ALARM_SENSOR_CLEAR	Trap for Digital input trigger Clear Mode.
10	IO_DI_ALARM_SERIAL_DSR_CLEAR	Trap for Digital input DSR serial pin trigger Clear Mode.
11	IO_DI_ALARM_SERIAL_DCD_CLEAR	Trap for Digital input DCD serial pin trigger Clear Mode.
12	IO_DI_ALARM_SERIAL_CTS_CLEAR	Trap for Digital input CTS serial pin trigger Clear Mode.
13	IO_AI_ALARM_LEVEL1_CLEAR	Trap for the Analog input Alarm Level 1 Clear.
14	IO_AI_ALARM_LEVEL2_CLEAR	Trap for the Analog input Alarm Level 2 Clear.
15	IO_AI_ALARM_LEVEL3_CLEAR	Trap for the Analog input Alarm Level 3 Clear.
16	IO_AI_ALARM_LEVEL4_CLEAR	Trap for the Analog input Alarm Level 4 Clear.
17	IO_AI_ALARM_LEVEL5_CLEAR	Trap for the Analog input Alarm Level 5 Clear.

11

Configuring the System

Introduction

This chapter describes the alerts (syslog) that can be configured for the IOLAN and the advanced options (SNMP, custom applications/plugins, and other miscellaneous configuration options) that you will want to look at to see if they are required for your implementation.

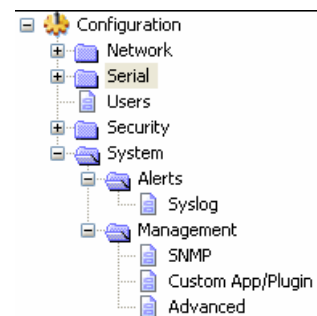

Alerts

Syslog

Overview

The IOLAN can be configured to send system log messages to a syslog daemon running on a remote host if the **Syslog** service is activated. You can configure a primary and secondary host for the syslog information and specify the level for which you want syslog information sent.

Note: You must ensure that the **Syslog Client** service in the **Security, Services** window is enabled (by default it is enabled) for these settings to work.

Field Descriptions

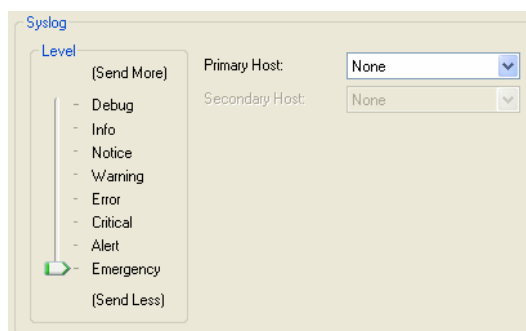

Configure the following parameters:

- Primary Host** The first preconfigured host that the IOLAN will attempt to send system log messages to; messages will be displayed on the host's monitor.
Default: None

Secondary Host If the IOLAN cannot communicate with the primary host, then the IOLAN will attempt to send system log messages to this preconfigured host; messages will be displayed on the host's monitor.

Default: None

Level Choose the event level that triggers a syslog entry.

Data Options: Emergency, Alert, Critical, Error, Warning, Notice, Info, Debug

Default: Emergency

Management

SNMP

Overview

If you are using SNMP to manage/configure the IOLAN, or to view statistics or traps, you must set up a User in SNMP version 3 or a Community in SNMP version 1,2 to allow your SNMP manager to connect to the IOLAN; this can be done in the DeviceManager, WebManager, CLI, or Menu. You must then load the `perle-ds.MIB` (found on the CD-ROM packaged with the IOLAN) file into your SNMP manager before you connect to the IOLAN.

Note: Ensure that the **SNMP** service found in the **Security, Services** page is enabled (by default it is enabled).

Field Descriptions

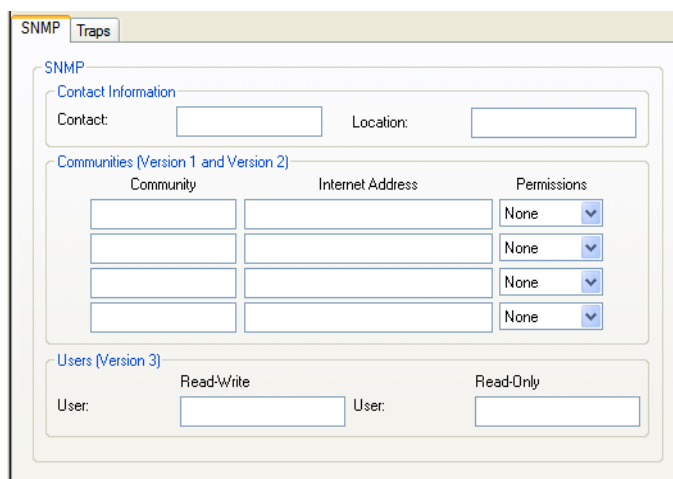

The screenshot shows the SNMP configuration page with the following sections:

- Contact Information:** Fields for Contact and Location.
- Communities (Version 1 and Version 2):** A table with columns for Community, Internet Address, and Permissions. The Permissions column has a dropdown menu set to 'None'.
- Users (Version 3):** Fields for Read-Write and Read-Only users.

Configure the following parameters:

Contact The name and contract information of the person who manages this SMNP node.

Location The physical location of the SNMP node.

Community The name of the group that devices and management stations running SNMP belong to. Community only applies to SNMP v1 and v2c.

Internet Address The IP address of the SNMP manager that will send requests to the IOLAN. If the address is 0.0.0.0, any SNMP manager with the **Community** name can access the IOLAN. If you specify a network address, for example 172.16.0.0, any SNMP manager within the local network with the **Community** name can access the IOLAN.

Field Format: IPv4 or IPv6 address

Permissions Permits the IOLAN to respond to SNMP requests.

Data Options:

- **None**—There is no response to requests from SNMP.
- **Readonly**—Responds only to Read requests from SNMP.
- **Readwrite**—Responds to both Read and Write requests from SNMP.

Default: None

Read-Write User Specified user can view and edit SNMP variables.

Read-Only User Specified user can only view SNMP variables.

SNMP Traps Tab Field Descriptions

The screenshot shows the 'SNMP Traps' configuration page. At the top, there are two tabs: 'SNMP' and 'Traps', with 'Traps' being the active tab. Below the tabs, the page is titled 'SNMP Traps'. There are two sub-sections: 'Traps' and 'Inform'. The 'Traps' section contains a table with four columns: 'Internet Address', 'Version', 'Type', and 'Community (V1 or V2c)'. There are four rows, each with a checkbox, a text input field containing '0.0.0.0', a dropdown menu with 'v1', a dropdown menu with 'Trap', and a text input field. The 'Inform' section contains two fields: 'Timeout' with a value of '1' and 'Retries' with a value of '3'. Below the 'Inform' section is the 'Engine ID (Version 3)' section, which has a text input field for 'Engine ID' containing 'Not Available', a radio button selected for 'Use Default Engine ID', and a radio button for 'Create Engine ID Using String' with an associated text input field.

Configure the following parameters:

Trap checkbox Check this box to enable the entry of the trap information.

Internet Address The IP address of the SNMP manager(s) that will receive trap messages from the IOLAN.

Field Format: IPv4 or IPv6 address

Version Select the version of trap you want the IOLAN to send.

Type Select between Trap or Inform. Inform requires receiving host to acknowledge receipt of the trap.

Community	The name of the group that devices and management stations running SNMP belong to. Community only applies to SNMP v1 and v2c.
Inform Timeout	This is only used for Inform traps. Select the number of seconds to wait for the acknowledgement of the trap. T Default: 1 second.
Retires	This is only used for Inform traps. Select the number of times the trap will be sent if no acknowledgement is received. Default: 3
V3 Trap User	This field identifies the system sending the traps to the host receiving the traps. Same user name is used for all traps sent by this system.
V3 EngineID	This is the current Engine ID. The Engine ID is a string which uniquely identifies this SNMP agent.
V3 Use Default EngineID	When this field is selected, the firmware will use the default Engine ID. The default Engine ID uses the MAC address of the Ethernet interface to ensure that the Engine ID is unique to this agent.
V3 Create EngineID Using String	The string entered in this field will be combined with the defined string in hex of 800007AE04 to form the EngineID. Ensure each string is unique for each IOLAN on your network.

Custom App/Plugin

Overview

You can create custom applications for the IOLAN by using the Perle SDK. See the *SDK Programmer's Guide* (the SDK and guide are accessible via a request form located on the Perle website at www.perle.com/supportfiles/SDK_Request.shtml) for information about the functions that are supported. You must download the program and any ancillary files to the IOLAN and set the **Serial Port Profile** to **Custom App/Plugin** to run a custom application. You must also specify the program executable in the **Command Line** parameter.

A custom application or plugin can be run on the serial port. In this situation, the application will start once the serial port is activated and operate solely on the context of that serial port and any network communications related to that serial port. You could run a different custom application on each serial port. The serial port custom application or plugin is configured by specifying the **Custom App/Plugin** profile for the serial port.

The system level custom application or plugin will begin execution immediately following the system startup. It runs on the context of the whole system and can access network communications as well as any or all serial ports.

Field Description

Custom Application/Plugin Settings

To install a custom application:

- 1) Download the application files to the IOLAN using Tools->Advanced->Custom Files->Download Custom App/Plugin.
- 2) Specify the command line below.

Command Line:

- 3) Reboot the IOLAN.

Configure the following parameter:

Command Line The name of the application that has been already been downloaded to the IOLAN, plus any parameters you want to pass to the program. For example, using sample **outraw** program (this is sample program supplied with the SDK), you would type:

```
outraw -s 0 192.168.2.1:10001 Acct:10001
```

if you were starting the application on the Server (notice the **-s 0** parameter specifies serial port 1 to this particular application).

Field Format: Maximum of 80 characters

Advanced

Overview

Review the configuration options in the Advanced page to determine if any of them apply to your implementation.

Login Tab Field Descriptions



Configure the following parameters:

Use System Name in Prompts Displays the **System Name** field value instead of default product name. When enabled, the **Server Name** is displayed in the IOLAN login prompt, CLI prompt, WebManager login screen, and the heading of the Menu.
Default: Disabled

Display Login Banner This parameter concerns the banner information (product name/software version). This banner information is presented to a user with a login prompt. For security reasons, you can turn off the display of this information.
Default: Disabled

Use Custom Login Prompt When set, and a custom language file is in use, the login prompt and password prompt will use the string defined in the language file as the login prompt and password prompt instead of the default prompt,
login:.
password:
Default: Disabled

Bypass Login Password When set, authorized users who do not have a password set, with the exception of the admin user, WILL NOT be prompted for a password at login with **Local Authentication**.
Default: Disabled

- Use a Generic WebManager Login Screen** When set, and the user connects to the IOLAN using WebManager, the WebManager login screen that is displayed is generic — the Perle banner, IOLAN model name, and firmware version are not displayed to the user.
Default: Disabled
- Password Retry Limit** The number of attempts a user is allowed to enter a password for a serial port connection from the network, before the connection is terminated and the user has to attempt to login again. For users logging into the serial port, if this limit is exceeded, the serial port is disabled for 5 minutes. A user with Admin level rights can restart the serial port, bypassing the timeout, by issuing a kill on the disabled serial port.
Default: 3
- EasyPort Web** Select Java if communication is via port 23(Telnet) or port 22(SSH) and communication is not restricted by a firewall.
Select Javascript if you need to communicate through a firewall on port 8080 using Easyport.
To end and close a Telnet session, type CTRL] then quit.
To end or close a SSH session, type ~. (period).

Bootup Files Tab Field Descriptions

You must have a TFTP server running on any host that you are uploading or downloading files to/from. When you specify the file path, the path must be relative to the default path set in your TFTP server software.

The screenshot shows a web browser window with several tabs: 'Login', 'Bootup Files', 'Message of the Day (MOTD)', and 'TFTP'. The 'Bootup Files' tab is selected. It contains two sections: 'Firmware' and 'Configuration'. Each section has a 'Host' label and a 'File' label, each followed by an empty text input field.

Configure the following parameters:

- Firmware Host** The host name or IP address of the server that contains the firmware file. If you use a host name, it must exist in the IOLAN's host table or be resolved by DNS.
Field Format: Resolvable host name, IPv4 address, IPv6 address
- Firmware File** The path and file name, relative to the default path of your TFTP server software, of the update software for the IOLAN that will be loaded when the IOLAN is rebooted.
- Configuration Host** The host name or IP address of the server that contains the configuration file. If you use a host name, it must exist in the IOLAN's host table or be resolved by DNS.
Field Format: Resolvable host name, IPv4 address, IPv6 address
- Configuration File** The path and file name, relative to the default path of your TFTP server software, of the configuration file for the IOLAN that will be loaded when the IOLAN is rebooted.

Message of the Day (MOTD) Tab Field Descriptions

The message of the day is displayed when users log into the IOLAN through a telnet or SSH session or through WebManager or EasyPort Web.

There are two ways to retrieve the message of the day to be displayed to users when they log into the IOLAN:

- The message of the day file is retrieved from a TFTP server every time a user logs into the IOLAN. You must have a TFTP server running on any host that you are uploading or downloading files to/from when using TFTP. When you specify the file path, the path must be relative to the default path set in your TFTP server software.
- The message of the day file is downloaded to the IOLAN and retrieved locally every time a user logs into the IOLAN. You can download an MOTD file to the IOLAN in the DeviceManager by selecting **Tools, Advanced, Custom Files** and then selecting the **Download Other File** option and browse to the MOTD file. In WebManager, select **Administration, Custom Files** and select the **Other File** option and browse to the MOTD file. After the MOTD is downloaded to the IOLAN, you must specify the MOTD file name in the **Filename** field to access it as the message of the day (no **TFTP Host** parameter is required when the file is internal).

Configure the following parameters:

TFTP Host	The host that the IOLAN will be getting the Message of the Day file from. Field Format: Resolvable host name, IPv4 address, IPv6 address
Filename	The path and file name, relative to the default path of your TFTP server software, of the file that contains a string that is displayed when a user connects to the IOLAN. The IOLAN will look for the file internally (it must already be downloaded), if only the file is specified (no TFTP host) or the file cannot be found on the specified TFTP host.
Display MOTD in WebManager	When enabled, displays the Message of the Day to users who are logging into WebManager. Default: Disabled

TFTP Tab Field Descriptions

You must have a TFTP server running on any host that you are uploading or downloading files to/from.

Note: TFTP file transfers send via UDP packets. When the packet delivery is interrupted for any reason and a timeout occurs, that packet is resent if the retry count allows it. Therefore, if a very large file is being transferred and is interrupted, the entire file is not resent, just the part of the file that was not received.

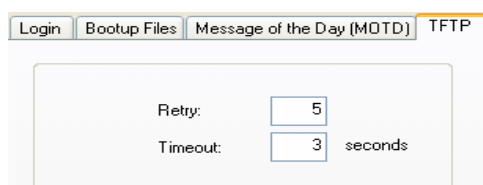

The screenshot shows a web interface with a navigation bar containing tabs for 'Login', 'Bootup Files', 'Message of the Day (MOTD)', and 'TFTP'. The 'TFTP' tab is selected. Below the navigation bar is a configuration area with two input fields: 'Retry' with a value of '5' and 'Timeout' with a value of '3' followed by the text 'seconds'.

Configure the following parameters:

- Retry** The number of times the IOLAN will retry to transmit a TPFT packet to/from a host when no response is received. A value of **0** (zero) means that the IOLAN will not attempt a retry should TFTP fail.
Range: 0-5
Default: 5
- Timeout** The time, in seconds, that the IOLAN will wait for a successful transmit or receipt of TFTP packets before retrying a TFTP transfer.
Range: 3-10
Default: 3 seconds

12

Controlling the I/O Channels

Introduction

The Control section appears when the IOLAN is connected to an I/O model.

I/O Channels

Overview

When the DeviceManager is connected to an I/O model IOLAN, the I/O Status/Control option is available. You can view the I/O status and manually control such options as clearing alarms, clearing minimum/maximum values, resetting the channel(s), and activating/deactivating output.

Channel	Type	Description	Value	Minimum	Maximum	Latched Value	Alarm
A1	Input	thermocouple	99.79	89.38	242.43		Level 1
A2	Input		Open	-59.38	305.25		Level 0
A3	Input		Open	-59.38	305.25		Level 0
A4	Input		Open	-59.38	305.25		Level 0

I/O Channel Control

Reset Channel Clear Alarm Clear Minimum Value Activate Output Reset All Channels

Clear Latched Input Clear Maximum Value Deactivate Output

Refresh

The following buttons are available:

- Reset Channel Button** Resets the highlighted channel (click on a channel to highlight it).
- Clear Alarm Button** Clears the alarm. Note that if the condition that tripped the alarm still exists, the alarm will not look like it's cleared, but will reflect the appropriate alarm level severity. Alarm Level 0 means that the alarm has not been triggered.
- Clear Latched Input Button** Clears the latched value.
- Clear Minimum Value Button** Clears the minimum value.
- Clear Maximum Value Button** Clears the maximum value.

Activate Output Button Manually activates the channel output.

Deactivate Output Button Manually deactivates the channel output.

Reset All Channels Button Resets all the channels.

Refresh Button Resets the highlighted channel (click on a channel to highlight it).



System Administration

Introduction

This chapter addresses the functions that the admin user or a user with Admin Level privileges might do. This chapter uses the DeviceManager as the configuration method described in most administrative functions. As a general rule, administrative functions are accessed from the menu bar in the DeviceManager and under the **Administration** option in the WebManager's navigation tree.

Managing Configuration Files

Saving Configuration Files

When you connect to the IOLAN using either DeviceManager or WebManager, the IOLAN's active configuration file is loaded into the configurator. To save a backup of the configuration file locally, do the following:

- In DeviceManager:
 1. From the menu bar, select **File, Save As**.
 2. In the Save As dialog box, specify a name and format for the file. Notice that you can save the file as either a **.dme** or a **.txt** file. Either file format can be imported into the DeviceManager and downloaded to the IOLAN in the future. The **.dme** is a binary file and the **.txt** file is a text file that can be viewed in any text editor.
 3. Click **Save**.
- In WebManager:
 1. In the navigation tree, select the **Administration** option.
 2. In the configuration area, click the **Backup/Restore** button.
 3. In the Backup group box, select the format (**Binary** or **Text**) in which you want to save the file. Either file format can be imported into the DeviceManager and downloaded to the IOLAN in the future.
 4. Click the **Backup Configuration** button.

Downloading Configuration Files

You can download a configuration file to the IOLAN by doing the following:

- In DeviceManager:
 1. Connect to the IOLAN to retrieve the current configuration file.
 2. Open the configuration file you want to download to the IOLAN by selecting **File, Import Configuration from a File** and then browsing to the configuration file. This will replace the retrieved configuration file.
 3. Select **Tools, Download Configuration to IOLAN** or click the **Download All Changes** button.
 4. Reboot the IOLAN.
- In WebManager:
 1. In the navigation tree, select the **Administration** option.
 2. In the configuration area, click the **Backup/Restore** button.
 3. In the Restore group box, browse to the configuration file that you want to download to the IOLAN.
 4. Click the **Restore Configuration** button.
 5. Reboot the IOLAN.

Downloading Configuration Files to Multiple IOLANs

You can download a configuration file to multiple IOLANs at the same time by doing the following in DeviceManager (DeviceManager is the only configurator that does this function):

1. Select **Tools, Download Configuration to Multiple IOLANs**.
2. Specify the IOLANs that you want to download the configuration to:

Enter the following information for each IOLAN that you want to configure with the same configuration file:

- | | |
|----------------------|---|
| IP Address | Enter the IP address of the IOLAN that you want to download the configuration to.
Field Format: IPv4 or IPv6 address |
| Server Name | The name of the IOLAN. The IOLAN name that you put in this field is passed into the configuration before it is downloaded to the IOLAN and cannot be left blank. |
| Password | Enter the admin user password for the IOLAN. |
| Reboot Server | Determines whether or not the IOLAN is rebooted after it has received the new configuration. The new configuration definitions will not go into effect until the IOLAN is rebooted. |

3. Click **Add** to add the IOLAN to the download list. You can also click on the IOLAN entry and edit any information and then click **Update** to make the edits permanent.

- Click the **Download>** button to start the download process. A status window will display with the configuration download status.

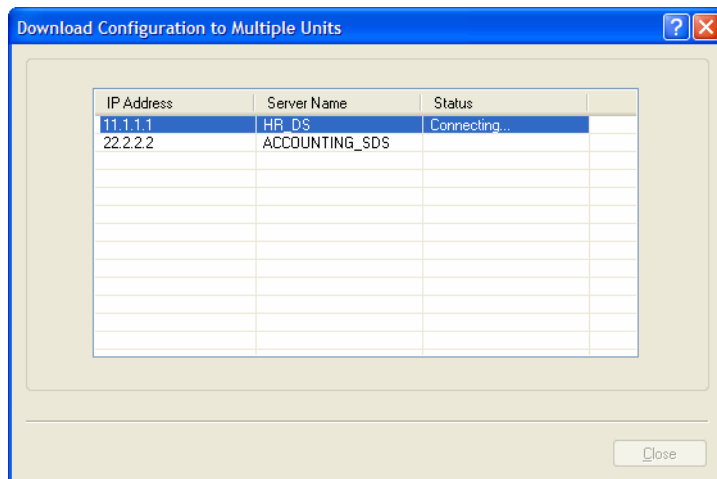

Uploading Configuration Files

When you upload a configuration to the DeviceManager, you are uploading the IOLAN's working configuration file. In most other configurators (the exception being SNMP), you are always seeing the working configuration file.

In DeviceManager, select **Tools, Upload Configuration from IOLAN**. The working configuration file will automatically be loaded into the DeviceManager.

Specifying a Custom Factory Default Configuration

When you receive the IOLAN, it comes with a factory default configuration that the IOLAN can be reset to at any time. Administrators might find it useful to customize the factory default configuration file, so that if the IOLAN gets reset to its factory defaults, it will be reset to defaults that the Administrator specified.

There are two ways you can set the custom factory default configuration:

- **Download a file to the IOLAN**—You can download a custom factory default file to the IOLAN using any of the configuration methods. In DeviceManager, you must connect to the IOLAN and then select **Tools, Advanced, Custom Files, Custom Factory Default Configuration** and then specify the file. In WebManager, you must connect to the IOLAN and then select **Administration, Reset, Factory Defaults, Set Current Configuration as Factory Default**.
- **Download the current configuration to the IOLAN**—You can specify the configuration that you are working with/on as the custom factory default configuration using any of the configuration methods (you must be connected to the IOLAN). In DeviceManager, select **Tools, Advanced, Set Factory Default to IOLAN**. In WebManager, select **Administration, Reset, Factory Defaults, Get and Set Factory Default Configuration File**.

Resetting the IOLAN to the Default Configuration

The RESET button on the IOLAN allows you to reset the IOLAN to its Perle or custom factory default configuration. The Power/Ready LED color and the resetting of the IOLAN default configuration vary depending on how long you press and hold the RESET button, as shown in the table below.

When you press and hold the RESET button for...	LED color	IOLAN system status
Less than 3 seconds	Blinking amber	Reboots
Between 3 and 10 seconds	Blinking amber, then turns solid amber when you release the RESET button	Reboots and resets the configuration to the factory default (either the Perle or custom default configuration)
Over 10 seconds	Blinking amber, then turns solid amber when you release the RESET button	Reboots and resets the configuration to the Perle factory default configuration

Downloading IOLAN Firmware

To upgrade the IOLAN firmware (software):

- In DeviceManager, select **Tools, Advanced, Download Firmware to IOLAN**. You can browse to the firmware location. Once the firmware download is complete, you will be prompted to reboot the IOLAN. You can choose to reboot the IOLAN at another time by selecting **Tools, Reset, Reboot IOLAN**.
- In WebManager, under the **Administration** option, select **Update Firmware**. Either browse to the firmware file and then click the **Upload** button or configure the TFTP server and click the **Upload** button. Note: If you use the TFTP option, the specified TFTP server must be on the same subnet as the IOLAN.

Upgrading the firmware does not affect the IOLAN's configuration file or downloaded custom files.

Calibrating I/O

All I/O channels are factory calibrated and should not need recalibration during initial use. However should calibration be required, you can recalibrate in DeviceManager or WebManager. In DeviceManager, you calibrate the I/O channel(s) by selecting **Tools, I/O Channels, Calibrate**. In WebManager, you calibrate the I/O channel(s) by selecting **I/O Channels, Calibrate**.

Calibrating Analog Input

To calibrate an Analog input channel, read the section that applies to the type of input you are calibrating. Note that calibration will be done for the active channel configuration; for example, if Channel A1 is set to voltage, you cannot calibrate it for current. The voltage range configured for this channel will also dictate what is being calibrated. For example, if this channel is configured for a range of +/-10V, calibrating this channel will calibrate all channels which are configured for +/-10V. During the calibration process, you will be asked to apply the minimum and maximum configured range value to the channel; for example, to calibrate for voltage +/- 10V, you will be prompted to first apply -10V and then +10V to the channel.

Also, you cannot actively calibrate disabled channels (although, for Voltage, if you enable the channel and then set it for a range that has already been calibrated for another channel, it will also be calibrated).

Calibrating Voltage

When calibrating the IOLAN Analog input for voltage, you will need a calibration meter that is better than .1% volts precision. When you calibrate one channel, all voltage channels are automatically calibrated for that range; if another channel is set for a different range, you will need to calibrate that channel separately, but all channels that use that range are also automatically calibrated.

Calibrating Current

When calibrating the IOLAN Analog input for current, you will need a calibration meter that is better than .1% current precision. Each channel needs to be calibrated individually.

Calibrating Temperature Input

To calibrate an Analog (Temperature) input channel, read the section that applies to the type of input you are calibrating. Note that calibration will be done for the active channel configuration; for example, if Channel A1 is set to thermocouple, you cannot calibrate it for RTD. During the calibration process, you will be asked to apply the minimum and maximum range value to the channel in either mV or Ohms; for example, to calibrate for thermocouple J 0 to 760C, you will be prompted to first apply -80mV and then +80mV to the channel.

Also, you cannot actively calibrate disabled channels (although if you enable the channel and then set it for the type of thermocouple or RTD that has already been calibrated on another channel, it will also be calibrated).

Calibrating Thermocouple

When calibrating the IOLAN Analog input for thermocouple, you will need a calibration meter that is better than .15% accuracy. When you calibrate one channel, all thermocouple channels are automatically calibrated for that range; if another channel is set for a different range, you will need to calibrate that channel separately, but all channels that use that range are automatically calibrated.

Calibrating RTD

When calibrating the IOLAN Analog input for RTD, you will need a resistor that is better than .05% Ohms accuracy. When you calibrate one channel, all RTD channels are automatically calibrated for that range; if another channel is set for a different range, you will need to calibrate that channel separately, but all channels that use that range are automatically calibrated.

Calibrating Analog Channels

Analog Input can be calibrated for Analog and Temperature IOLAN models.

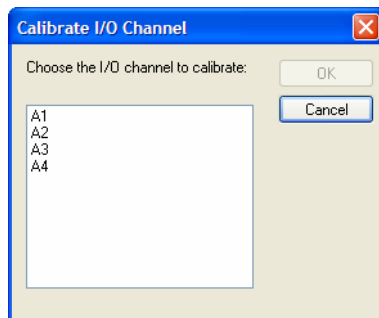

Select the channel you want to calibrate. This example uses an A4 model that has channel A1 set to Current with a Range of 0 to 20mA.

If you have not disabled confirmation messages (**Tools, Options** in DeviceManager only), you will get prompted to verify channel calibration.

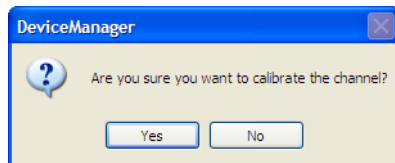

Click **Yes** to proceed with calibration. You are now prompted to apply 0 mA to the positive (+) and negative (-) terminals. Once that is done, click **Yes** to proceed.

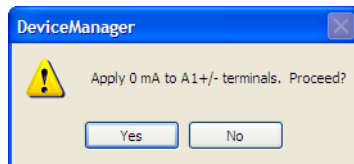

You are now prompted to apply 20 mA to the positive (+) and negative (-) terminals. Once that is done, click **Yes** to proceed.

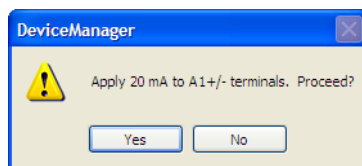

Once calibration is successfully completed, click **OK** to finish the process.

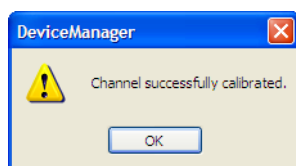

Resetting Calibration Data

You can reset the I/O channels calibrations to the factory calibrations in DeviceManager by selecting **Tools, I/O Channels, Reset Calibrate Data** or in WebManager by selecting **Administration, Reset, I/O Calibration**.

Setting the IOLAN's Date and Time

When you set the IOLAN's time, the connection method and time zone settings can affect the actual internal clock time that is being set. For example, if you are connecting to the IOLAN through the DeviceManager and your PC's time zone is set to Pacific Standard Time (GMT -8:00) and the IOLAN's time zone is set to Eastern Standard Time (GMT -5:00), the IOLAN's time is actually three hours ahead of your PC's time. Therefore, if you set the IOLAN's time to 2:30 pm in the DeviceManager, the IOLAN's actual internal clock time is 5:30 pm. This is the only configuration method that interprets the time and converts it between time zones, as necessary.

All other configuration methods set the IOLAN's internal clock time to the time specified, with no interpretation.

To set the IOLAN's system clock in DeviceManager, select **Tools, Advanced, Set Unit Time/Date**. The Set Date/Time window is displayed.

Note: IOLAN DS1 and TS2 models do not retain the date/time settings when the unit is rebooted.

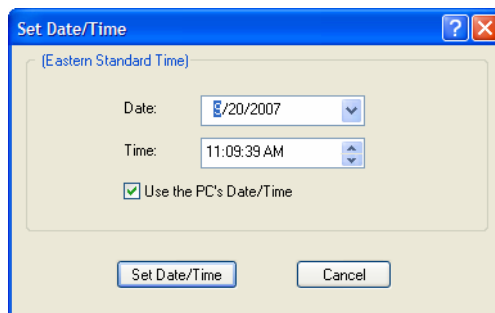

Configure the following parameters:

Date	The IOLAN's date. The format of the IOLAN's date is dependent on the Windows operating system and regional settings.
Time	The IOLAN's internal clock time, based on your PC's time zone. For example, if your PC's time zone is set to Pacific Standard Time (GMT -8:00) and the IOLAN's time zone is set to Eastern Standard Time (GMT -5:00), the IOLAN's time is three hours ahead of your PC's time. If you set the IOLAN's time to 2:30 pm, the IOLAN's actual internal clock time is 5:30 pm.
Use the PCs Date/Time	When enabled, sets the IOLAN's time to the PCs time. Default: Enabled This option is unique to the DeviceManager.

Rebooting the IOLAN

When you download any file (configuration, keys, certificates, firmware, etc.) to the IOLAN, you must reboot the IOLAN for it to take effect by selecting **Tools, Reset, Reboot Server** in DeviceManager and **Administration, Reboot Unit** in WebManager.

Resetting the Serial Port Statistics

You can reset the IOLAN's serial port statistics back to zero.

Resetting the IOLAN to Factory Defaults

You can reset the IOLAN to its factory default configuration by selecting **Tools, Reset, Reset to Factory Default** in DeviceManager and **Administration, Reset, Factory Defaults** in WebManager. The IOLAN will automatically reboot itself with the Perle factory default or custom factory default configuration.

Language Support

Two language files, in addition to English, are supplied on the supplemental CD, French and German. You can use any of these language files to create a translation into a language of your choice. You can download the language file (whether the language is supplied or translated) into the IOLAN and select the **Language** option of **Custom Language** or **Customlang** (custom language), making the Menu and CLI field labels display in the desired language.

You can view Menu or CLI in one other language only (as well as English). If you download another language file, this new language will replace the first language you downloaded.

You can revert to English at any time; the English language is stored permanently in the IOLAN and is not overwritten by your new language. Each user logged into the IOLAN can operate in either English or the downloaded language.

Loading a Supplied Language

This section describes how to download a language file using the CLI, since it is the least intuitive method. French and German language files are provided on the supplemental CD.

To load one of the supplied languages into the IOLAN, so the Menu or CLI fields appear in another language, do the following:

1. Open the supplemental CD and identify the language file, either `Iolan_ds_French.txt` or `Iolan_ds_German.txt`, or supply one of your own translated files.
2. Copy the language file to a host machine on the network; place it in the main file system or on the main hard drive.
3. Either use the TFTP defaults in the IOLAN or, configure as necessary, TFTP in the IOLAN.
4. In the CLI of the IOLAN, enter the host IP address and file name; for example,

```
netload customlang 172.16.4.1 /temp/Iolan_ds_French.txt
```

The IOLAN will download the language file via TFTP.

In DeviceManager select **Tools, Advanced, Custom Files** and then select **Download Custom Language File** and browse to the language file. In WebManager select **Administration, Custom Files** and then specify the **Custom Language File** option and browse to the language file.

5. To set an individual user to the new language, go to the **Users** menu and, in the **Language** field select **Customlang**. In the CLI (only) you can set individual users or all users to the new language; see the `set user *` command.
6. The user will see the change of language when he/she logs out (**Main Menu, Sessions Menu, Logout**) and logs back into the IOLAN. If, as Admin user, you change your language setting to **Customlang**, you will see the text menus display in the new language when you save and exit the **Change User** form. Users with **Level Normal** can also change their display language.

Note: If you download a new software version, you can continue to use your language unchanged; however, we recommend translating the new strings, which will be added to the end of the language file. A **Reset to Factory Defaults** will reload the **Customlang** as English.

On successful download, the **Customlang** in the IOLAN will be overwritten by the new language.

Translation Guidance

To help you with your translation, of supplied ASCII text language files we offer the following guidance:

- The IOLAN will support languages other than English (and the supplied German and French languages). The English language file, `english.txt`, displays the character length of each line at the beginning of the line. If a translated line goes over that character length, it will be displayed truncated in the Menu or CLI.
- Translate line for line, do not omit lines if you do not know the translation; leave the original untranslated text in place. Also, you must maintain the same sequential order of lines. It is a good practice to translate the file using a text editor that displays line numbers, so you can periodically verify that the line sequence has not changed from the original file (by comparing it to the original file).
- Keep all translations in quotes, otherwise the line will not display properly.
- Each line must end with a carriage return.
- If a line contains only numbers, for example 38400, leave that line in place, unchanged (unless you are using a different alphabet).

Software Upgrades and Language Files

If you receive a software upgrade for the IOLAN, the language files supplied on the supplemental diskette/CD might also have been updated. We will endeavour to provide a list of those changes in another text file on the same supplemental CD.

Note: The upgrade of your software (firmware) will not change the display of the language in the Menu or CLI.

If you are already using one of the supplied languages, French or German, you probably want to update the language file in the IOLAN. Until you update the IOLAN with the new language file, new text strings will appear in English.

If you are already using a language translated from an earlier version, you probably want to amend your translation. When a language file is updated, we will try to maintain the following convention:

1. New text strings will be added to the bottom of the file (not inserted into the body of the existing file).
2. Existing text strings, if altered, will be altered in sequence; that is, in their current position in the file.
3. The existing sequence of lines will be unchanged.
4. Until you have the changes translated, new text strings will appear in the Menu or CLI in English.

Downloading Terminal Definitions

All terminal types can be used on the IOLAN. Some terminal types which are not already defined in the IOLAN, however, are unable to use Full Screen mode (menus) and may not be able to page through sessions properly. When installed, the IOLAN has several defined terminal types—Dumb, WYSE60, VT100, ANSI, TVI925, IBM3151, VT320-7, and HP700/44.

If you are not using, or cannot emulate, any of these terminal types, you can add up to three additional terminal definitions to the IOLAN. The terminal definitions can be downloaded from a TCP/IP host.

To download terminal definitions, follow these steps:

1. Decide which TCP/IP host you are going to use. It must be a machine with enabled.
2. Configure TFTP in the IOLAN as necessary.
3. Select **Tools, Advanced, Custom Files** from the menu bar.
4. From the **File Type** drop-down, select **Download Terminal Definition**. Select the terminal definition option **1, 2, or 3** and then browse to the terminal definition file that is being downloaded to the IOLAN.
5. In the **Terminal** profile, select the **Terminal Type Termx** that you custom defined.

Creating Terminal Definition Files

To create new terminal definition files, you need to copy and edit the information from the terminfo database.

1. On a UNIX host, change directory to `/usr/lib/terminfo/x` (where **x** is the first letter of the required terminal type). For a Wyse60, for example, you would enter the command `cd /usr/lib/terminfo/w`.
2. The termcap files are compiled, so use the command `infocmp termfile` to read the required file (for example: `infocmp wy60`).
3. Check the file for the attribute `xmc#n` (where **n** is greater than or equal to 1). This attribute will corrupt menu and form displays making the terminal type unsuitable for using Menu mode.
4. If the terminal definition is suitable, change to a directory of your choice.
5. Rename and copy the file to the directory specified at step 4. using the command `infocmp termfile > termn` where **n** is greater than or equal to 1; (for example, `infocmp wy50 > term1`). Make sure the file has global read and execute permission for its entire path.
6. Edit the file to include the following capabilities in this format:

```
term=
acsc=
bold=
civis=
clear=
cnorm=
cup=
rev=
rmacs=
rmso=
smacs=
smso=
page=
circ=
```

For example:

```
term=AT386 | at386| 386AT |386at |at/386 console
acsc=jYk?lZm@qDtCu4x3
bold=\E[1m
civis=
clear=\E[2J\E[H
cnorm=
cup=\E[%i%p1%02d;%p2%02dH
rev=\E4A
rmacs=\E[10m
rmso=\E[m
smacs=\E[12m
smso=\E[7m
page=
circ=n
```

Note: As you can see from the example, capabilities which are not defined in the terminfo file must still be included (albeit with no value). Each entry has an 80 character limit.

On some versions of UNIX, some of the capabilities are appended with a millisecond delay (of the form \$<n>). These are ignored by the IOLAN and can be left out.

The 'acsc' capability, if defined, contains a list of character pairs. These pairs map the characters used by the terminal for graphics characters to those of the standard (VT100) character set.

Include only the following character pairs:

ix, kx, lx, mx, qx, tx, ux and *xx*

(where *x* must be substituted by the character used by the terminal). These are the box-drawing characters used to display the forms and menus of Menu mode. They must be entered in this order.

The last two capabilities will not be found in the terminfo file. In the **page** field you must enter the escape sequence used by the terminal to change screens. The **circ** field defines whether the terminal can use **previous page** and **next page** control sequences. It must be set to **y** or **n**. These capabilities can be found in the documentation supplied with the terminal.

Resetting Configuration Parameters

You can reset the IOLAN to its factory default settings (this will reset it to the original factory default or custom factory default settings, depending on what has been configured) through any of the following methods:

- You can push in the recessed button at the back of the IOLAN hardware for three to ten seconds (pushing it in and then quickly releasing will just reboot the IOLAN)
- DeviceManager, select **Tools, Reset, Reset to Factory Defaults**
- CLI, at the command line type, **reset factory**
- WebManager, select **Administration, Reset, Factory Default**, and then click the **Reset to Factory Defaults** button
- Menu, select **Network Configuration, Reset to Factory Defaults**
- SNMP, in the **adminInfo** folder, **set** the **adminFunction** variable to **2**

Lost admin Password

If the admin user password is lost, there are only two possible ways to recover it:

- reset the IOLAN to the factory defaults
- have another user that has **Admin** level rights, if one is already configured, reset the admin password



Virtual Modem AT Commands

Virtual Modem Initialization Commands

Note: Virtual Modem initialization commands are only supported on IOLAN firmware and configurators version 3.2 or higher.

You can initialize the modem connection using any of the following commands:

Command	Description	Options
ATQn	Quite mode. Determines if result codes will be sent to the connected terminal. Basic results codes are OK, CONNECT, RING, NO CARRIER, and ERROR. Setting quite mode also suppresses the "RING" message for incoming calls.	n=0, no result codes will be sent. n=1, result codes will be sent. (default)
ATVn	Verbose mode. Determines if result codes are displayed as text or numeric values.	n=0, display as numeric values. n=1, display as text. (default)
ATEn	Echo mode. Determines whether characters sent from the serial device will be echoed back by the IOLAN when VModem is in "command" mode.	n=0, disable echo. n=1, enable echo. (default)
+++ATH	Hang up. This command instructs the IOLAN to terminate the current session and go into "command" mode.	
ATA	Answer call. Instructs the VModem to accept connection requests. VModem will give the terminal up to 3 minutes to answer the call. If the ATA is not received within 3 minutes, all pending sync messages will be discarded.	
ATI0	Return the modem manufacturer name.	
ATI3	Return the modem model name.	
ATS0	Sets the value of the S0 register. The S0 register controls the "auto answer" behavior. In "manual" mode, the IOLAN will not accept incoming sessions until an ATA is issued by the serial device. In "auto answer" mode, the IOLAN will automatically accept an incoming connection request.	Register=0, sets "manual answer" mode Register=1-255, "auto answer" mode (default)

Command	Description	Options
AT&Z1	Set command allows the user to store an IP address and port number or phone number to use when making a connection. The user will issue an ATDS1 to cause the IOLAN to initiate the connection.	
AT&Sn	Sets the behavior of IOLAN's DTR signal. (DSR from a DCE perspective)	n=0, DTR signal always high. (default) n=2, DTR signal acts as DCD. n=3, DTR signal acts as RI.
AT&Rn	Sets the behavior of IOLAN's RTS signal. (CTS from a DCE perspective) If line is configured for hardware flow control, the RTS is used for this purpose and the setting of this command is ignored.	n=0, RTS always high. (default). n=3, RTS signal acts as DCD. n=4, RTS signal acts as RI.
AT&Cn	Sets the behaviour of the DCD signal.	n=0, DCD always on. n=1, DCD follows state of connection (off when no connection, on when TCP connection exists). (default)
AT&F	Sets the modes back to the factory defaults. This is a hard-coded default configuration which does not look at any user configuration.	
ATS2	Sets the value of the S2 register. The S2 register controls which character is used to enter "command" mode. (this is the potential replacement for the +++ (default) in front of the ATH command). This register will hold the hex value of the "escape" character. Any value > 27 will disable the ability to escape into "command" mode.	
ATS12	Sets the value of the S12 register. The S12 register controls the minimum length of idle time which must elapse between the receipt of the escape character and the A (first character of the ATH sequence). Units are 1/50th of a second. The default is 50 = 1 second.	
ATO	(ATD with no phone number) Establishes a connection using the IP and port specified in the telephone number field.	
ATDS1	Establishes a connection using the IP and port (or phone number) specified in the Phone Number field (stored by the AT&Z1 command).	



Pinouts and Cabling Diagrams

Serial Pinouts

DB25 Male

This section defines the pinouts for the DB25 male connection used on the 1-port IOLAN.

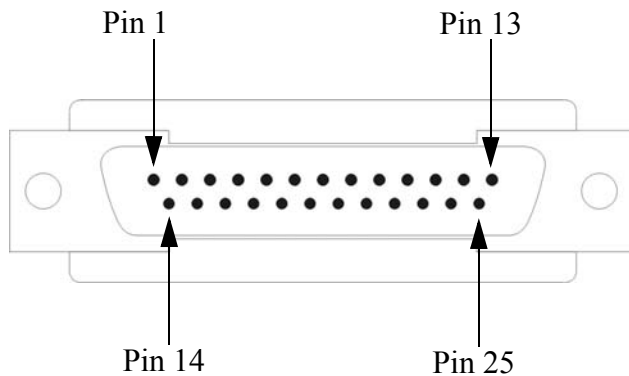

The following table provides pinout information:

Pinout	EIA-232	EIA-422	EIA-485 Full Duplex	EIA-485 Half Duplex
1	Shield	Shield	Shield	Shield
2 (out)	TxD			
3 (in)	RxD			
4 (out)	RTS			
5 (in)	CTS			
6 (in)	DSR			
7	GND	GND	GND	GND
8 (in)	DCD			
12	Power in	Power in	Power in	Power in
13		CTS-		
14		TxD+	TxD+	DATA+
15		TxD-	TxD-	DATA-
18		RTS+		
19		RTS-		

Pinout	EIA-232	EIA-422	EIA-485 Full Duplex	EIA-485 Half Duplex
20 (out)	DTR			
21		RxD+	RxD+	
22		RxD-	RxD-	
25		CTS+		

The power in pin, pin 12, can be 9-30V DC.

DB25 Female

This section defines the pinouts for the DB25 female connection used on the 1-port IOLAN.

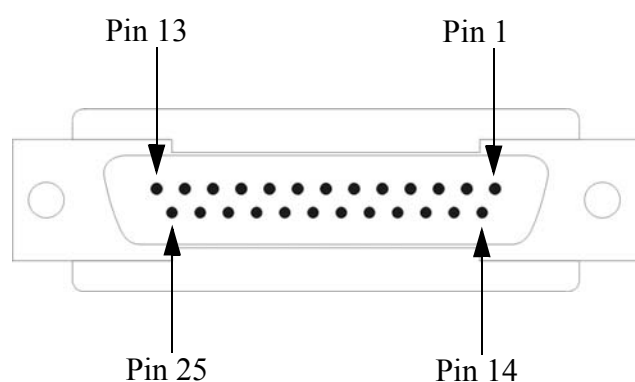

The following table provides pinout information:

Pinout	EIA-232	EIA-422	EIA-485 Full Duplex	EIA-485 Half Duplex
1	Shield	Shield	Shield	Shield
2 (in)	RxD			
3 (out)	TxD			
4 (in)	CTS			
5 (out)	RTS			
6 (out)	DTR			
7	GND	GND	GND	GND
8 (in)	DCD			
12	Power in	Power in	Power in	Power in
13		RTS-		
14		RxD+	RxD+	
15		RxD-	RxD-	
18		CTS+		
19		CTS-		
20 (in)	DSR			

Pinout	EIA-232	EIA-422	EIA-485 Full Duplex	EIA-485 Half Duplex
21		TxD+	TxD+	DATA+
22		TxD-	TxD-	DATA-
25		RTS+		

The power in pin, pin 12, can be 9-30V DC.

RJ45

This section defines the pinouts for the RJ45 connection used on the DS and TS IOLAN. The TS IOLAN does not support power in, so use the 8-pin mappings for this model. These pinouts do not apply to I/O models.



The following table provides pinout information:

Pinout 10-pin	Pinout 8-pin	EIA-232	EIA-422	EIA-485 Full Duplex	EIA-485 Half Duplex
1		Power In	Power In	Power In	Power In
2 (in)	1	DCD			
3 (out)	2	RTS	TxD+	TxD+	DATA+
4 (in)	3	DSR			
5 (out)	4	TxD	TxD-	TxD-	DATA-
6 (in)	5	RxD	RxD+	RxD+	
7	6	GND	GND	GND	GND
8 (in)	7	CTS	RxD-	RxD-	
9 (out)	8	DTR			

The power in pin, Pin 1, can be 9-30V DC. The 2-port IOLAN has power in on Port 2 only.

DB9 Male (Serial Only)

This section defines the pinouts for the DB9 male connection used on the 1-port IOLAN that is serial only (not I/O).

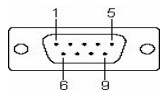

The following table provides pinout information:

Pinout 9-pin	EIA-232	EIA-422/485 Full Duplex	EIA-485 Half Duplex
1 (in)	DCD		
2 (in)	RxD	RxD+	
3 (out)	TxD	TxD+	TxD+/RxD+
4 (out)	DTR		
5	GND	GND	GND
6 (in)	DSR	RxD-	
7	RTS		
8 (in)	CTS		
9		TxD-	TxD-/RxD-

DB9 Male I/O

This section defines the pinouts for the DB9 male connection used on the 1-port IOLAN I/O models.

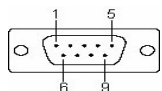

The following table provides pinout information:

Pinout 9-pin	EIA-232	EIA-422/485 Full Duplex	EIA-485 Half Duplex
1(in)	DCD		
2 (in)	RxD	RxD+	
3 (out)	TxD	TxD-	TxD-/RxD-
4 (out)	DTR		
5	GND	GND	GND
6 (in)	DSR	RxD-	
7	RTS	TxD+	TxD+/RxD+
8 (in)	CTS		
9			

EIA-232 Cabling Diagrams

This section shows how to create EIA-232 cables that are compatible with the Device Server.

Terminal DB25 Connector

The following diagrams show how the null modem cable should be configured when connecting to a terminal DB25.

DB25 Male

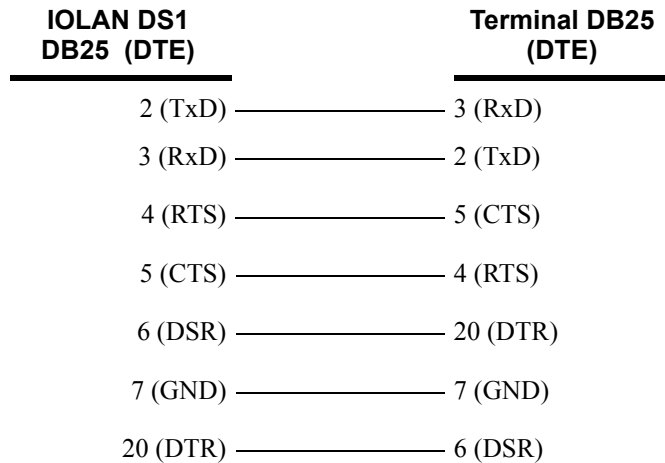

DB25 Female

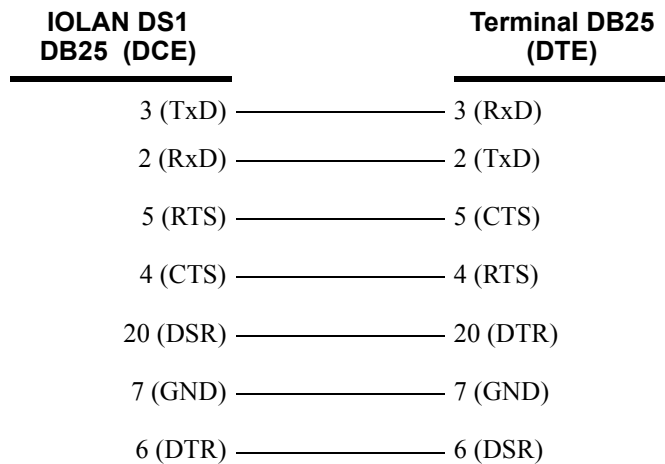

RJ45

IOLAN RJ45			Terminal DB25 (DTE)
10-pin	8-pin		
4 (DSR)	3	—————	20 (DTR)
3 (RTS)	2	—————	5 (CTS)
5 (TxD)	4	—————	3 (RxD)
6 (RxD)	5	—————	2 (TxD)
7 (GND)	6	—————	7 (GND)
8 (CTS)	7	—————	4 (RTS)
9 (DTR)	8	—————	6 (DSR)

DB9 Male

IOLAN DS1 DB9 Male		Terminal DB25 (DTE)
3 (TxD)	—————	3 (RxD)
2 (RxD)	—————	2 (TxD)
7 (RTS)	—————	5 (CTS)
8 (CTS)	—————	4 (RTS)
6 (DSR)	—————	20 (DTR)
5 (GND)	—————	7 (GND)
4 (DTR)	—————	6 (DSR)

Modem DB25 Connector

The following diagrams show how a standard straight through cable should be configured when connecting to a DB25 modem.

DB25 Male

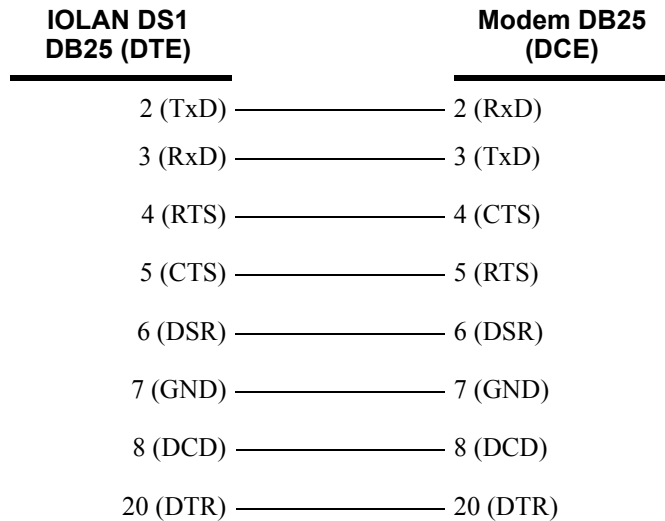

RJ45

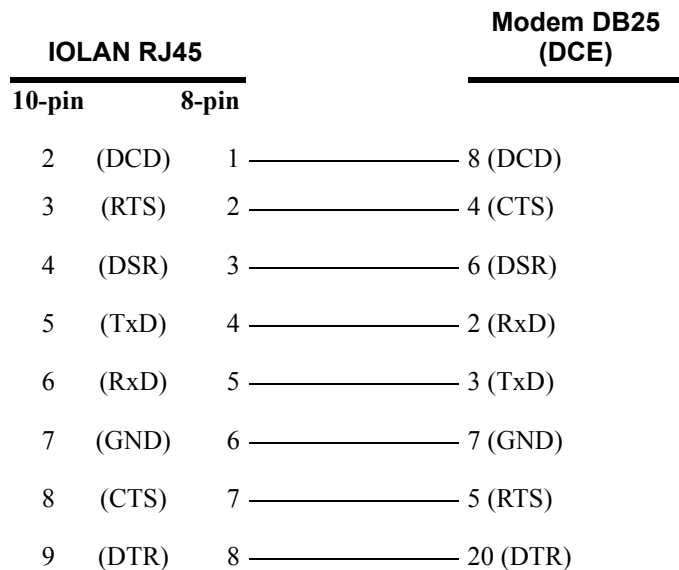

DB9 Male

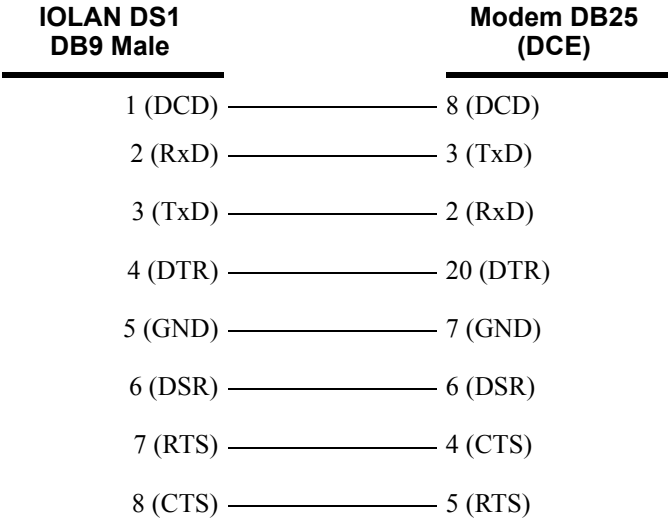



Setting Jumpers

Introduction

The IOLAN contains jumpers that you might need to set before you configure it and put it into production. You can set the IOLAN line termination to **on** or **off** (this is **off** by default) if you are using EIA-422/485 (not applicable for I/O models).

1-Port IOLAN

IOLAN DB25 Male/Female

To change the settings, do the following:

1. Unplug the IOLAN from the electrical outlet and disconnect everything from the box.
2. Open the case by unscrewing the two side screws, one on each side, and lifting off the top of the case. You should see the following:

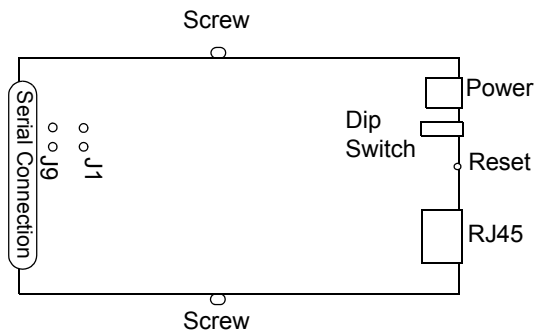

3. To turn line termination **on**, locate and jumper both J1 and J9.
4. Close the IOLAN case by replacing the case lid and the two screws. You can now power it on with the new settings.

IOLAN RJ45

To change the settings, do the following:

1. Unplug the IOLAN from the electrical outlet and disconnect everything from the box.
2. Open the case by unscrewing the two side screws, one on each side, and lifting off the top of the case. You should see the following:

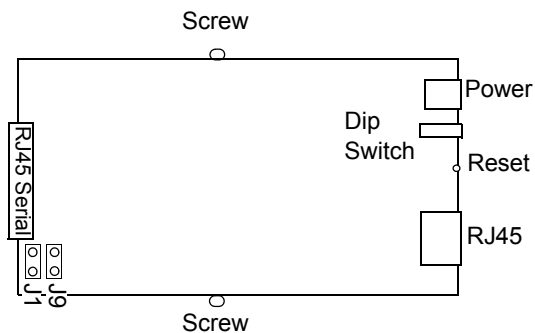

3. To turn line termination **on**, locate and jumper both J1 and J9.
4. Close the IOLAN case by replacing the case lid and the two screws. You can now power it on with the new settings.

IOLAN DB9

To change the settings, do the following:

1. Unplug the IOLAN from the electrical outlet and disconnect everything from the box.
2. Open the case by unscrewing the two side screws, one on each side, and lifting off the top of the case. You should see the following:

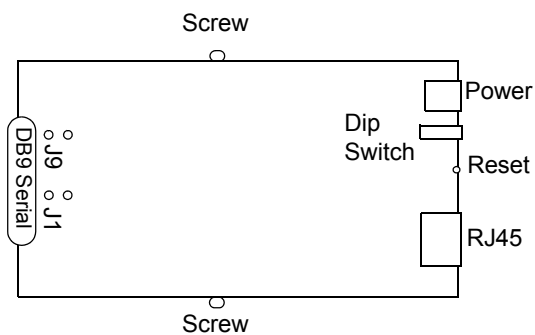

3. To turn line termination **on**, locate and jumper both J1 and J9.
4. Close the IOLAN case by replacing the case lid and the two screws. You can now power it on with the new settings.

2-Port IOLAN

To change the settings, do the following:

1. Unplug the IOLAN from the electrical outlet and disconnect everything from the box.
2. Open the case by unscrewing the two side screws, one on each side, and lifting off the top of the case. You should see the following:

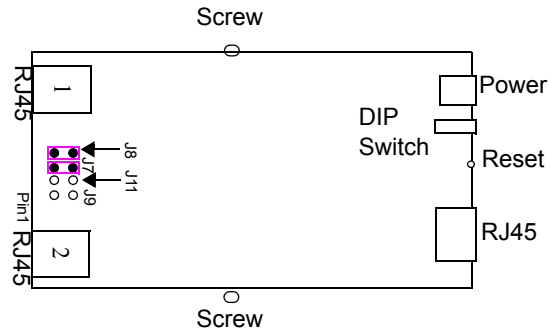

3. To turn line termination **on** for Line 1, locate and jumper both J7 and J8 (as shown in the diagram). To turn line termination **on** for Line 2, locate and jumper both J11 and J9.
4. Close the IOLAN case by replacing the case lid and the two screws. You can now power it on with the new settings.

Digital I/O Module

IOLANs that have Digital I/O have an input/output jumper that must be set for each channel and must match the software configuration for each channel. Depending on the model, the placement of the digital I/O board can change, so the diagram below shows how to set jumper for any digital board. To change the settings, do the following:

1. Detach the IOLAN from the electrical power source and disconnect everything from the box.
2. Open the case by unscrewing the five side screws, two on each side plus the grounding screw, and lifting off the top of the case. You should see the following configuration for the digital I/O board:

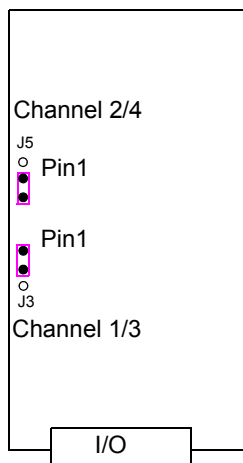

Note: Jumper pins 1 and 2 for Input. Jumper pins 2 and 3 for Output.

3. To configure either Channel 1 or Channel 3 (depending on how many Digital channels your I/O supports and following the mylar channel definitions) for Input, jumper J3 pin 1 and 2 (as shown); this is the default setting. To configure either Channel 2 or Channel 4 (depending on how many Digital channels your I/O supports and following the mylar channel definitions) for Output, jumper J5 pin 2 and 3 (as shown).
4. Close the IOLAN case by replacing the case lid and the five screws. You can now power it on with the new settings.

Analog Input Module

IOLANs that have Analog Input have a voltage/current jumper that must be set for each channel and must match the software configuration for each channel. To change the settings, do the following:

1. Detach the IOLAN from the electrical power source and disconnect everything from the box.
2. Open the case by unscrewing the five side screws, two on each side plus the grounding screw, and lifting off the top of the case. You should see the following configuration for the analog input board:

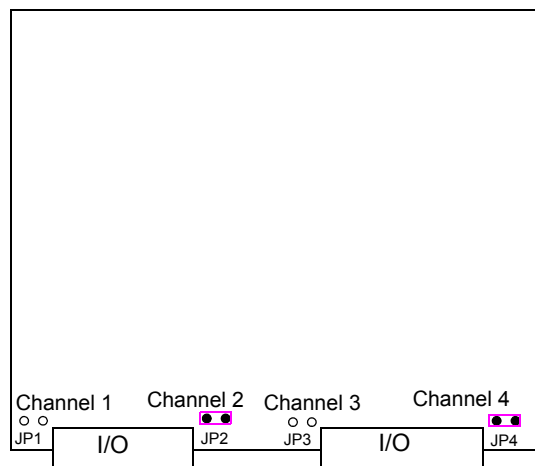

3. To configure Channel 1 for Voltage, no jumper should be set (as shown); this is the default setting. To configure Channel 2 for Current, jumper both J2 pins (as shown).
4. Close the IOLAN case by replacing the case lid and the five screws. You can now power it on with the new settings.



I/O Wiring Diagrams

Wiring I/O Diagrams

This section describes how to wire the various IOLAN I/O models.

Digital I/O

Make sure the Digital I/O jumpers support the software setting; see [Digital I/O Module](#) for jumper settings.

Digital Input Wet Contact

If you are using a wet contact for your Digital input, for channel D1 connect one wire to D1 and the other wire to GND. The power source is supplied by external sources.

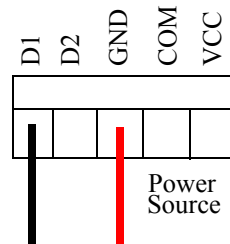

Digital Input Dry Contact

If you are using a dry contact for your Digital input, for channel D1 connect one wire to D1 and the other wire to COM. The power source is supplied by the COM (common) connector.

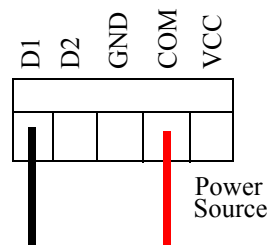

Digital Output Sink

For a Digital output sink (ground) configuration for channel D1, follow the diagram below.

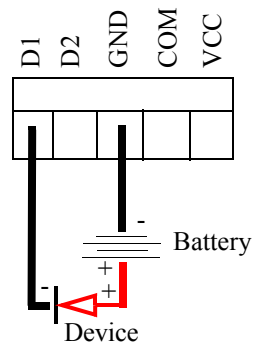

Digital Output Source

For a Digital output source (voltage) configuration for channel D1, follow the diagram below.

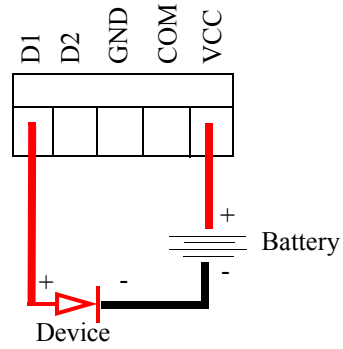

Analog Input

Make sure the Analog jumpers support the software setting; see [Analog Input Module](#) for jumper settings.

Current

To connect channel A1 with a 2-wire shielded cable, connect the positive wire to A1+, the negative wire to A1-, and optionally the shield to GND.

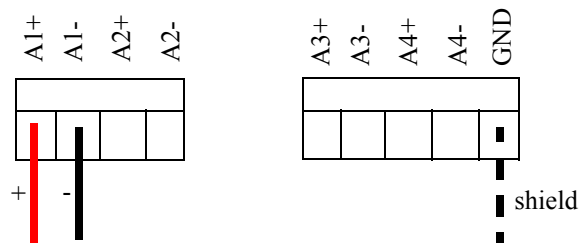

If you have the positive/negative wires reversed, the output will always read 0 (zero).

Voltage

To connect to Channel A1 with a 2-wire shielded cable, connect the positive wire to A1+, the negative wire to A1-, and optionally the shield to GND.

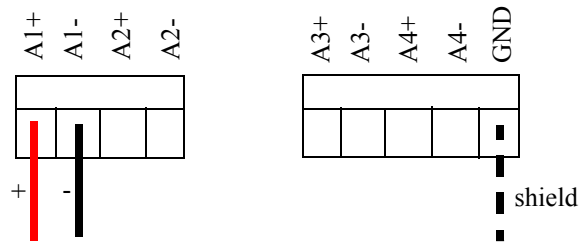

If you have the positive/negative wires reversed, the polarity of the voltage will be reversed.

Temperature Input

If you are using RTD sensors, a short detected status will be displayed if the wires are connected improperly. RTD or thermocouple sensors will display an open detection status when the circuit is broken.

Thermocouple

To connect to Channel A1 with a 2-wire cable, connect the positive wire to A1+ and the negative wire to A1-; you will not be using the A1s connection.

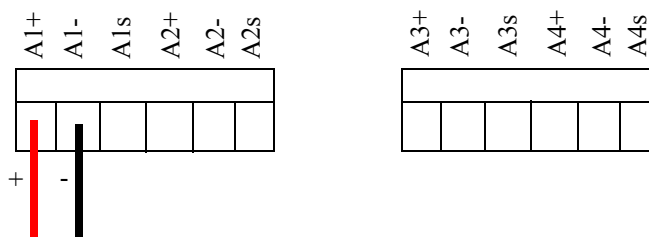

RTD 2-Wire

In a 2-wire RTD configuration, connect the excite wire to A1-, the return wire to A1+, and jumper the sense wire from A1s with a insulated wire going to A1+.

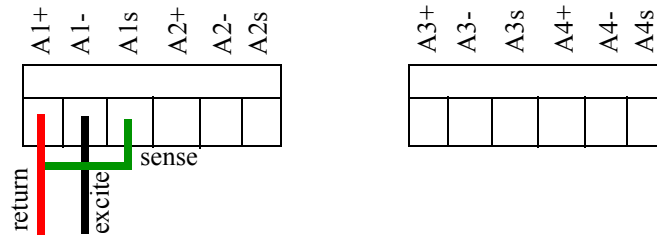

RTD 3-Wire

In a 3-wire RTD configuration, connect the return wire to A1+, the excite wire to A1-, and the sense wire to A1s.

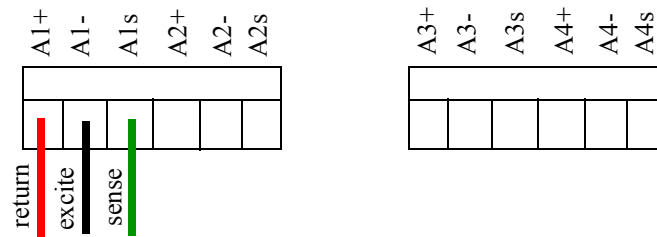

RTD 4-Wire

In a 4-wire RTD configuration, connect the return wire to A1+, the excite wire to A1-, the sense wire to A1s, and leave the fourth wire disconnected.

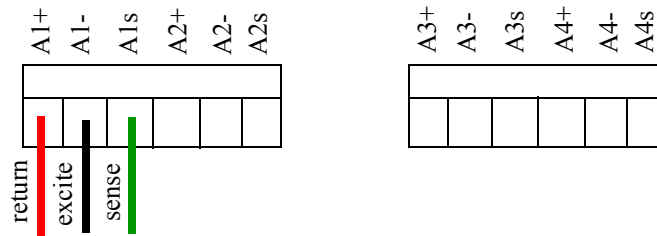

Relay Output

Normally Open Contact

To connect Relay channel R1 for a circuit that is normally inactive, connect one wire to the COM (common) connector and one wire to the NO (normally open) connector.

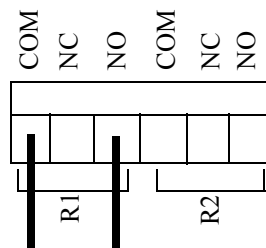

Normally Closed Contact

To connect relay channel R1 for a circuit that is normally active, connect one wire to the COM (common) connector and one wire to the NC (normally closed) connector.

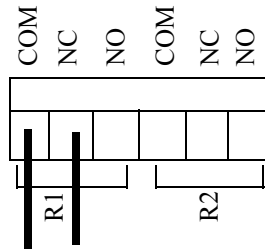



TruePort Utility

Introduction

This chapter provides information on the TruePort utility.

TruePort

TruePort is a com port redirector utility for the IOLAN. It can be run in two modes:

- **TruePort Full mode**—This mode allows complete device control and operates exactly like a directly connected serial port. It provides a complete COM port interface between the attached serial device and the network.
- **TruePort Lite mode**—This mode provides a simple raw data interface between the device and the network. Although the port will still operate as a COM port, control signals are ignored. In this mode, the serial communications parameters must be configured on the IOLAN.

You use TruePort when you want to connect extra terminals to a server using the IOLAN rather than a multi-port serial card. When run on UNIX, TruePort allows you to print directly from a terminal to an attached printer (transparent printing). You can also remap the slow baud rate of your UNIX server to a faster baud rate, as shown below.

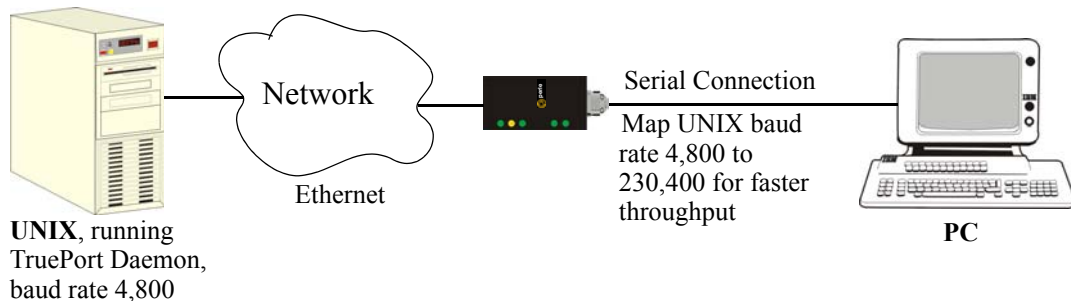

Currently, TruePort is supported on Linux[®], Windows[®], SCO[®], Solaris[®], and others. For a complete list of supported operating systems, see the Perle website.

For more information, see the *TruePort User Guide*.

API I/O Access Over TruePort

You can access IOLAN I/O data through TruePort using the Perle API. The API uses the command/response format. See the `ioapiotp.c` sample program, found on the product CD-ROM, for an example implementation.

API Request Format

All data in the Request must be sent as a single write to the COM port. The API command takes the following format:

Number of Bytes	Value
1	Function Code (in hex): <ul style="list-style-type: none"> ● 01—Get read/write boolean register ● 03—Get read/write register ● 04—Get read only register ● 15—Set read/write boolean register (0x0F) ● 16—Set read/write register (0x10)
2	Starting register number (see <i>A4/T4 Registers</i> , <i>A4D2/A4R2 Registers</i> , or <i>D4/D2R2 Registers</i> for this value).
2	Number of registers to act on starting from the register defined in byte 2 above.
n	Data for write. Some values must be read/written as a unit consisting of 2 consecutive registers. If the request is to write, the data to write follows the number of registers. If accessing registers consisting of 2 bytes or 4 bytes, the data is in big endian (network order) format.

API Response Format

The API command takes the following response format:

Number of Bytes	Value
1	Function code of request if no error. Most significant bit will be set if an error occurred.
1	Length of data in response if no error occurred. If an error occurred, the byte will contain the error code (see the <i>Error Codes</i> table below).
n	Data response for request (the number of bytes is dependent on the number and type of registers requested). If the request returns 2 or 4 byte values, it will be in big endian (network order) format. If the request returns boolean values, the least significant bit (bit 0) represents the first value requested and bits 1 to 7 represents subsequent boolean values. If more than 8 boolean registers are requested, they are returned in successive bytes.

Error Codes

Code	Name	Description
01	Illegal Function	The function code received in the query is not an allowable action for the server (or slave).
02	Illegal Data Address	The data address received in the query is not an allowable address for the server (or slave).
03	Illegal Data Value	A value contained in the query data field is not an allowable value for server (or slave).
04	Slave Device Failure	An unrecoverable error occurred while the server (or slave) was attempting to perform the requested action.



Accessories

Introduction

This chapter provides information about peripheral IOLAN options that can be ordered separately from the product. Contact your sales representative to find out how to order the products listed in this appendix.

Starter Kit (Adapters/Cable)

The IOLAN Starter Kit includes the following:

- *RJ45F to DB25M DTE Crossover Adapter*
- *RJ45F to DB25M DCE Modem Adapter*
- *RJ45F to DB25F DTE Crossover Adapter*
- *RJ45F to DB9M DTE Crossover Adapter*
- *RJ45F to DB9F DTE Crossover Adapter*
- *Sun/Cisco RJ45M Connector Cable for Rack Mount Models*

The adapters/cable can be purchased as a kit or individually.

RJ45F to DB25M DTE Crossover Adapter

The following diagram shows the IOLAN RJ45F-->DB25M DTE crossover adapter pinouts. This is model number DBA0011.

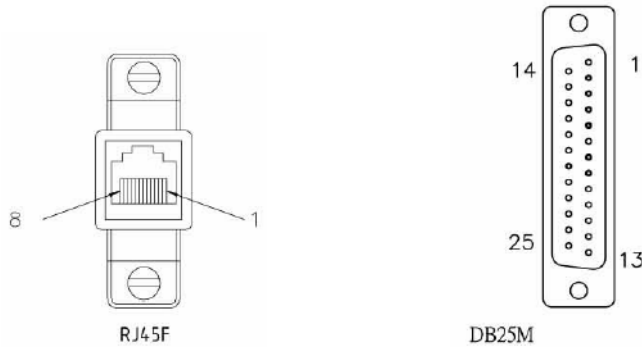

RJ45F	DB25M DTE
(TxD) 4	3 (RxD)
(RxD) 5	2 (TxD)
(GND) 6	7 (GND)
(DTR) 8	6 (DSR) 8 (DCD)
(DSR) 3	20 (DTR)
(RTS) 2	5 (CTS)
(CTS) 7	4 (RTS)

RJ45F to DB25M DCE Modem Adapter

The following diagram shows the IOLAN RJ45F→DB25M DCE modem adapter pinouts. This is model number DBA0013.

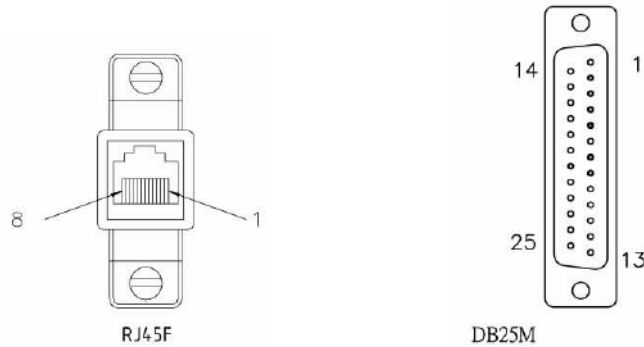

RJ45F	DB25M
(TxD) 4	2 (RxD)
(RxD) 5	3 (TxD)
(GND) 6	7 (GND)
(DTR) 8	20 (DTR)
(DSR) 3	6 (DSR)
(DCD) 1	8 (DCD)
(RTS) 2	4 (RTS)
(CTS) 7	5 (CTS)

RJ45F to DB25F DTE Crossover Adapter

The following diagram shows the IOLAN RJ45→DB25F DTE crossover adapter pinouts. This is model number DBA0010.

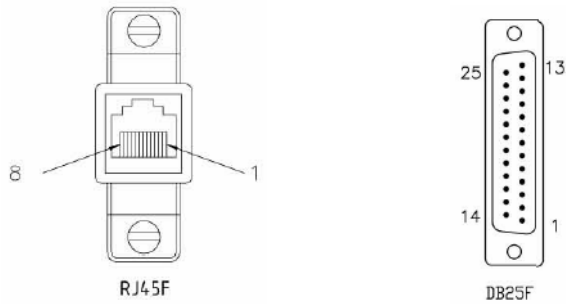

RJ45F	DB25F
(TxD) 4	3 (RxD)
(RxD) 5	2 (TxD)
(GND) 6	7 (GND)
(DTR) 8	6 (DSR) 8 (DCD)
(DSR) 3	20 (DTR)
(RTS) 2	5 (CTS)
(CTS) 7	4 (RTS)

RJ45F to DB9M DTE Crossover Adapter

The following diagram shows the IOLAN RJ45→DB9M crossover adapter pinouts. This is model number DBA0021.

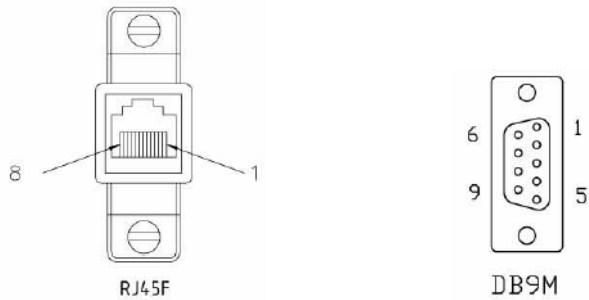

RJ45F	DB9M
(TxD) 4	2 (RxD)
(RxD) 5	3 (TxD)
(GND) 6	5 (GND)
(DTR) 8	1 (DCD) 6 (DSR)
(DSR) 3	4 (DTR)
(RTS) 2	8 (CTS)
(CTS) 7	7 (RTS)

RJ45F to DB9F DTE Crossover Adapter

The following diagram shows the IOLAN RJ45F→DB9F crossover adapter pinouts. This is model number DBA0020.

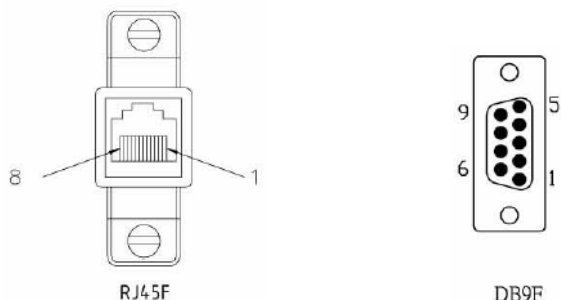

RJ45F	DB9F
(TxD) 4	2 (RxD)
(RxD) 5	3 (TxD)
(GND) 6	5 (GND)
(DTR) 8	1 (DCD) 6 (DSR)
(DSR) 3	4 (DTR)
(RTS) 2	8 (CTS)
(CTS) 7	7 (RTS)

Sun/Cisco RJ45M Connector Cable for Rack Mount Models

This is a 3 meter RJ45M→RJ45M 8-wire Sun/Cisco modular cable. The following diagram shows how the IOLAN RJ45M cable is configured when connecting to the supplied Sun/Cisco RJ45 cable. This model number is CAB0030.

Also available as an adaptor with an RJ45M for IOLAN side and an RJ45F for Sun/Cisco side. This is model number DBA0031. When using this adaptor, make sure to place it on the IOLAN side of the connection.

IOLAN RJ45M	Sun/Cisco RJ45M
(RTS) 2	8 (CTS)
(DSR) 3	2 (DTR)
(TxD) 4	6 (RxD)
(RxD) 5	3 (TxD)
(GND) 6	4 (GND)
(CTS) 7	1 (RTS)
(DTR) 8	7 (DSR)



Troubleshooting

Introduction

This chapter provides information that can help resolve problems with the IOLAN.

Hardware Problems

The IOLAN Power/Ready LED is red and stays red for over 10 seconds.

You have a hardware problem that might require factory service. First, try the following:

- If the IOLAN is not in Console mode, do the following:
 - a. Set up a direct connection to the IOLAN; see [Through the Serial Port](#) for information on this type of connection.
 - b. Power the IOLAN off.
 - c. Switch the Console dip switch to On.
 - d. Power the IOLAN on.

If there is a problem with the IOLAN firmware, you will need to reload the firmware, which can be found either on the CD-ROM that came with the IOLAN or on the Perle website, www.perle.com/downloads (when you access the webpage, select your specific IOLAN model).

- If the IOLAN is already in Console mode and the Power LED stays red, you need to make arrangements to return the IOLAN.

If you purchased the IOLAN less than 30 days before this problem appears, contact your distributor; otherwise, see the Perle web site (www.Perle.com) for factory service information. Note: no factory service can be performed on IOLANs that have not been registered.

The Power/Ready LED continues to blink green in desktop models.

This is not an error, the Power/Ready LED will blink green when serial port 1 is in Console Mode.

Communication Issues

General communication checks and practices are as follows:

- Are your cables connected and correctly configured? If you are using EIA-232, see [EIA-232 Cabling Diagrams](#) to verify that your cables are correctly configured.
- Can you ping your host? If you can ping but packet loss is reported, ping another host/device on the same network. This will tell you whether the problem is specific to the host/device or general to the network.
- After entering or changing IP information for your IOLAN, *reboot* the IOLAN (does not apply when using BOOTP or DHCP). Once the IOLAN has rebooted, other network devices should be able to communicate with it (ping, telnet, etc.). Also, protocols such as ARP and proxy-ARP will work properly.

- Use the **show routes** command (command line only) or view the **Routes** statistics. Is there a route to the host?
- If the WebManager or DeviceManager cannot communicate with the IOLAN, verify that the **Security, Services HTTP** parameter is enabled for WebManager and **DeviceManagerD** is enabled for DeviceManager.

DeviceManager Problems

Error Message: **16 bit Windows Subsystem - C:\WINDOWS\SYSTEM32\AUTOEXEC.NT. The system file is not suitable for running MS-DOS and Microsoft Windows applications. Choose 'Close' to terminate the application.**

The error message can be misleading, because it is displayed even if the **AUTOEXEC.NT** file is actually missing.

To verify whether you have the file, type `%windir%/system32/` in the address bar of an Explorer window. If there is no **AUTOEXEC.NT** file proceed as follows:

1. Browse to `%windir%/repair/` (usually `C:\WINDOWS\repair`).
2. Right-click and Copy the **AUTOEXEC.NT** file.
3. Browse to `%windir%/system32/` (usually `C:\WINDOWS\System32`).
4. Right-click inside the window and Paste the file.

The error condition described here may also be the result of corruption of the **AUTOEXEC.NT** file, in which case the above procedure may be helpful to restore a valid file.

If the above procedure does not fix the DeviceManager installation problem, see <http://support.microsoft.com/?kbid=324767> for the official Microsoft explanation.

Host Problems

Cannot access a host on a local network, verify:

- The network address is correct.
- The subnet mask is set correctly and reflects the network configuration.
- The broadcast address is set correctly and reflects the network configuration.

Cannot access a host on a remote network:

- Use the **show route** command to verify that there is a route to the remote host. If no gateway is specified, verify that a default gateway is specified. Ping the default gateway to check if it is working.
- Consider the situation beyond the gateway; for example, are intermediate gateways and the remote host available? Also, check the messages returned by the **ping** command; for example, that a particular host or gateway is unreachable.

Gateways added into the gateway table are ignored by the IOLAN:

- Have you used BOOTP and entered a single static gateway in the bootptab file entry? If yes, the other gateways will be ignored.

Access to host lost after a few minutes.

- If the route to this host goes through routers, make sure those routers are all sending RIP packets across the networks.

Login Problems

You have lost or don't know your password (as admin user).

- You must reset the IOLAN to its factory default settings using the **Reset** switch on the rear panel. There is no procedure to access the IOLAN without a password.

Problems with Terminals

The following section concerns problems with the appearance of data on your terminal screen.

The IOLAN logs me out after a few minutes:

- Check the **Idle Timer** value set for the user. The default setting for the **Idle Timer** for all users is 0 seconds (does not timeout).

Corrupt data.

- Check your line settings (baud rate, stop bits, etc.)

Missing data.

- Verify that the same type of flow control is set in both your terminal and on the IOLAN's port.

Error message not permitted on a dumb terminal after typing the CLI command screen.

- Set your **Line** to **Termtyp** VT100, ANSI or WYSE60 (or other form of terminal emulation, if you have downloaded one). The default line type in the IOLAN is **Dumb**, which does not support the graphics characters necessary to view the text-based menus.

Screen corruption when using the text-based menu system.

- Verify that the terminal setup in the IOLAN matches your terminal.
- Verify that entries in the term file match your terminal setup.
- If using a PC/computer, verify that the type of terminal emulation selected in your application matches those supported by the IOLAN.

When using the function keys on your keyboard, nothing happens or your sessions keep swapping.

- Change your **Hotkey Prefix** character. The function keys on the keyboards of some terminals (like WYSE60) send character sequences which begin with **^a**; unfortunately, **^a** is also the default **Hotkey Prefix**, which you use to switch between sessions. A valid alternative would be **^b** (hex=02). If you are the system administrator, you can change any user's **Hotkey Prefix** character.

When using a downloaded terminal definition, you are having problems using arrow keys.

- Use Ctrl-K, Ctrl-J, Ctrl-H and Ctrl-L for up, down, left and right respectively.

When switching from a session back to the text menus, both screen images are superimposed.

- Press **^r** to redraw the screen.

INIT: Error in terminal file <filename>

- This error indicates that you have exceeded the 80 character limit for one or more of the terminal capabilities defined in the reported file.

INIT: Error on line n in terminal file <filename>

- You have omitted the = sign from the reported line.

Unknown IP Address

You have already configured the IOLAN and you do know your password, but have lost, misconfigured, or don't know the IP address of the IOLAN, and you cannot obtain a login.

- If the IOLAN resides within the local network segment, you can use DeviceManager to find the IOLAN.
- You can connect directly to the serial port of the IOLAN, as explained in [Through the Serial Port](#).

DHCP/BOOTP Problems

Messages: host name too long or filename too long.

- The IOLAN can only accept host names of 14 characters or file names of 64 characters, so verify that you are not attempting to pass a string that is longer than those maximums.

DHCP or BOOTP have been set up to configure my IOLAN, but does not seem to have done anything.

- Check that the server DHCP/BOOTP service is set to on, if not set it to on and reboot.
- Check that your BOOTP server is configured for your IOLAN or that your DHCP server has an active lease pool (scope) with at least 1 free IP address.

You observe TFTP errors when the IOLAN boots, for example:

```
TFTP: File not found : filename
```

```
TFTP: Timed out
```

This has a number of causes, including:

- The file names you specified to DHCP/BOOTP do not exist or are in the wrong place.
- The server for any of the downloadable files in your bootfile has no TFTP server running.
- Verify that lease data in your DHCP server manager is correct.
- Reset or restart the DHCP server.

Language Problems

In a customized language, the text strings appear in the wrong place in the Menu or CLI.

- Check the original ASCII text file you used to translate to your customised language. The sequence of the line much match exactly (be aware that comments don't affect line sequence, but can affect the actual line that the strings appear on). So, if you strip out all comments, if the original file says line 1000 should be string **none**, then line 1000 (stripped of comments) should be the translated version of **none**.

Long Reboot Cycle

Rebooting the IOLAN takes a long time.

If you are not using DHCP/BOOTP, disable this within the Server Services; otherwise, the IOLAN waits to timeout for a request to DHCP/BOOTP.

I/O Models

An I/O Digital or Relay controlled motor is starting/stopping

- Digital and Relay channels have automatically resetting fuses, meaning that if the circuit gets overloaded and the fuse blows, it will automatically reset when the circuit cools down.

An A4R2 model is starting/stopping

- The A4R2 model can run at 55 degrees Celsius ambient temperature when the input voltage is 22VDC or below. If the input voltage exceeds 22VDC, the maximum ambient temperature will drop into the range of 45-50 degrees Celsius to run successfully.

IPv6 Issues

You are not seeing the IPv6 address value when you attempt to connect to the IOLAN.

Many Windows based systems have IPv6 support already enabled, however, if you need to install IPv6 then follow the procedure below.

To install IPv6 support in Windows® do the following:

1. In Control Panel, double-click the **Network Connections** icon.
2. Double-click the **Local Area Connection** entry.
3. In the Local Area Connection Status window, click the **Properties** button on the **General tab**.
4. In the Local Area Connections window, click the **Install** button on the **General tab**.
5. In the Select Network Component Type window, select **Protocol** and click the **Add** button.
6. In the Select Network Protocol window, select **Microsoft TCP/IP version 6** and click the **OK** button.

Contacting Technical Support

Making a Technical Support Query

Who To Contact

Note: Perle offers free technical support to Perle Authorized Distributors and Registered Perle Resellers.

If you bought your product from a registered Perle supplier, you must contact their Technical Support department; they are qualified to deal with your problem.

Have Your Product Information Ready

When you make a technical support enquiry please have the following information ready:

Item	Write Details Here
Product Name	
Problem Description	
Your Name	
Company Name and Address	
Country	
Phone Number	
Fax Number	
Email Address	

Making a support query via the Perle web page

If you have an internet connection, please send details of your problem to Technical Support using the email links provided on the Perle web site in the **Support/Services** area.

Click here to access our website at the following URL:

<http://www.perle.com>

Repair Procedure

Before sending the IOLAN for repair, you must contact your Perle supplier. If, however, you bought your product directly from Perle you can contact directly.

Customers who are in Europe, Africa or Middle East can submit repair details via a website form. This form is on the Perle website, www.perle.com, in the **Support/Services** area.

Click here to access our web site at the following URL:

http://www.perle.com/support_services/rma_form.asp

Feedback on this Manual

If you have any comments or suggestions for improving this manual please email Perle using the following address:

Email: ptac@perle.com

Please include the **title**, **part number** and **date** of the manual (you can find these on the title page at the front of this manual).



Data Logging

Introduction

This appendix provides additional information about the Data Logging feature.

Trueport Profile

The following features are not compatible when using Data Logging.

- Allow Multiple Hosts to connect
- Connect to Multiple Hosts
- Monitor DSR or DCD
- Signals high when not under Trueport client control
- Message of the day
- Session timeout

TCP Socket Profile

The following features are not compatible when using Data Logging.

- Allow Multiple Hosts to connect
- Connect to Multiple Hosts
- Monitor DSR or DCD
- Permit connections in both directions
- Authenticate user
- Message of the day
- Session timeout



Modbus Remapping

Introduction

This appendix provides additional information about the Modbus Remapping feature.

Modbus Remapping Feature

The Modbus remapping feature allows a TCP Modbus Master to poll a Modbus slave device and have the IOLAN translate the UID to a different UID for the slave device. The Master UID has to be unique on the IOLAN. The Slave UID must be unique on each serial port. The translate rules are controlled by a file downloaded to the IOLAN.

The following procedure will allow you to use the Modbus remapping feature:

Create a configuration file

- The file must be called "modbus_remap"
- One translate rule per line
- The fields on a line are separated by a comma

Line format for one UID is:

port,master_uid,slave_uid

- port: is the IOLAN port number that the slave is connected to
- master_uid: is the UID that the TCP Modbus Master uses
- slave_uid: is the UID that the Modbus slave uses

Line format for UID ranges is:

port,master_start-master_end,slave_start-slave_end

- port: is the IOLAN port number that the slave is connected to
- master_start: is the first master UID in the range
- master_end: is the last master UID in the range
- slave_start: is the first slave UID in the range
- slave_end: is the last slave UID in the range

Configuring the Modbus UID Translation Feature

1. On the serial port Modbus Gateway, configure Modbus slave. Configuration parameters such as "UID range" and UID Address Mode will be ignored in this mode of operation

2. Download the "modbus_remap" file that you created to the IOLAN using:
 - Device Manager: use "tools-advanced-custom files" dialog "download other file"
 - Web Manager: use "administration-custom files" page "other file"
 - CLI: use the command "netload customapp-file" command



Glossary

This chapter provides definitions for Device Server terms.

BOOTP (BOOTstrap Protocol)	An Internet protocol that enables a diskless workstation to discover its own IP address, the IP address of a BOOTP server on the network, and a file to be loaded into memory to boot the machine. This enables the workstation to boot without requiring a hard or floppy disk drive.
Community (SNMP)	An SNMP community is the group that devices and management stations running SNMP belong to. It helps define where information is sent.
DHCP (Dynamic Host Configuration Protocol)	A TCP/IP protocol that provides static and dynamic address allocation and management.
Direct Connection	Connections that bypass the Device Server enabling the user to log straight into a specific host. A direct connection is recommended where a user logging in to the Device Server is not required.
Ethernet	A high-speed (10Mbps,100Mbps) cable technology that connects devices to a LAN, using one or more sets of communication protocols.
Fixed Callback	A method where there is a specific number defined to callback a user.
Local Authentication	Uses the user ID and password stored within the Device Server User database.
LPD	Line Printer Daemon. A printer protocol that uses TCP/IP to establish connections between printers and workstations on a network. The technology was developed originally for BSD UNIX and has since become the de facto cross-platform printing protocol.
Modem Initialization String	A series of commands sent to the modem by a communications program at start up. These commands tell a modem how to set itself up in order to communicate easily with another modem.
MOTD	Message of the day. This is defined by a file whose contents display when users log into the Device Server.
Multicast	The broadcasting of messages to a specified group of workstations on a LAN, WAN, or internet.
NAK (Negative Acknowledgment)	A communication control character sent by the receiving destination indicating that the last message was not received correctly.
RADIUS (Remote Authentication Dial In Users Services)	An open standard network security server that communicates with the PAP protocol.
Reverse Connection	Connections that originate from a host that go directly to a serial device through the Device Server.
RIP (Routing Information Protocol)	A protocol that allows gateways and hosts to exchange information about various routes to different networks.

Roaming Callback	A method where the client supplies the number for callback when they dial in.
RPC	Remote Procedure Call. A type of protocol that allows a program on one computer to execute a program on a server computer.
Silent Connection	Silent connections are the same as direct connections except that they are permanently established. The host login prompt is displayed on the screen. Logging out redisplay this prompt. Silent connections, unlike direct connections, however, make permanent use of pseudo tty resources and therefore consume host resources even when not in use.
SNMP (Simple Network Management Protocol)	A protocol for managing network devices.
Subnet/Prefix Bits	Identifies the device's IP address, which portion constitutes the network address and which portion constitutes the host address.



Index

A

admin

- default password [47](#)
- lost password [202](#)

analog

- calibrating [194](#)

API

- I/O commands [175, 224](#)
- TruePort [174](#)

ARP-Ping, setting an IP address [50](#)

B

binary configuration file [61](#)

BOOTP

- parameters [43](#)
- setting an IP address [49](#)

C

cabling, EIA-232 [209](#)

calibrating

- analog [194](#)
- temperature [195](#)

configuration files

- formats [61](#)

connecting to the Device Server

- console mode [28](#)
- serial mode [28](#)
- setting IP address [31](#)

console mode [28](#)

custom factory default configuration [193](#)

D

DB25

- pinouts
 - female [206](#)
 - male [205](#)
- power in pin
 - female [207](#)
 - male [206](#)

DB9 male pinouts [208](#)

default admin password [47](#)

definitions [243](#)

DeviceManager

- overview [33](#)
- setting an IP address [47](#)

DHCP

- parameters [43](#)
- setting an IP address [49](#)

direct connect

- setting an IP address [48](#)

F

factory default configuration

- custom [193](#)
- original [194](#)

factory defaults, resetting to [201](#)

I

I/O

- Modbus [168](#)
- UDP [164](#)

I/O SNMP traps [179](#)

IOLAN models [20](#)

IOLAN+ interface

- Menu [40](#)

IPv6, setting an IP address [50](#)

J

jumpers

- line termination [213](#)
- setting [213](#)

L

language

- translating [199](#)
- upgrading firmware [199](#)

line termination, setting jumper [213](#)

M

medical unit

description 20

Menu

conventions 41

Menu IOLAN+ interface 40

MIB 44

Modbus

I/O access 168

TruePort 173

mode

console 28

serial 28

models, IOLAN 20

modem parameters 117

O

online help, using 4

P

parameters

BOOTP/DHCP 43

modems 117

password

admin default 47

lost 202

pin, power in

DB25 female 207

DB25 male 206

serial RJ45 207

pinouts

DB25 female 206

DB25 male 205

DB9 male 208

RJ45 serial 207

power in pin

DB25 female 207

DB25 male 206

serial RJ45 207

product repair 239

R

resetting to factory defaults 201

RJ45

serial pinouts 207

RJ45 serial power in pin 207

S

serial mode 28

services

line

signal I/O 106

UDP 87

vmodem 101

sessions 134

setting an IP address

ARP-Ping 50

BOOTP/DHCP 49

DeviceManager 47

direct connect 48

IPv6 50

signal I/O

general 106

SNMP

I/O traps 179

support MIBs 44

using 44

T

technical support

contacting 238

online 238

product information 238

product repair 239

via the internet 238

temperature

calibrating 195

terminal definitions

creating 200

downloading 200

text configuration file 61

TruePort

API 174

Modbus 173

TruePort utility 74, 223

U

UDP

configuring 87

UDP, I/O 164

user sessions 134

utility

TruePort 74, 223

V

virtual modem 101

vmodem

overview 101

W

WebManager

overview 36