



Perle IDS-105GPP (XT)

Unmanaged 10/100/1000

PoE/PoE+ Ethernet Switches



Installation Guide

P/N 5500342-10 (Rev G)

Overview

This document contains instructions necessary for the installation and operation of the Perle IDS-105GPP unmanaged Ethernet switch. This Ethernet switch operates as a 5-port RJ-45 switch with PoE/PoE+ capabilities on ports one through four. The PoE/PoE+ Ethernet ports function as (PSE) Power Sourcing Equipment and can each independently power a PD device (Powered Device) using standard UTP cables that carry Ethernet data. Powered Devices must comply with the IEEE 802.3af or the 802.3at-2009 standard for PoE or PoE+ devices. The 105GPP is available in various copper, fiber and SFP port configurations (See table below). The fiber port can be either single mode (SM) or multimode (MM) depending on the model selected and can operate over different wavelengths and distances. The SFP transceiver ports support SFP's supplied by Perle, Cisco or other manufacturers of MSA compliant SFP modules.

Visit the Perle website for the most up to date installation guides, models and specifications. <http://www.perle.com/>

Model	Port 1 -4	Port 5	Port 6	Port 7
IDS-105GPP	TP (RJ-45) PoE/PoE+	TP (RJ-45)	None	None
IDS-105GPP-xxxxxxxx	TP (RJ-45) PoE/PoE+	TP (RJ-45)	Fiber port SC or ST	Not applicable
IDS-105GPP-SFP	TP (RJ-45) PoE/PoE+	TP (RJ-45)	SFP port *	Not applicable
IDS-105GPP-DSFP	TP(RJ-45) PoE/PoE+	TP (RJ-45)	SFP port *	SFP port*
IDS-105GPP-XT (Industrial Temperature)	TP (RJ-45) PoE/PoE+	TP (RJ-45)	None	None
IDS-105GPP-SFP-XT	TP (RJ-45) PoE/PoE+	TP (RJ-45)	SFP *	Not applicable
IDS-105GPP-DSFP-XT	TP(RJ-45) PoE/PoE+	TP (RJ-45)	SFP port*	SFP port *
IDS-105GPP-xxxxxxxx-XT (Industrial Temperature)	TP(RJ-45) PoE/PoE+	TP (RJ-45)	Fiber port SC or ST	Not applicable

Note: xxxxxxxx indicates models numbers for this product line.

TP = twisted pair

XT = Industrial Temperature Models

*** fiber characteristics are determined by the SFP inserted**

Features

- 5 port 10/100/1000Base-T (RJ45) with 1 or 2 Gigabit fiber ports (SC/ST/SFP), multi/single mode
- 4 PoE/PoE+ PSE capable ports, fully compliant IEEE 802.3af/at
- Pluggable SFP transceiver ports
- Redundant dual power input 18-57 VDC
- Rugged high-strength IP30 aluminum case
- Industrial temperature models
- DIN-rail or wall/panel mounting

Note – In this guide the various models will be referred to as the IDS-105GPP

Getting to know your IDS-105GPP Switch

Package Contents:

- IDS-105GPP
- DIN-rail mounting clip (pre-installed on the unit)
- This guide

Note – optional panel/wall mounting kits may be ordered

Front View of IDS-105GPP (5 port RJ-45)

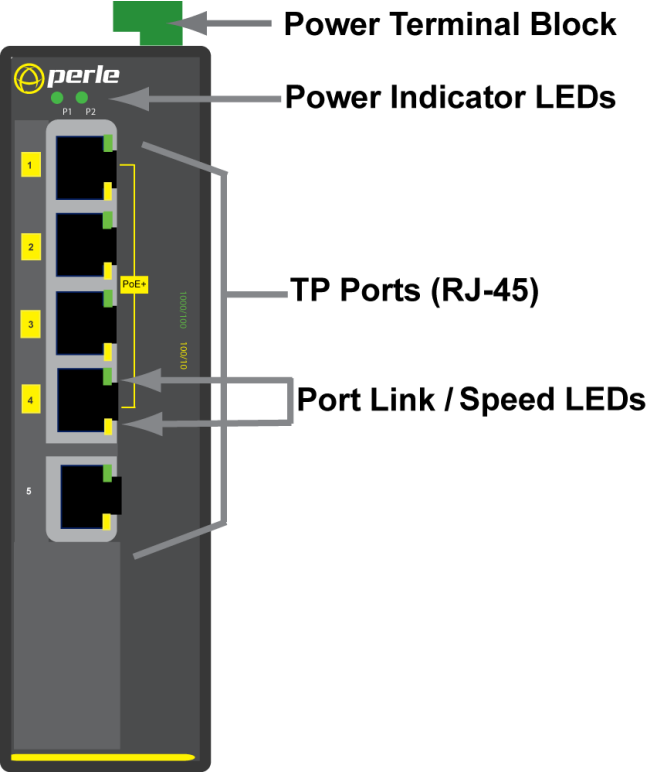

Front View of IDS-105GPP (with one / two SFP transceiver ports)

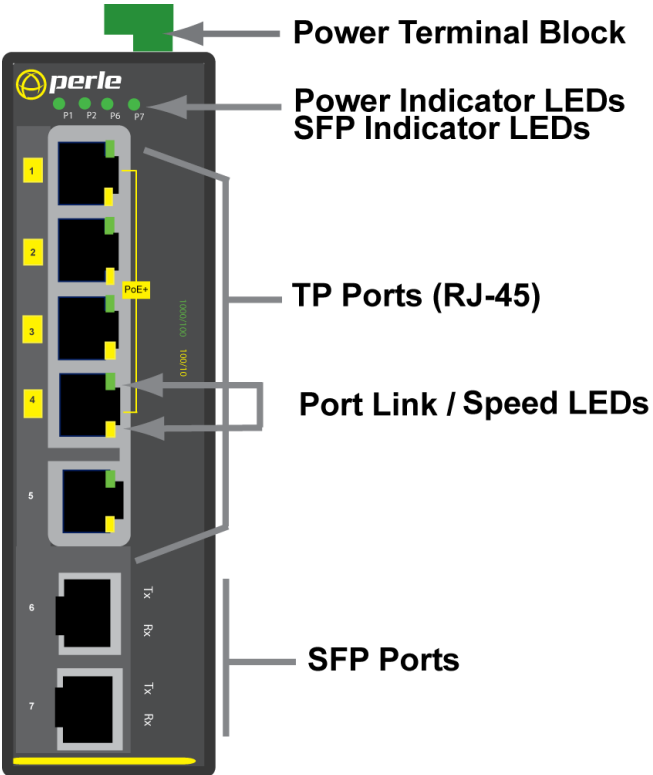

Top View of IDS-105GPP (with fiber port)

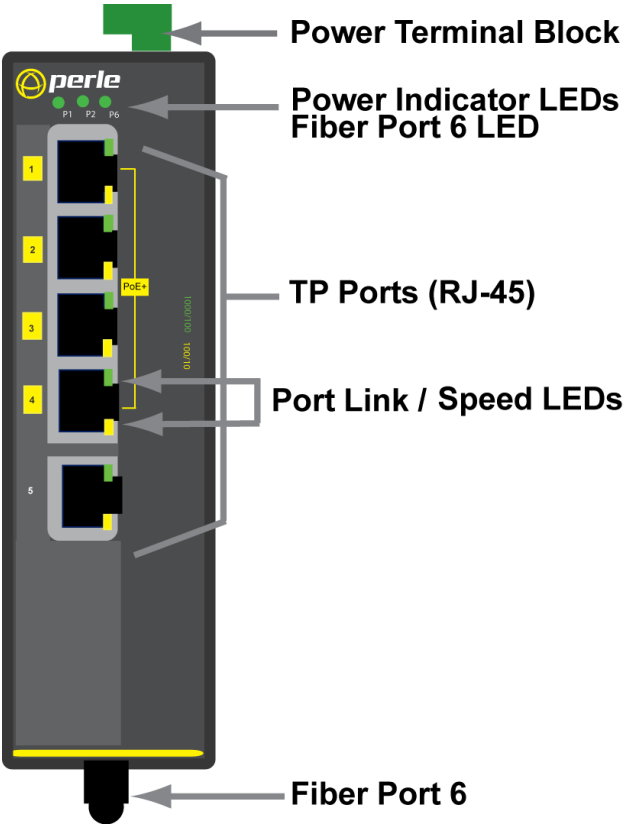

Bottom view of the IDS-105GPP (with fiber port)

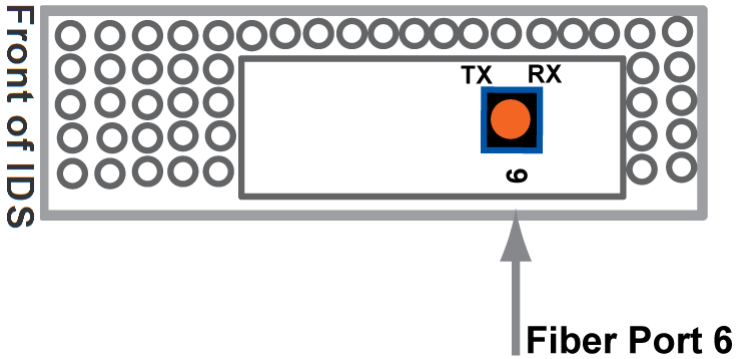

Top view of the IDS-105GPP

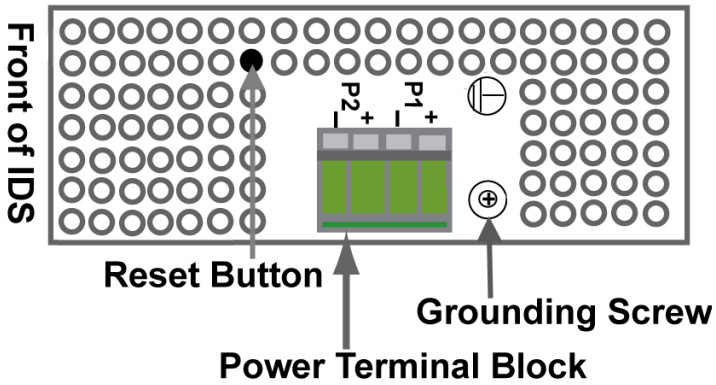

The IDS switch has two power inputs that can be connected simultaneously. If one power source fails the other source acts as a backup, and automatically powers the switch.

LED Status

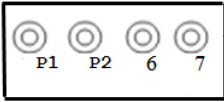

P1 / P2 – Power (Green LED)

On: Power present

Off: No Power Present

6 (Port 6 – Fiber or SFP) (Green LED)

On: Link up

Flashing: Link up and Ethernet activity detected

Off: Link down

7 (Port 7 – SFP) (Green LED)

On: Link up

Flashing: Link up and Ethernet activity detected

Off: Link down

Ethernet Port Status



Port Link / Speed (Green and Yellow LEDs)

On: Link up

- 1000 Mbps: Green On; Yellow Off
- 100 Mbps: Green On; Yellow On
- 10 Mbps: Green Off; Yellow On

Flashing: Link up and Ethernet activity detected

Off: Link Down

Views for the IDS-105GPP

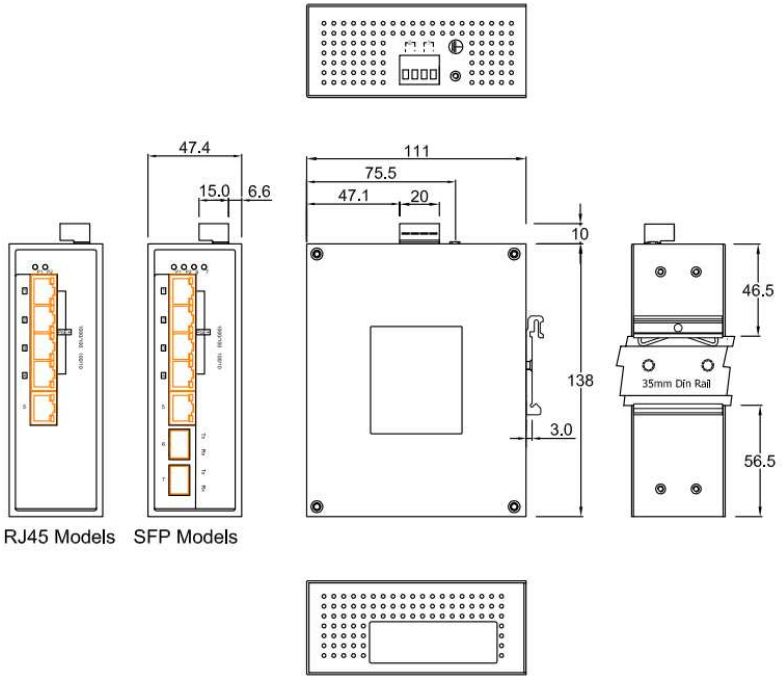

Note: all dimensions are in mm

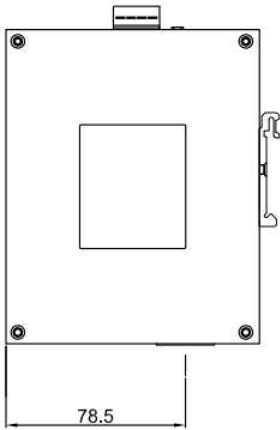

SC Models

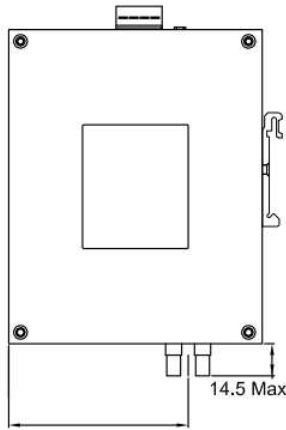
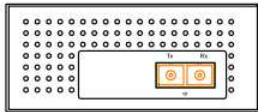

ST Models

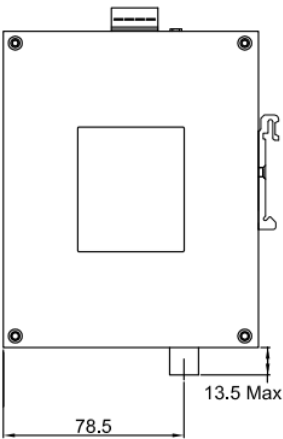
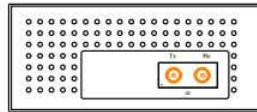

Simplex (Single strand)

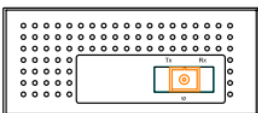

Note: all dimensions are in mm

Mounting the IDS-105GPP on a DIN-rail

1. The DIN-rail clip will be fixed to the back panel of the IDS-105GPP switch when you receive the product.
2. Position the IDS-105GPP switch such that the top of the DIN-rail fits into the slot on the top of the DIN-rail clip, just below the hook and behind the spring.
3. While pushing down on the unit to compress the spring rotate the bottom of the IDS-105GPP toward the rail. This will snap the bottom of the rail into the bottom of the clip. See diagram below.

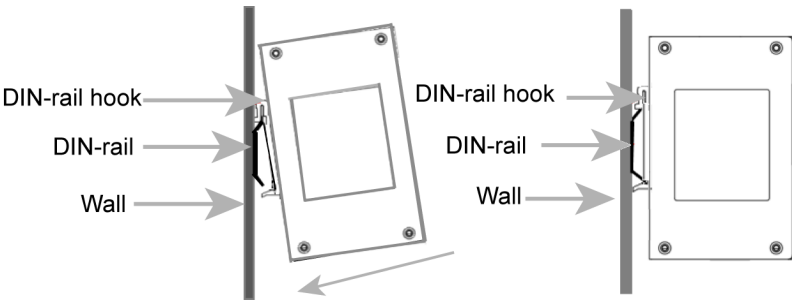

Note: To remove the IDS-105GPP switch from the DIN-rail, push down slightly on the IDS-105GPP while pulling the bottom out.

Mounting the IDS-105GPP to the Wall

1. Remove the DIN-rail clip from the rear panel on the IDS-105GPP.
2. Attach the wall mount plates to the IDS-105GPP switch as shown below using the screws provided in the kit.

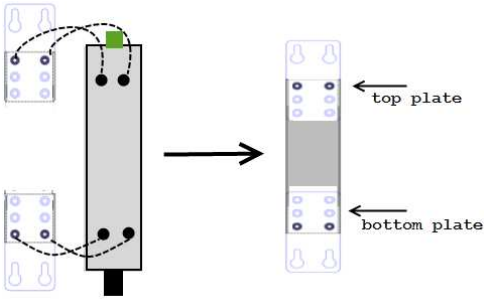

3. Use the wall mount plates as a guide to mark the spots where the screws will be.
4. Drive the screws into the wall leaving about 2 mm of the screw protruding from the wall to allow room for sliding the wall mount panel between the wall and the screws.
5. Once the screws are fixed to the wall, insert the four screw heads through the large parts of the keyhole shaped screw openings.
6. Pull the IDS down to lock the IDS-105GPP to the wall mount.
7. Tighten the four screws securely to the wall.

Note: For the best results use screws that have the following attributes:

Head diameter .5 - .6 mm

Shaft diameter 3 - 3.5 mm

Wall/Panel Mounting

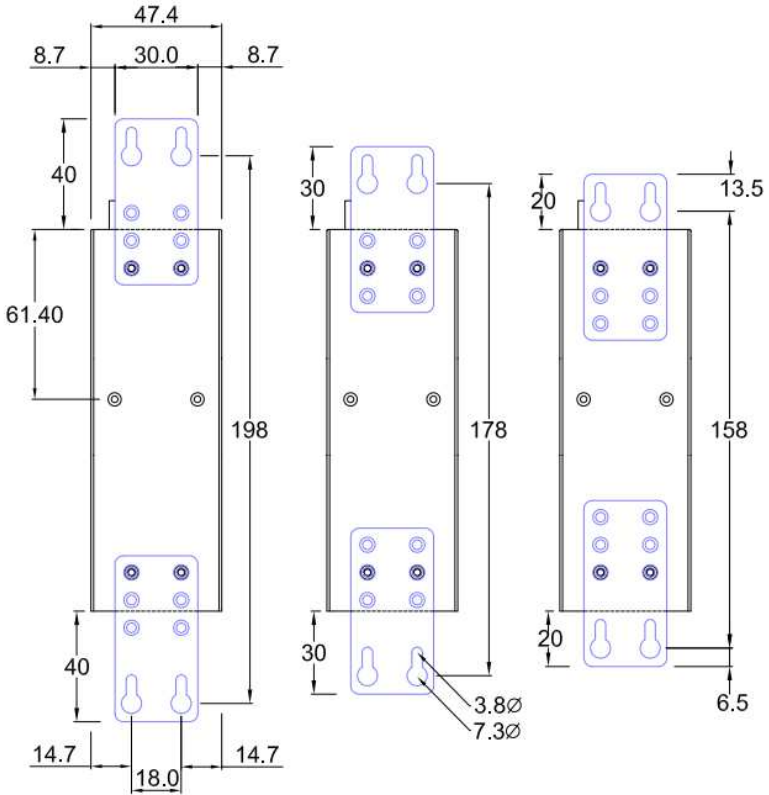

Note: the dimensions are in mm

Wiring up the IDS-105GPP



Power sources must be off prior to beginning the power connection steps.



Ensure that the voltage and current ratings of the intended power source are appropriate for the IDS-105GPP as indicated on the product label.



Ensure that the installation and electrical wiring of the equipment is performed by trained and qualified personnel and that the installation complies with all local and national electrical codes



This unit should be installed in a restricted access location where access can only be gained by service personnel or users who have been instructed about the reasons for the restrictions applied to the location and about any precautions that shall be taken; and access is through the use of a tool or lock and key, or other means of security, and is controlled by the authority responsible for the location.

Hazardous Location Warnings

(safe conditions for use:)



This equipment shall be installed in an enclosure that provides a degree of protection not less than IP54 in accordance with EN 60079-15 and accessible only by the use of a tool.



The equipment shall only be used in an area of not more than pollution degree 2, as defined in IEC 60664-1.



These devices are open-type devices that are to be installed in an enclosure with tool removable cover or door, suitable for the environment.



This equipment is suitable for use in Class I, Division 2, Groups A,B,C,D or only non hazardous locations only.



WARNING –EXPLOSION HAZARD – Do not disconnect equipment unless power has been removed or the area is known to be non-hazardous



WARNING EXPLOSION HAZARD – Substitution of any components on this switch may impair suitability for Class I, Division 2.



Transient protection shall be provided that is set at a level not exceeding 140% of the peak rated voltage value at the supply terminals to the equipment.

Connecting the IDS-105GPP to ground

If your installation requires additional grounding, follow this procedure.

Grounding the chassis requires the following items:

- One grounding lug (not provided)
 - One 12AWG wire (not provided)
1. Follow the manufacturer's instructions for attaching the ground wire to grounding lug.
 2. Attach the grounding lug to the chassis and secure with the grounding screw provided.

Connecting Power to the IDS-105GPP

1. Conductors suitable for use in an ambient temperature of 98°C must be used for the Power Supply Terminal.
2. Ensure the power source is off prior to connection.
3. Strip both (12AWG) wires 5 mm (3/16th inch).
4. Loosen the terminal block screws and connect positive (+) / negative (-) wires into the +/- terminals.
5. Tighten terminal screws (0.51Nm torque).
6. Ensure the wires are securely fastened.
7. Re-insert the Terminal block connector if removed.
8. Turn on power source.
9. Check that the P1 LED is On.
10. If desired connect P2 (power source 2, beginning at Step 1).
11. One individual conductor for each clamping point.

Connecting PoE/PoE+ devices

1. Supports IEEE 802.3af (Type 1) and IEEE 802at-2009 (Type 2) standards.
2. For PoE devices up to 15.4 Watts per port.
3. For PoE+ devices up to 30 Watts per port.

Connect the copper cables from each TP port (RJ-45) on the IDS-105GPP switch to compliant Powered Devices (PDs).

See below for RJ-45 pinouts on ports 1 through 4.

RJ-45	PoE+ Option
	Alternative A
1	positive
2	positive
3	negative
4	
5	
6	negative
7	
8	

Ethernet Copper Cabling Requirements

- Cat 5 UTP or STP, Cat 5e cables
- 24-22 AWG
- Straight through or Ethernet crossover cable

Connect the copper cables from each TP port (RJ-45) on the IDS-105GPP switch to Ethernet-enabled devices. See below for pinouts.

8-pin RJ-45

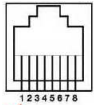

MDI Port Pinouts

Pin	Signal
1	Tx+
2	Tx-
3	Rx+
6	Rx-

MDI-X Port Pinouts

Pin	Signal
1	Rx+
2	Rx-
3	Tx+
6	Tx-

Remaining pins not used.

Fiber Port Cabling Requirements

Duplex SC or ST connector

- Multimode 50/125 or 62.5/125 micron fiber cable
- Single mode 9/125 micron fiber cable

Simplex (BIDI, single strand) SC connector

- Multimode 50/125 or 62.5/125 micron fiber cable
- Single mode 9/125 micron fiber cable

Connect the fiber cables to Port 6/7 on the IDS-105GPP and the other end to a compliant fiber devices. If you are making your own fiber cables, remember that the RX on one side needs to go to TX on the other side and vice versa. See diagram below.

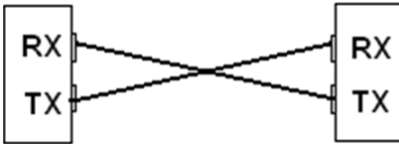

Switch Properties

- IEEE 802.3 for 10Base-T
- IEEE 802.3u for 100Base-TX
- IEEE 802.3ab for 1000Base-T
- Energy Efficient Ethernet (EEE) as per 802.3az
- IEEE 802.3x for Flow Control
- IEEE 802.3af Power Over Ethernet
- IEEE 802.3at Power Over Ethernet

Technical Specifications

Connection	
Dual input terminal block power	Power Input/Consumption 18-57 VDC 7.9A Max
Maximum Current Consumption @24VDC	3.2 Amps (4 x PoE) 5.9 Amps (4 x PoE+)
Maximum Power Consumption@24VDC	22 Watts (without PoE device attached) 76 Watts (4 X 15.4 Watts PoE) 142 Watts (4 X 30 Watts PoE+)
Reverse Polarity Protection	Yes
Interface	
RJ-45	5 shielded RJ-45 ports for 10/100/1000Base-TX up to 100 meters (328ft) 4 of these ports are PoE/PoE+ PSE capable Auto-negotiation speed F/H duplex mode and auto MDI/MDI-X connection
Fiber Ports	One or two fixed fiber ports (ST/SC). See fiber specifications.
PoE/PoE+ ports	Up to 30 Watts per port (@switch) RJ-45 driving up to four class 4 (IEEE 802.3at type 2) PDs, Alternative-A (ALT-A), MDI-X pinouts, Power over Data Pins 1,2 Pos and 3,6 Neg.
LED indicators	P1 /P2– power 1 / power 2 Ports 1-5 G/Y – Link/Activity/Speed Port 6/7 –port status (Fiber or SFP status depending on model)
Environmental	
Operating Temperature	
Commercial Models (IDS-105GPP-xxxxxxx)	0°C to 60°C (32°F to 140°F)
Industrial Models (IDS-105GPP-xxxxxxx-XT)	-40°C to 75°C (-40°F to 167°F)
Storage Temperature	
Commercial Models (IDS-105GPP-xxxxxxx)	-25°C to 70°C (-13°F to 158°F)
Industrial Models (IDS-105GPP-xxxxxxx-XT)	-40°C C to 85°C (-40°F to 185°F)
Operating Humidity	5% to 90% non-condensing
Storage Humidity	5% to 95% non-condensing
Operating Altitude	Up to 3,048 m (10,000 ft)
Regulatory Approvals	
Safety	cUL 60950-1, EN 60950-1
Industrial	UL 508
Hazardous Locations	ANSI/ISA 12.12.01-2013 Class I Division 2 Groups A-D ATEX Class I Zone 2 CENELEC EN 60079-0:2012+A11:2013 CENELEC EN 60079-15:2010 IEC 60079-0 Ed 6, Revision Date 2013-11-01 IEC 60079-15 – Edition 4 – Issue Date 2010-01-01
EMI/EMC	FCC 47 Part 15 – Class A CISPR22:2008 / EN55022:2010 Class A CISPR 24:2010/EN55024:2010





















Note: The safety certifications apply only to ambient temperatures under 60°C (140°F). However, the IDS-105GPP can function in the environmental conditions listed above.

Fiber Specifications

IDS-105GPP models	Fiber Connector	SFP transceiver ports	Mode	Distance	Wavelength (nm)	TX Power (dB)	RX Power (dB)	Budget
IDS-105GPP(-XT)	None		n/a	n/a	n/a	n/a	n/a	n/a
IDS-105GPP-SFP*(-XT)	None	one	-	-	-	-	-	-
IDS-105GPP-DSFP*(-XT)	None	two	-	-	-	-	-	-
IDS-105GPP-M2SC05(-XT)	SC	None	MM duplex	550 m 1804 ft	TX: 850 RX:850	Min:-9.5 Max:-4	Min:-17 Max:-3	7.5
IDS-105GPP-M2ST05(-XT)	ST	None	MM duplex	550 m 1804 ft	TX: 850 RX:850	Min:-9.5 Max:-4	Min:-17 Max:-3	7.5
IDS-105GPP-M2SC2	SC	None	MM duplex	2 km 1.2 miles	TX: 1310 RX:1310	Min:-6 Max:0	Min:-17 Max:-3	11
IDS-105GPP-M2ST2	ST	None	MM duplex	2 km 1.2 miles	TX: 1310 RX:1310	Min:-6 Max:0	Min:-17 Max:-3	11
IDS-105GPP-S2SC10(-XT)	SC	None	SM duplex	10 km 6.2 miles	TX: 1310 RX:1310	Min:-9.5 Max:-3	Min:-20 Max:-3	10.5
IDS-105GPP-S2ST10(-XT)	ST	None	SM duplex	10 km 6.2 miles	TX: 1310 RX:1310	Min:-9.5 Max:-3	Min:-20 Max:-3	10.5
IDS-105GPP-S1SC10U(-XT)	SC	None	SM duplex	10 km 6.2 miles	TX: 1310 RX:1490	Min:-9 Max:-3	Min:-20 Max:-3	11
IDS-105GPP-S1SC10D(-XT)	SC	None	SM duplex	10 km 6.2 miles	TX: 1490 RX:1310	Min:-9 Max:-3	Min:-20 Max:-3	11
IDS-105GPP-S1SC20U	SC	None	SM duplex	20 km 12.4 miles	TX: 1310 RX:1490	Min:-8 Max:-3	Min:-22 Max:-3	14
IDS-105GPP-S1SC20D	SC	None	SM duplex	20 km 12.4 miles	TX: 1490 RX:1310	Min:-8 Max:-3	Min:-22 Max:-3	14
IDS-105GPP-S2SC40	SC	None	SM duplex	40 km 24.9 miles	TX: 1310 RX:1310	Min:-3 Max:-5	Min:-23 Max:-3	20
IDS-105GPP-S2ST40	ST	None	SM duplex	40 km 24.9 miles	TX: 1310 RX:1310	Min:-3 Max:-5	Min:-23 Max:-3	20
IDS-105GPP-S1SC40U	SC	None	SM duplex	40 km 24.9 miles	TX: 1310 RX:1490	Min:-3 Max:-2	Min:-23 Max:-3	20
IDS-105GPP-S1SC40D	SC	None	SM duplex	40 km 24.9 miles	TX: 1490 RX:1310	Min:-3 Max:-2	Min:-23 Max:-3	20
IDS-105GPP-S2SC70	SC	None	SM duplex	70 km 43.5 miles	TX: 1550 RX:1550	Min:-2 Max:5	Min:-23 Max:-3	21
IDS-105GPP-S2ST70	ST	None	SM duplex	70 km 43.5 miles	TX: 1550 RX:1550	Min:-2 Max:5	Min:-23 Max:-3	21
IDS-105GPP-S1SC80U	ST	None	SM simplex	80 km 49.7 miles	TX: 1510 RX:1590	Min:-2 Max:3	Min:-26 Max:-3	24
IDS-105GPP-S1ST80D	ST	None	SM simplex	80 km 49.7 miles	TX: 1590 RX:1510	Min:-2 Max:3	Min:-26 Max:-3	24

IDS-105GPP models	Fiber Connector	SFP transceiver ports	Mode	Distance	Wavelength (nm)	TX Power (dB)	RX Power (dB)	Budget
IDS-105GPP-S2SC120	SC	None	SM duplex	120 km 74.6 miles	TX: 1550 RX:1550	Min:0 Max:5	Min:-32 Max:-9	32
IDS-105GPP-S2ST120	ST	None	SM duplex	120 km 74.6 miles	TX: 1550 RX:1550	Min:0 Max:5	Min:-32 Max:-9	32
IDS-105GPP-S1SC120U	SC	None	SM simplex	120 km 74.6 miles	TX: 1510 RX:1590	Min:-2 Max:3	Min:-26 Max:-3	24
IDS-105GPP-S1SC120D	ST	None	SM simplex	120 km 74.6 miles	TX: 1590 RX:1510	Min:-2 Max:3	Min:-26 Max:-3	24
IDS-105GPP-S2SC160	SC	None	SM duplex	160 km 100 miles	TX: 1550 RX:1550	Min: 0 Max:5	Min:-32 Max:-9	32
IDS-105GPP-S2ST160	ST	None	SM duplex	160 km 100 miles	TX: 1550 RX:1550	Min: 0 Max:5	Min:-32 Max:-9	32

** fiber characteristics are determined by the SFP inserted*

 Model: IDS-105GPP P/N: 07011670 S/N: 325-010315T10001       Input: 18-57VDC, 7.90A max.    <small>DEMKO 14 ATEX 1414X Ex nA IIC T3 Gc 0°C ≤ Tamb ≤ 60°C Rated Cable Temp ≥ 98°C 60 Renfrew Drive, Markham, Ontario, Canada. L3R 0E1</small> <small>IND. CONT. EQ. FOR HAZ. LOC. Class I, Division 2, Groups A, B, C and D Temp. Code T3C Max. Ambient: 60 Deg. C</small> <small>IND. CONT. EQ. Max. Surrounding Air Temp. 60 Deg. C</small> Made in Taiwan	 Model:IDS-105GPP-XT P/N: 07011940 S/N: 325-260315T10001        Input: 18-57VDC, 7.90A max.    <small>DEMKO 14 ATEX 1414X Ex nA IIC T3 Gc -40°C ≤ Tamb ≤ 75°C Rated Cable Temp ≥ 98°C 60 Renfrew Drive, Markham, Ontario, Canada. L3R 0E1</small> <small>IND. CONT. EQ. FOR HAZ. LOC. Class I, Division 2, Groups A, B, C and D Temp. Code T3C Max. Ambient: 75 Deg. C</small> <small>IND. CONT. EQ. Max. Surrounding Air Temp. 75 Deg. C</small> Made in Taiwan
---	--

For models IDS-105GPP-xxxxxxx

For models IDS-105GPP-xxxxxxx-XT

Contacting Technical Support

Contact information for the Perle Technical Assistance Center (PTAC) can be found at the link below. A Technical Support Query may be made via this web page.

www.perle.com/support_services/support_request.shtml

Warranty / Registration

This product is covered by the Perle Ethernet Switches Warranty.

Details can be found at:

http://www.perle.com/support_services/lifetime_warranty_countries.shtml